

Technical Information

Proline Promag P 500

Electromagnetic flowmeter



High-temperature flowmeter for process applications as remote version with up to 4 I/Os

Application

- The bidirectional measuring principle is virtually independent of pressure, density, temperature and viscosity
- Dedicated to chemical and process applications with corrosive liquids

Device properties

- Nominal diameter: max. DN 600 (24")
- All common Ex approvals
- Liner made of PTFE or PFA
- Remote version with up to 4 I/Os
- Backlit display with touch control and WLAN access
- Standard cable between sensor and transmitter

Your benefits

- Diverse applications – wide variety of wetted materials
- Energy-saving flow measurement – no pressure loss due to cross section constriction
- Maintenance-free – no moving parts
- Full access to process and diagnostic information – numerous, freely combinable I/Os and Ethernet
- Reduced complexity and variety – freely configurable I/O functionality
- Integrated verification – Heartbeat Technology

Table of contents





About this document	4	Environment	70
Symbols	4	Ambient temperature range	70
Function and system design	5	Storage temperature	70
Measuring principle	5	Relative humidity	70
Measuring system	6	Operating height	70
Equipment architecture	8	Degree of protection	70
Security	8	Vibration- and shock-resistance	71
Input	10	Mechanical load	71
Measured variable	10	Electromagnetic compatibility (EMC)	72
Measuring range	10	Process	72
Operable flow range	12	Medium temperature range	72
Input signal	12	Conductivity	73
Output	14	Pressure-temperature ratings	73
Output and input variants	14	Pressure tightness	75
Output signal	16	Flow limit	76
Signal on alarm	21	Pressure loss	76
Load	23	System pressure	76
Ex connection data	24	Thermal insulation	76
Low flow cut off	25	Vibrations	77
Galvanic isolation	26	Magnetism and static electricity	77
Protocol-specific data	26	Custody transfer mode	78
Power supply	32	Mechanical construction	78
Terminal assignment	32	Dimensions in SI units	78
Available device plugs	33	Dimensions in US units	88
Pin assignment, device plug	34	Weight	95
Supply voltage	36	Measuring tube specification	96
Power consumption	36	Materials	97
Current consumption	36	Fitted electrodes	100
Power supply failure	36	Process connections	100
Overcurrent protection element	36	Surface roughness	100
Electrical connection	37	Operability	100
Potential equalization	49	Operating concept	100
Terminals	52	Languages	101
Cable entries	52	Local operation	101
Cable specification	52	Remote operation	101
Overvoltage protection	57	Service interface	107
Performance characteristics	57	Network integration	109
Reference operating conditions	57	Supported operating tools	110
Maximum measured error	57	HistoROM data management	111
Repeatability	60	Certificates and approvals	113
Influence of ambient temperature	60	CE mark	113
Installation	60	UKCA marking	113
Mounting location	60	RCM mark	113
Orientation	62	Ex approval	113
Inlet and outlet runs	64	Functional safety	116
Adapters	65	HART certification	116
Length of connecting cable	65	FOUNDATION Fieldbus certification	116
Mounting the transmitter housing	67	Certification PROFIBUS	116
Special mounting instructions	69	EtherNet/IP certification	116
		Certification PROFINET	116
		Certification PROFINET with Ethernet-APL	117
		Radio approval	117

Pressure Equipment Directive	117
Additional certification	117
Other standards and guidelines	117
Ordering information	118
Application packages	118
Diagnostic functionality	118
Heartbeat Technology	118
Cleaning	119
OPC-UA Server	119
Accessories	119
Device-specific accessories	120
Communication-specific accessories	121
Service-specific accessories	122
System components	122
Supplementary documentation	123
Standard documentation	123
Supplementary device-dependent documentation	123
Registered trademarks	124





About this document

Symbols









Electrical symbols

Symbol	Meaning
	Direct current
	Alternating current
	Direct current and alternating current
	Ground connection A grounded terminal which, as far as the operator is concerned, is grounded via a grounding system.
	Potential equalization connection (PE: protective earth) Ground terminals that must be connected to ground prior to establishing any other connections. The ground terminals are located on the interior and exterior of the device: <ul style="list-style-type: none"> ▪ Interior ground terminal: potential equalization is connected to the supply network. ▪ Exterior ground terminal: device is connected to the plant grounding system.



Communication-specific symbols

Symbol	Meaning
	Wireless Local Area Network (WLAN) Communication via a wireless, local network.
	LED Light emitting diode is off.
	LED Light emitting diode is on.
	LED Light emitting diode is flashing.

Symbols for certain types of information

Symbol	Meaning
	Permitted Procedures, processes or actions that are permitted.
	Preferred Procedures, processes or actions that are preferred.
	Forbidden Procedures, processes or actions that are forbidden.
	Tip Indicates additional information.
	Reference to documentation
	Reference to page
	Reference to graphic
	Visual inspection

Symbols in graphics

Symbol	Meaning
1, 2, 3, ...	Item numbers
1, 2, 3, ...	Series of steps
A, B, C, ...	Views
A-A, B-B, C-C, ...	Sections
	Hazardous area
	Safe area (non-hazardous area)
	Flow direction

Function and system design

Measuring principle

Following *Faraday's law of magnetic induction*, a voltage is induced in a conductor moving through a magnetic field.

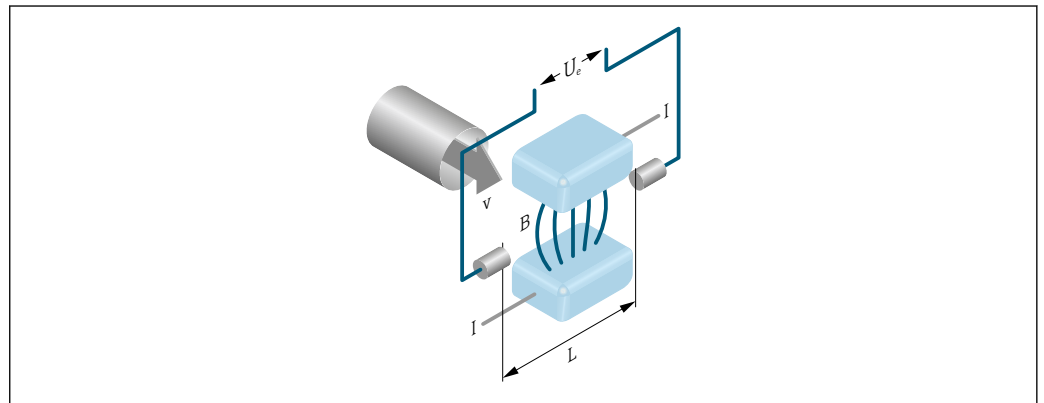

A0028962

- U_e* Induced voltage
- B* Magnetic induction (magnetic field)
- L* Electrode spacing
- I* Current
- v* Flow velocity

In the electromagnetic measuring principle, the flowing medium is the moving conductor. The voltage induced (U_e) is proportional to the flow velocity (v) and is supplied to the amplifier by means of two measuring electrodes. The flow volume (Q) is calculated via the pipe cross-section (A). The magnetic field is created through a switched direct current of alternating polarity.

Formulae for calculation

- Induced voltage $U_e = B \cdot L \cdot v$
- Volume flow $Q = A \cdot v$

Measuring system

The measuring system consists of a transmitter and a sensor. The transmitter and sensor are mounted in physically separate locations. They are interconnected by connecting cables.

Transmitter

Two versions of the transmitter are available.

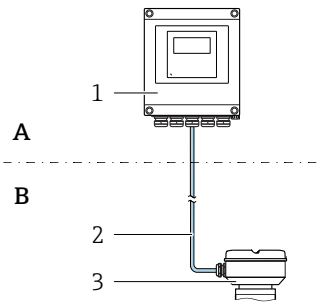
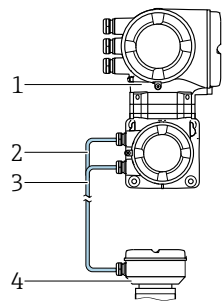

Proline 500 – digital	Proline 500
<p>For use in applications not required to meet special requirements due to ambient or operating conditions.</p>  <p>A</p> <p>B</p> <p>1 Transmitter 2 Connecting cable: cable, separate, standard 3 Sensor connection housing with integrated ISEM</p> <ul style="list-style-type: none"> ■ Flexible and cost-effective separate installation. ■ A standard cable can be used as the connecting cable. ■ Electronics in the transmitter housing, ISEM (intelligent sensor electronics module) in the sensor connection housing ■ Signal transmission: digital Order code for "Integrated ISEM electronics", option A "Sensor" 	<p>For use in applications required to meet special requirements due to ambient or operating conditions.</p>  <p>1 Transmitter with integrated ISEM 2 Coil current cable 3 Signal cable 4 Sensor connection housing</p> <p><i>Non-hazardous area or Zone 2; Class I, Division 2 or Zone 1; Class I, Division 1</i></p> <ul style="list-style-type: none"> ■ Strong vibrations at the sensor. ■ Permanent immersion of sensor in water, IP68 ingress protection. ■ Electronics and ISEM (intelligent sensor electronics module) in the transmitter housing ■ Signal transmission: analog Order code for "Integrated ISEM electronics", option B "Transmitter"
<p>Connecting cable (can be ordered in various lengths → 120)</p> <ul style="list-style-type: none"> ■ Length: max. 300 m (1000 ft) ■ Standard cable with common shield (pair-stranded) ■ Not sensitive to external EMC interference. 	
<p>Hazardous area</p> <p>Use in: Zone 2; Class I, Division 2</p> <p>Mixed installation is possible:</p> <ul style="list-style-type: none"> ■ Sensor: Zone 1; Class I, Division 1 ■ Transmitter: Zone 2; Class I, Division 2 	
<p>Housing versions and materials</p> <ul style="list-style-type: none"> ■ Transmitter housing <ul style="list-style-type: none"> ■ Aluminum, coated: aluminum, AlSi10Mg, coated ■ Material: polycarbonate ■ Material of window in transmitter housing <ul style="list-style-type: none"> ■ Aluminum, coated: glass ■ Polycarbonate: plastic 	
<p>Configuration</p> <ul style="list-style-type: none"> ■ External operation via 4-line, illuminated graphic local display (LCD) with touch control and guided menus ("Make-it-run" wizards) for application-specific commissioning. ■ Via service interface or WLAN interface: <ul style="list-style-type: none"> ■ Operating tools (e.g. FieldCare, DeviceCare) ■ Web server (access via Web browser, e.g. Microsoft Internet Explorer, Microsoft Edge) 	

Sensor connection housing

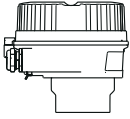
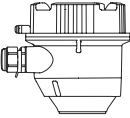
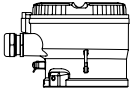
Different versions of the connection housing are available.

	<p>Order code for "Sensor connection housing", option A, "Aluminum, coated": Aluminum, AlSi10Mg, coated</p>
	<p>Order code for "Sensor connection housing", option D, "Polycarbonate": Polycarbonate</p>
	<p>Order code for "Sensor connection housing", option L, "Cast, stainless": 1.4409 (CF3M) similar to 316L</p>

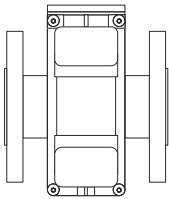
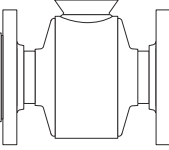
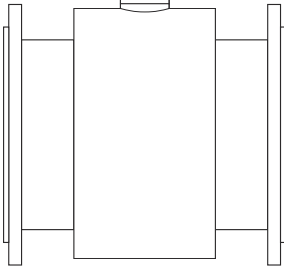
Sensor

<p>Promag P</p> <p><i>Fixed flange with aluminum half-shell housing: DN 15 to 300 mm (½ to 12 in)</i></p>  <p style="text-align: right; font-size: small;">A0017703</p> <p><i>Fixed flange with fully welded housing made of carbon steel: DN 25 to 300 mm (1 to 12 in)</i></p>  <p style="text-align: right; font-size: small;">A0022673</p> <p><i>Fixed flange with fully welded housing made of carbon steel: DN 350 to 600 mm (14 to 24 in)</i></p>  <p style="text-align: right; font-size: small;">A0017041</p>	<p>Nominal diameter range: 15 to 600 mm (½ to 24 in) Materials →  97</p>
--------------------------------------------------------------------------------------------------------------------------------------------------------------------------------------------------------------------------------------------------------------------------------------------------------------------------------------------------------------------------------------------------------------------------------------------------------------------------------------------------------------------------------------------------------------------------------------------------------------------------------------------------------------------------------------------------------------------------------------------------------------------------------------	---------------------------------------------------------------------------------------------------------------------------------------------------------------

Equipment architecture

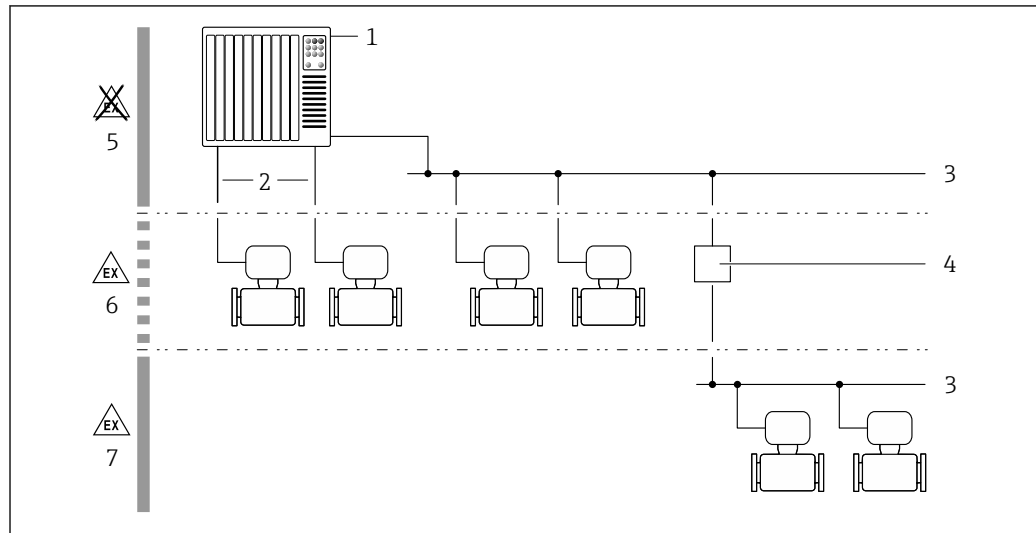

A0027512

1 Possibilities for integrating measuring devices into a system

- 1 Control system (e.g. PLC)
- 2 Connecting cable (0/4 to 20 mA HART etc.)
- 3 Fieldbus
- 4 Coupler
- 5 Non-hazardous area
- 6 Hazardous area: Zone 2; Class I, Division 2
- 7 Hazardous area: Zone 1; Class I, Division 1

Security

IT security

Our warranty is valid only if the product is installed and used as described in the Operating Instructions. The product is equipped with security mechanisms to protect it against any inadvertent changes to the settings.

IT security measures, which provide additional protection for the product and associated data transfer, must be implemented by the operators themselves in line with their security standards.

Device-specific IT security

The device offers a range of specific functions to support protective measures on the operator's side. These functions can be configured by the user and guarantee greater in-operation safety if used correctly. An overview of the most important functions is provided in the following section:

Function/interface	Factory setting	Recommendation
Write protection via hardware write protection switch → 9	Not enabled	On an individual basis following risk assessment
Access code (also applies for Web server login or FieldCare connection) → 9	Not enabled (0000)	Assign a customized access code during commissioning
WLAN (order option in display module)	Enabled	On an individual basis following risk assessment
WLAN security mode	Enabled (WPA2-PSK)	Do not change
WLAN passphrase (password) → 9	Serial number	Assign a customized WLAN passphrase during commissioning
WLAN mode	Access point	On an individual basis following risk assessment
Web server → 9	Enabled	On an individual basis following risk assessment
CDI-RJ45 service interface → 10	-	On an individual basis following risk assessment

Protecting access via hardware write protection

Write access to the parameters of the device via the local display, Web browser or operating tool (e.g. FieldCare, DeviceCare) can be disabled via a write protection switch (DIP switch on the main electronics module). When hardware write protection is enabled, only read access to the parameters is possible.

Hardware write protection is disabled when the device is delivered.

Protecting access via a password

Different passwords are available to protect write access to the device parameters or access to the device via the WLAN interface.

- **User-specific access code**
Protect write access to the device parameters via the local display, Web browser or operating tool (e.g. FieldCare, DeviceCare). Access authorization is clearly regulated through the use of a user-specific access code.
- **WLAN passphrase**
The network key protects a connection between an operating unit (e.g. notebook or tablet) and the device via the WLAN interface which can be ordered as an option.
- **Infrastructure mode**
When the device is operated in infrastructure mode, the WLAN passphrase corresponds to the WLAN passphrase configured on the operator side.

User-specific access code

Write access to the device parameters via the local display, Web browser or operating tool (e.g. FieldCare, DeviceCare) can be protected by the modifiable, user-specific access code.

WLAN passphrase: Operation as WLAN access point

A connection between an operating unit (e.g. notebook or tablet) and the device via the WLAN interface, which can be ordered as an optional extra, is protected by the network key. The WLAN authentication of the network key complies with the IEEE 802.11 standard.

When the device is delivered, the network key is pre-defined depending on the device. It can be changed via the **WLAN settings** submenu in the **WLAN passphrase** parameter.

Infrastructure mode

A connection between the device and WLAN access point is protected by means of an SSID and passphrase on the system side. Please contact the relevant system administrator for access.

General notes on the use of passwords

- The access code and network key supplied with the device should be changed during commissioning.
- Follow the general rules for generating a secure password when defining and managing the access code or network key.
- The user is responsible for the management and careful handling of the access code and network key.

Access via Web server

The device can be operated and configured via a Web browser with the integrated Web server. The connection is via the service interface (CDI-RJ45) or the WLAN interface. For device versions with the EtherNet/IP and PROFINET communication protocols, the connection can also be established via the terminal connection for signal transmission with EtherNet/IP, PROFINET (RJ45 plug) or PROFINET with Ethernet-APL (two-wire).



The Web server is enabled when the device is delivered. The Web server can be disabled if necessary (e.g. after commissioning) via the **Web server functionality** parameter.

The device and status information can be hidden on the login page. This prevents unauthorized access to the information.



For detailed information on device parameters, see:
The "Description of Device Parameters" document →  123

Access via OPC-UA

 The "OPC UA Server" application package is available in the device version with the HART communication protocol →  119.

The device can communicate with OPC UA clients using the "OPC UA Server" application package.

The OPC UA server integrated in the device can be accessed via the WLAN access point using the WLAN interface - which can be ordered as an optional extra - or the service interface (CDI-RJ45) via Ethernet network. Access rights and authorization as per separate configuration.

The following Security Modes are supported as per the OPC UA Specification (IEC 62541):

- None
- Basic128Rsa15 – signed
- Basic128Rsa15 – signed and encrypted

Access via service interface (CDI-RJ45)

The device can be connected to a network via the service interface (CDI-RJ45). Device-specific functions guarantee the secure operation of the device in a network.

The use of relevant industrial standards and guidelines that have been defined by national and international safety committees, such as IEC/ISA62443 or the IEEE, is recommended. This includes organizational security measures such as the assignment of access authorization as well as technical measures such as network segmentation.

 Transmitters with an Ex de approval may not be connected via the service interface (CDI-RJ45)!
Order code for "Approval transmitter + sensor", options (Ex de): BA, BB, C1, C2, GA, GB, MA, MB, NA, NB

 The device can be incorporated into a ring topology. The device is integrated via the terminal connection for signal transmission (output 1) and the connection to the service interface (CDI-RJ45) .

Input

Measured variable

Direct measured variables

- Volume flow (proportional to induced voltage)
- Electrical conductivity

Calculated measured variables

- Mass flow
- Corrected volume flow

Measuring range

Typically $v = 0.01$ to 10 m/s (0.03 to 33 ft/s) with the specified accuracy

Flow characteristic values in SI units: DN 15 to 125 (½ to 4")

Nominal diameter		Recommended flow min./max. full scale value ($v \sim 0.3/10$ m/s) [dm ³ /min]	Factory settings		
[mm]	[in]		Full scale value current output ($v \sim 2.5$ m/s) [dm ³ /min]	Pulse value (~ 2 pulse/s) [dm ³]	Low flow cut off ($v \sim 0.04$ m/s) [dm ³ /min]
15	½	4 to 100	25	0.2	0.5
25	1	9 to 300	75	0.5	1
32	–	15 to 500	125	1	2
40	1 ½	25 to 700	200	1.5	3
50	2	35 to 1 100	300	2.5	5
65	–	60 to 2 000	500	5	8

Nominal diameter		Recommended flow min./max. full scale value (v ~ 0.3/10 m/s) [dm ³ /min]	Factory settings		
[mm]	[in]		Full scale value current output (v ~ 2.5 m/s) [dm ³ /min]	Pulse value (~ 2 pulse/s) [dm ³]	Low flow cut off (v ~ 0.04 m/s) [dm ³ /min]
80	3	90 to 3 000	750	5	12
100	4	145 to 4 700	1200	10	20
125	-	220 to 7 500	1850	15	30

Flow characteristic values in SI units: DN 150 to 600 (6 to 24")



Nominal diameter		Recommended flow min./max. full scale value (v ~ 0.3/10 m/s) [m ³ /h]	Factory settings		
[mm]	[in]		Full scale value current output (v ~ 2.5 m/s) [m ³ /h]	Pulse value (~ 2 pulse/s) [m ³]	Low flow cut off (v ~ 0.04 m/s) [m ³ /h]
150	6	20 to 600	150	0.03	2.5
200	8	35 to 1 100	300	0.05	5
250	10	55 to 1 700	500	0.05	7.5
300	12	80 to 2 400	750	0.1	10
350	14	110 to 3 300	1000	0.1	15
400	16	140 to 4 200	1200	0.15	20
450	18	180 to 5 400	1500	0.25	25
500	20	220 to 6 600	2000	0.25	30
600	24	310 to 9 600	2500	0.3	40

Flow characteristic values in US units: ½ - 24" (DN 15 - 600)

Nominal diameter		Recommended flow min./max. full scale value (v ~ 0.3/10 m/s) [gal/min]	Factory settings		
[in]	[mm]		Full scale value current output (v ~ 2.5 m/s) [gal/min]	Pulse value (~ 2 pulse/s) [gal]	Low flow cut off (v ~ 0.04 m/s) [gal/min]
½	15	1.0 to 27	6	0.1	0.15
1	25	2.5 to 80	18	0.2	0.25
1 ½	40	7 to 190	50	0.5	0.75
2	50	10 to 300	75	0.5	1.25
3	80	24 to 800	200	2	2.5
4	100	40 to 1 250	300	2	4
6	150	90 to 2 650	600	5	12
8	200	155 to 4 850	1200	10	15
10	250	250 to 7 500	1500	15	30
12	300	350 to 10 600	2400	25	45
14	350	500 to 15 000	3600	30	60
16	400	600 to 19 000	4800	50	60

Nominal diameter		Recommended flow min./max. full scale value ($v \sim 0.3/10$ m/s)	Factory settings		
			Full scale value current output ($v \sim 2.5$ m/s)	Pulse value (~ 2 pulse/s)	Low flow cut off ($v \sim 0.04$ m/s)
[in]	[mm]	[gal/min]	[gal/min]	[gal]	[gal/min]
18	450	800 to 24 000	6000	50	90
20	500	1 000 to 30 000	7500	75	120
24	600	1 400 to 44 000	10500	100	180

Recommended measuring range

 Flow limit →  76

Operable flow range Over 1000 : 1

Input signal



Output and input variants

→  14

External measured values

To increase the accuracy of certain measured variables or to calculate the mass flow, the automation system can continuously write different measured values to the measuring device:

- Medium temperature enables temperature-compensated conductivity measurement (e.g. iTEMP)
- Reference density for calculating the mass flow

 Various pressure and temperature measuring devices can be ordered from Endress+Hauser: see "Accessories" section →  122

It is recommended to read in external measured values to calculate the corrected volume flow.

HART protocol

The measured values are written from the automation system to the measuring device via the HART protocol. The pressure transmitter must support the following protocol-specific functions:

- HART protocol
- Burst mode

Current input

The measured values are written from the automation system to the measuring device via the current input →  12.

Digital communication

The measured values can be written by the automation system via:

- FOUNDATION Fieldbus
- PROFIBUS DP
- PROFIBUS PA
- Modbus RS485
- EtherNet/IP
- PROFINET
- PROFINET with Ethernet-APL

Current input 0/4 to 20 mA

Current input	0/4 to 20 mA (active/passive)
Current span	<ul style="list-style-type: none"> ▪ 4 to 20 mA (active) ▪ 0/4 to 20 mA (passive)
Resolution	1 μ A
Voltage drop	Typically: 0.6 to 2 V for 3.6 to 22 mA (passive)

Maximum input voltage	≤ 30 V (passive)
Open-circuit voltage	≤ 28.8 V (active)
Possible input variables	<ul style="list-style-type: none"> ▪ Temperature ▪ Density

Status input

Maximum input values	<ul style="list-style-type: none"> ▪ DC -3 to 30 V ▪ If status input is active (ON): $R_i > 3 \text{ k}\Omega$
Response time	Configurable: 5 to 200 ms
Input signal level	<ul style="list-style-type: none"> ▪ Low signal: DC -3 to +5 V ▪ High signal: DC 12 to 30 V
Assignable functions	<ul style="list-style-type: none"> ▪ Off ▪ Reset the individual totalizers separately ▪ Reset all totalizers ▪ Flow override

Output

Output and input variants

Depending on the option selected for output/input 1, different options are available for the other outputs and inputs. Only one option can be selected for each output/input 1 to 4. The following tables must be read vertically (↓).

Example: If the option BA "4–20 mA HART" was selected for output/input 1, one of the options A, B, D, E, F, H, I or J is available for output 2 and one of the options A, B, D, E, F, H, I or J is available for output 3 and 4.

Output/input 1 and options for output/input 2





Options for output/input 3 and 4 → 15

Order code for "Output; input 1" (020) →	Possible options												
Current output 4 to 20 mA HART	BA												
Current output 4 to 20 mA HART Ex i passive	↓	CA											
Current output 4 to 20 mA HART Ex i active		↓	CC										
FOUNDATION Fieldbus			↓	SA									
FOUNDATION Fieldbus Ex i				↓	TA								
PROFIBUS DP					↓	LA							
PROFIBUS PA						↓	GA						
PROFIBUS PA Ex i							↓	HA					
Modbus RS485								↓	MA				
EtherNet/IP 2-port switch integrated									↓	NA			
PROFINET 2-port switch integrated										↓	RA		
PROFINET with Ethernet-APL											↓	RB	
PROFINET with Ethernet-APL Ex i												↓	RC
Order code for "Output; input 2" (021) →	↓	↓	↓	↓	↓	↓	↓	↓	↓	↓	↓	↓	↓
Not assigned	A	A	A	A	A	A	A	A	A	A	A	A	A
Current output 4 to 20 mA	B			B		B	B		B	B	B	B	
Current output 4 to 20 mA Ex i passive		C	C		C			C					C
User-configurable input/output ¹⁾	D			D		D	D		D	D	D	D	
Pulse/frequency/switch output	E			E		E	E		E	E	E	E	
Double pulse output ²⁾	F								F				
Pulse/frequency/switch output Ex i passive		G	G		G			G					G
Relay output	H			H		H	H		H	H	H	H	
Current input 0/4 to 20 mA	I			I		I	I		I	I	I	I	
Status input	J			J		J	J		J	J	J	J	

1) A specific input or output can be assigned to a user-configurable input/output → 21.

2) If double pulse output (F) is selected for output/input 2 (021), only the double pulse output (F) option is available for selection for output/input 3 (022).

Output/input 1 and options for output/input 3 and 4

 Options for output/input 2 →  14

Order code for "Output; input 1" (020) →	Possible options												
Current output 4 to 20 mA HART	BA												
Current output 4 to 20 mA HART Ex i passive	↓	CA											
Current output 4 to 20 mA HART Ex i active		↓	CC										
FOUNDATION Fieldbus			↓	SA									
FOUNDATION Fieldbus Ex i				↓	TA								
PROFIBUS DP					↓	LA							
PROFIBUS PA						↓	GA						
PROFIBUS PA Ex i							↓	HA					
Modbus RS485								↓	MA				
EtherNet/IP 2-port switch integrated									↓	NA			
PROFINET 2-port switch integrated										↓	RA		
PROFINET with Ethernet-APL											↓	RB	
PROFINET with Ethernet-APL Ex i												↓	RC
Order code for "Output; input 3" (022), "Output; input 4" (023) ¹⁾ →	↓	↓	↓	↓	↓	↓	↓	↓	↓	↓	↓	↓	↓
Not assigned	A	A	A	A	A	A	A	A	A	A	A	A	A
Current output 4 to 20 mA	B						B			B	B	B	B
Current output 4 to 20 mA Ex i passive ²⁾		C	C										
User-configurable input/output	D					D			D	D	D	D	
Pulse/frequency/switch output	E					E			E	E	E	E	
Double pulse output (slave) ³⁾	F								F				
Pulse/frequency/switch output Ex i passive ⁴⁾		G	G										
Relay output	H					H			H	H	H	H	
Current input 0/4 to 20 mA	I					I			I	I	I	I	
Status input	J					J			J	J	J	J	

- 1) The order code for "Output; input 4" (023) is only available for the Proline 500-digital transmitter, order code for "Integrated ISEM electronics", option A.
- 2) The current output 4 to 20 mA Ex i passive (C) option is not available for input/output 4.
- 3) The double pulse output (F) option is not available for input/output 4.
- 4) The pulse/frequency/switch output Ex i passive (G) option is not available for input/output 4.

Output signal

Current output 4 to 20 mA HART

Order code	"Output; input 1" (20): Option BA: current output 4 to 20 mA HART
Signal mode	Can be set to: <ul style="list-style-type: none"> ■ Active ■ Passive
Current range	Can be set to: <ul style="list-style-type: none"> ■ 4 to 20 mA NAMUR ■ 4 to 20 mA US ■ 4 to 20 mA ■ 0 to 20 mA (only if the signal mode is active) ■ Fixed current
Open-circuit voltage	DC 28.8 V (active)
Maximum input voltage	DC 30 V (passive)
Load	250 to 700 Ω
Resolution	0.38 μ A
Damping	Configurable: 0 to 999.9 s
Assignable measured variables	<ul style="list-style-type: none"> ■ Volume flow ■ Mass flow ■ Corrected volume flow ■ Flow velocity ■ Conductivity ■ Electronics temperature

Current output 4 to 20 mA HART Ex i

Order code	"Output; input 1" (20) choose from: <ul style="list-style-type: none"> ■ Option CA: current output 4 to 20 mA HART Ex i passive ■ Option CC: current output 4 to 20 mA HART Ex i active
Signal mode	Depends on the selected order version.
Current range	Can be set to: <ul style="list-style-type: none"> ■ 4 to 20 mA NAMUR ■ 4 to 20 mA US ■ 4 to 20 mA ■ 0 to 20 mA (only if the signal mode is active) ■ Fixed current
Open-circuit voltage	DC 21.8 V (active)
Maximum input voltage	DC 30 V (passive)
Load	<ul style="list-style-type: none"> ■ 250 to 400 Ω (active) ■ 250 to 700 Ω (passive)
Resolution	0.38 μ A
Damping	Configurable: 0 to 999.9 s
Assignable measured variables	<ul style="list-style-type: none"> ■ Volume flow ■ Mass flow ■ Corrected volume flow ■ Flow velocity ■ Conductivity ■ Electronics temperature

FOUNDATION Fieldbus

FOUNDATION Fieldbus	H1, IEC 61158-2, galvanically isolated
Data transfer	31.25 kbit/s

Current consumption	10 mA
Permitted supply voltage	9 to 32 V
Bus connection	With integrated reverse polarity protection

PROFIBUS DP

Signal encoding	NRZ code
Data transfer	9.6 kBaud...12 MBaud
Terminating resistor	Integrated, can be activated via DIP switches

PROFIBUS PA

PROFIBUS PA	In accordance with EN 50170 Volume 2, IEC 61158-2 (MBP), galvanically isolated
Data transmission	31.25 kbit/s
Current consumption	10 mA
Permitted supply voltage	9 to 32 V
Bus connection	With integrated reverse polarity protection

Modbus RS485

Physical interface	RS485 in accordance with EIA/TIA-485 standard
Terminating resistor	Integrated, can be activated via DIP switches

EtherNet/IP

Standards	In accordance with IEEE 802.3
------------------	-------------------------------

PROFINET

Standards	In accordance with IEEE 802.3
------------------	-------------------------------

PROFINET with Ethernet-APL

Device use	<p>Device connection to an APL field switch</p> <p>The device may only be operated according to the following APL port classifications:</p> <ul style="list-style-type: none"> ▪ If used in hazardous areas: SLAA or SLAC ¹⁾ ▪ If used in non-hazardous areas: SLAX <p>Connection values of APL field switch (corresponds to APL port classification SPCC or SPAA, for instance):</p> <ul style="list-style-type: none"> ▪ Maximum input voltage: 15 V_{DC} ▪ Minimum output values: 0.54 W <p>Device connection to an SPE switch</p> <p>The device may only be operated according to the following PoDL power class: If used in the non-hazardous area: PoDL power class 10</p> <p>Connection values of SPE switch (corresponds to PoDL power class 10, 11 or 12):</p> <ul style="list-style-type: none"> ▪ Maximum input voltage: 30 V_{DC} ▪ Minimum output values: 1.85 W
PROFINET	According to IEC 61158 and IEC 61784

Ethernet-APL	According to IEEE 802.3cg, APL port profile specification v1.0, galvanically isolated
Data transfer	10 Mbit/s
Current consumption	Transmitter <ul style="list-style-type: none"> ▪ Max. 400 mA(24 V) ▪ Max. 200 mA (110 V, 50/60 Hz; 230 V, 50/60 Hz)
Permitted supply voltage	9 to 30 V
Network connection	With integrated reverse polarity protection

1) For more information on using the device in the hazardous area, see the Ex-specific Safety Instructions

Current output 4 to 20 mA

Order code	"Output; input 2" (21), "Output; input 3" (022) or "Output; input 4" (023): Option B: current output 4 to 20 mA
Signal mode	Can be set to: <ul style="list-style-type: none"> ▪ Active ▪ Passive
Current span	Can be set to: <ul style="list-style-type: none"> ▪ 4 to 20 mA NAMUR ▪ 4 to 20 mA US ▪ 4 to 20 mA ▪ 0 to 20 mA (only if the signal mode is active) ▪ Fixed current
Maximum output values	22.5 mA
Open-circuit voltage	DC 28.8 V (active)
Maximum input voltage	DC 30 V (passive)
Load	0 to 700 Ω
Resolution	0.38 μ A
Damping	Configurable: 0 to 999.9 s
Assignable measured variables	<ul style="list-style-type: none"> ▪ Volume flow ▪ Mass flow ▪ Corrected volume flow ▪ Flow velocity ▪ Conductivity ▪ Electronics temperature

Current output 4 to 20 mA Ex i passive

Order code	"Output; input 2" (21), "Output; input 3" (022): Option C: current output 4 to 20 mA Ex i passive
Signal mode	Passive
Current span	Can be set to: <ul style="list-style-type: none"> ▪ 4 to 20 mA NAMUR ▪ 4 to 20 mA US ▪ 4 to 20 mA ▪ Fixed current
Maximum output values	22.5 mA
Maximum input voltage	DC 30 V
Load	0 to 700 Ω
Resolution	0.38 μ A

Damping	Configurable: 0 to 999 s
Assignable measured variables	<ul style="list-style-type: none"> ▪ Volume flow ▪ Mass flow ▪ Corrected volume flow ▪ Flow velocity ▪ Conductivity ▪ Electronics temperature

Pulse/frequency/switch output

Function	Can be configured as pulse, frequency or switch output
Version	Open collector Can be set to: <ul style="list-style-type: none"> ▪ Active ▪ Passive ▪ Passive NAMUR  Ex-i, passive
Maximum input values	DC 30 V, 250 mA (passive)
Open-circuit voltage	DC 28.8 V (active)
Voltage drop	For 22.5 mA: ≤ DC 2 V
Pulse output	
Maximum input values	DC 30 V, 250 mA (passive)
Maximum output current	22.5 mA (active)
Open-circuit voltage	DC 28.8 V (active)
Pulse width	Configurable: 0.05 to 2 000 ms
Maximum pulse rate	10 000 Impulse/s
Pulse value	Configurable
Assignable measured variables	<ul style="list-style-type: none"> ▪ Volume flow ▪ Mass flow ▪ Corrected volume flow
Frequency output	
Maximum input values	DC 30 V, 250 mA (passive)
Maximum output current	22.5 mA (active)
Open-circuit voltage	DC 28.8 V (active)
Output frequency	Configurable: end value frequency 2 to 10 000 Hz ($f_{max} = 12\,500$ Hz)
Damping	Configurable: 0 to 999.9 s
Pulse/pause ratio	1:1
Assignable measured variables	<ul style="list-style-type: none"> ▪ Volume flow ▪ Mass flow ▪ Corrected volume flow ▪ Flow velocity ▪ Conductivity ▪ Electronics temperature
Switch output	
Maximum input values	DC 30 V, 250 mA (passive)
Open-circuit voltage	DC 28.8 V (active)
Switching behavior	Binary, conductive or non-conductive
Switching delay	Configurable: 0 to 100 s

Number of switching cycles	Unlimited
Assignable functions	<ul style="list-style-type: none"> ▪ Off ▪ On ▪ Diagnostic behavior ▪ Limit value: <ul style="list-style-type: none"> ▪ Off ▪ Volume flow ▪ Mass flow ▪ Corrected volume flow ▪ Flow velocity ▪ Conductivity ▪ Totalizer 1-3 ▪ Electronics temperature ▪ Flow direction monitoring ▪ Status <ul style="list-style-type: none"> ▪ Empty pipe detection ▪ Buildup index ▪ HBSI limit value exceeded ▪ Low flow cut off

Double pulse output

Function	Double pulse
Version	Open collector Can be set to: <ul style="list-style-type: none"> ▪ Active ▪ Passive ▪ Passive NAMUR
Maximum input values	DC 30 V, 250 mA (passive)
Open-circuit voltage	DC 28.8 V (active)
Voltage drop	For 22.5 mA: ≤ DC 2 V
Output frequency	Configurable: 0 to 1000 Hz
Damping	Configurable: 0 to 999 s
Pulse/pause ratio	1:1
Assignable measured variables	<ul style="list-style-type: none"> ▪ Volume flow ▪ Mass flow ▪ Corrected volume flow ▪ Flow velocity ▪ Conductivity ▪ Electronics temperature

Relay output

Function	Switch output
Version	Relay output, galvanically isolated
Switching behavior	Can be set to: <ul style="list-style-type: none"> ▪ NO (normally open), factory setting ▪ NC (normally closed)

Maximum switching capacity (passive)	<ul style="list-style-type: none"> ▪ DC 30 V, 0.1 A ▪ AC 30 V, 0.5 A
Assignable functions	<ul style="list-style-type: none"> ▪ Off ▪ On ▪ Diagnostic behavior ▪ Limit value: <ul style="list-style-type: none"> ▪ Off ▪ Volume flow ▪ Mass flow ▪ Corrected volume flow ▪ Flow velocity ▪ Conductivity ▪ Totalizer 1-3 ▪ Electronics temperature ▪ Flow direction monitoring ▪ Status <ul style="list-style-type: none"> ▪ Empty pipe detection ▪ Buildup index ▪ HBSI limit value exceeded ▪ Low flow cut off

User-configurable input/output

One specific input or output is assigned to a user-configurable input/output (configurable I/O) during device commissioning.

The following inputs and outputs are available for assignment:

- Choice of current output: 4 to 20 mA (active), 0/4 to 20 mA (passive)
- Pulse/frequency/switch output
- Choice of current input: 4 to 20 mA (active), 0/4 to 20 mA (passive)
- Status input

The technical values correspond to those of the inputs and outputs described in this section.

Signal on alarm

Depending on the interface, failure information is displayed as follows:

HART current output

Device diagnostics	Device condition can be read out via HART Command 48
---------------------------	------------------------------------------------------

PROFIBUS PA

Status and alarm messages	Diagnostics in accordance with PROFIBUS PA Profile 3.02
Failure current FDE (Fault Disconnection Electronic)	0 mA

PROFIBUS DP

Status and alarm messages	Diagnostics in accordance with PROFIBUS PA Profile 3.02
----------------------------------	---------------------------------------------------------

EtherNet/IP

Device diagnostics	Device condition can be read out in Input Assembly
---------------------------	----------------------------------------------------

PROFINET

Device diagnostics	According to "Application Layer protocol for decentralized periphery", Version 2.3
---------------------------	------------------------------------------------------------------------------------

PROFINET with Ethernet-APL

Device diagnostics	Diagnostics according to PROFINET PA Profile 4
--------------------	------------------------------------------------

FOUNDATION Fieldbus

Status and alarm messages	Diagnostics in accordance with FF-891
Failure current FDE (Fault Disconnection Electronic)	0 mA

Modbus RS485

Failure mode	Choose from: <ul style="list-style-type: none"> ▪ NaN value instead of current value ▪ Last valid value
--------------	---------------------------------------------------------------------------------------------------------------------------------

Current output 0/4 to 20 mA*4 to 20 mA*

Failure mode	Choose from: <ul style="list-style-type: none"> ▪ 4 to 20 mA in accordance with NAMUR recommendation NE 43 ▪ 4 to 20 mA in accordance with US ▪ Min. value: 3.59 mA ▪ Max. value: 22.5 mA ▪ Freely definable value between: 3.59 to 22.5 mA ▪ Actual value ▪ Last valid value
--------------	----------------------------------------------------------------------------------------------------------------------------------------------------------------------------------------------------------------------------------------------------------------------------------------------------------------------------------------------------

0 to 20 mA

Failure mode	Choose from: <ul style="list-style-type: none"> ▪ Maximum alarm: 22 mA ▪ Freely definable value between: 0 to 20.5 mA
--------------	-----------------------------------------------------------------------------------------------------------------------------------------------

Pulse/frequency/switch output

Pulse output	
Failure mode	Choose from: <ul style="list-style-type: none"> ▪ Actual value ▪ No pulses
Frequency output	
Failure mode	Choose from: <ul style="list-style-type: none"> ▪ Actual value ▪ 0 Hz ▪ Defined value (f_{\max} 2 to 12 500 Hz)
Switch output	
Failure mode	Choose from: <ul style="list-style-type: none"> ▪ Current status ▪ Open ▪ Closed

Relay output

Failure mode	Choose from: <ul style="list-style-type: none"> ▪ Current status ▪ Open ▪ Closed
---------------------	-------------------------------------------------------------------------------------------------------------------

Local display



Plain text display	With information on cause and remedial measures
Backlight	Red backlighting indicates a device error.

 Status signal as per NAMUR recommendation NE 107

Interface/protocol

- Via digital communication:
 - HART protocol
 - FOUNDATION Fieldbus
 - PROFIBUS PA
 - PROFIBUS DP
 - Modbus RS485
 - EtherNet/IP
 - PROFINET
 - PROFINET with Ethernet-APL
- Via service interface
 - CDI-RJ45 service interface
 - WLAN interface

Plain text display	With information on cause and remedial measures
---------------------------	-------------------------------------------------

 Additional information on remote operation →  101

Web browser

Plain text display	With information on cause and remedial measures
---------------------------	-------------------------------------------------

Light emitting diodes (LED)

Status information	Status indicated by various light emitting diodes The following information is displayed depending on the device version: <ul style="list-style-type: none"> ▪ Supply voltage active ▪ Data transmission active ▪ Device alarm/error has occurred ▪ EtherNet/IP network available ▪ EtherNet/IP connection established ▪ PROFINET network available ▪ PROFINET connection established ▪ PROFINET blinking feature
---------------------------	----------------------------------------------------------------------------------------------------------------------------------------------------------------------------------------------------------------------------------------------------------------------------------------------------------------------------------------------------------------------------------------------------------------------------------------------------------------------------------------------------

Load

Output signal →  16

Ex connection data

Safety-related values

Order code for "Output; input 1"	Output type	Safety-related values "Output; input 1"	
		26 (+)	27 (-)
Option BA	Current output 4 to 20 mA HART	$U_N = 30 V_{DC}$ $U_M = 250 V_{AC}$	
Option GA	PROFIBUS PA	$U_N = 32 V_{DC}$ $U_M = 250 V_{AC}$	
Option LA	PROFIBUS DP	$U_N = 32 V_{DC}$ $U_M = 250 V_{AC}$	
Option MA	Modbus RS485	$U_N = 30 V_{DC}$ $U_M = 250 V_{AC}$	
Option SA	FOUNDATION Fieldbus	$U_N = 32 V_{DC}$ $U_M = 250 V_{AC}$	
Option NA	EtherNet/IP	$U_N = 30 V_{DC}$ $U_M = 250 V_{AC}$	
Option RA	PROFINET	$U_N = 30 V_{DC}$ $U_M = 250 V_{AC}$	
Option RB	PROFINET with Ethernet- APL	APL port profile SLAX SPE PoDL classes 10, 11, 12 $U_N = 30 V_{DC}$ $U_M = 250 V_{AC}$	

Order code for "Output; input 2"; "Output; input 3"; "Output; input 4"	Output type	Safety-related values					
		Output; input 2		Output; input 3		Output; input 4 ¹⁾	
		24 (+)	25 (-)	22 (+)	23 (-)	20 (+)	21 (-)
Option B	Current output 4 to 20 mA	$U_N = 30 V_{DC}$ $U_M = 250 V_{AC}$					
Option D	User-configurable input/ output	$U_N = 30 V_{DC}$ $U_M = 250 V_{AC}$					
Option E	Pulse/frequency/switch output	$U_N = 30 V_{DC}$ $U_M = 250 V_{AC}$					
Option F	Double pulse output	$U_N = 30 V_{DC}$ $U_M = 250 V_{AC}$					
Option H	Relay output	$U_N = 30 V_{DC}$ $I_N = 100 mA_{DC} / 500 mA_{AC}$ $U_M = 250 V_{AC}$					
Option I	Current input 4 to 20 mA	$U_N = 30 V_{DC}$ $U_M = 250 V_{AC}$					
Option J	Status input	$U_N = 30 V_{DC}$ $U_M = 250 V_{AC}$					

1) The order code "Output; input 4" is only available for the Proline 500 – digital transmitter.

Intrinsically safe values

Order code "Output; input 1"	Output type	Intrinsically safe values "Output; input 1"	
		26 (+)	27 (-)
Option CA	Current output 4 to 20 mA HART Ex i passive	$U_i = 30\text{ V}$ $I_i = 100\text{ mA}$ $P_i = 1.25\text{ W}$ $L_i = 0\text{ }\mu\text{H}$ $C_i = 6\text{ nF}$	
Option CC	Current output 4 to 20 mA HART Ex i active	Ex ia ¹⁾ $U_0 = 21.8\text{ V}$ $I_0 = 90\text{ mA}$ $P_0 = 491\text{ mW}$ $L_0 = 4.1\text{ mH (IIC)}/15\text{ mH (IIB)}$ $C_0 = 160\text{ nF (IIC)}/1160\text{ nF (IIB)}$ $U_i = 30\text{ V}$ $I_i = 10\text{ mA}$ $P_i = 0.3\text{ W}$ $L_i = 5\text{ }\mu\text{H}$ $C_i = 6\text{ nF}$	Ex ic ²⁾ $U_0 = 21.8\text{ V}$ $I_0 = 90\text{ mA}$ $P_0 = 491\text{ mW}$ $L_0 = 9\text{ mH (IIC)}/39\text{ mH (IIB)}$ $C_0 = 600\text{ nF (IIC)}/4000\text{ nF (IIB)}$
Option HA	PROFIBUS PA Ex i (FISCO Field Device)	Ex ia ¹⁾ $U_i = 30\text{ V}$ $I_i = 570\text{ mA}$ $P_i = 8.5\text{ W}$ $L_i = 10\text{ }\mu\text{H}$ $C_i = 5\text{ nF}$	Ex ic ²⁾ $U_i = 32\text{ V}$ $I_i = 570\text{ mA}$ $P_i = 8.5\text{ W}$ $L_i = 10\text{ }\mu\text{H}$ $C_i = 5\text{ nF}$
Option TA	FOUNDATION Fieldbus Ex i	Ex ia ¹⁾ $U_i = 30\text{ V}$ $I_i = 570\text{ mA}$ $P_i = 8.5\text{ W}$ $L_i = 10\text{ }\mu\text{H}$ $C_i = 5\text{ nF}$	Ex ic ²⁾ $U_i = 32\text{ V}$ $I_i = 570\text{ mA}$ $P_i = 8.5\text{ W}$ $L_i = 10\text{ }\mu\text{H}$ $C_i = 5\text{ nF}$
Option RC	PROFINET with Ethernet- APL Ex i	Ex ia ¹⁾ 2-WISE power load APL port profile SLAA	Ex ic ²⁾ 2-WISE power load APL port profile SLAC

- 1) Only available for Proline 500 transmitter Zone 1; Class I, Division 1.
- 2) Only available for transmitter Zone 2; Class I, Division 2 and only for Proline 500 – digital transmitter

Order code for "Output; input 2"; "Output; input 3"; "Output; input 4"	Output type	Intrinsically safe values or NIFW values					
		Output; input 2		Output; input 3		Output; input 4 ₁₎	
		24 (+)	25 (-)	22 (+)	23 (-)	20 (+)	21 (-)
Option C	Current output 4 to 20 mA Ex i passive	$U_i = 30\text{ V}$ $I_i = 100\text{ mA}$ $P_i = 1.25\text{ W}$ $L_i = 0$ $C_i = 0$					
Option G	Pulse/frequency/switch output Ex i passive	$U_i = 30\text{ V}$ $I_i = 100\text{ mA}$ $P_i = 1.25\text{ W}$ $L_i = 0$ $C_i = 0$					

- 1) The order code "Output; input 4" is only available for the Proline 500 – digital transmitter.

Low flow cut off

The switch points for low flow cut off are user-selectable.

Galvanic isolation

The outputs are galvanically isolated:

- from the power supply
- from one another
- from the potential equalization (PE) terminal

Protocol-specific data**HART**



Manufacturer ID	0x11
Device type ID	0x3C
HART protocol revision	7
Device description files (DTM, DD)	Information and files under: www.endress.com
HART load	Min. 250 Ω
System integration	Information on system integration: Operating Instructions →  123. <ul style="list-style-type: none"> ▪ Measured variables via HART protocol ▪ Burst Mode functionality

FOUNDATION Fieldbus

Manufacturer ID	0x452B48 (hex)
Ident number	0x103C (hex)
Device revision	1
DD revision	Information and files under:
CFF revision	<ul style="list-style-type: none"> ▪ www.endress.com ▪ www.fieldcommgroup.org
Interoperability Test Kit (ITK)	Version 6.2.0
ITK Test Campaign Number	Information: <ul style="list-style-type: none"> ▪ www.endress.com ▪ www.fieldcommgroup.org
Link Master capability (LAS)	Yes
Choice of "Link Master" and "Basic Device"	Yes Factory setting: Basic Device
Node address	Factory setting: 247 (0xF7)
Supported functions	The following methods are supported: <ul style="list-style-type: none"> ▪ Restart ▪ ENP Restart ▪ Diagnostic ▪ Set to OOS ▪ Set to AUTO ▪ Read trend data ▪ Read event logbook
Virtual Communication Relationships (VCRs)	
Number of VCRs	44
Number of link objects in VFD	50
Permanent entries	1
Client VCRs	0
Server VCRs	10
Source VCRs	43
Sink VCRs	0
Subscriber VCRs	43
Publisher VCRs	43



Device Link Capabilities	
Slot time	4
Min. delay between PDU	8
Max. response delay	16
System integration	Information regarding system integration: Operating Instructions →  123. <ul style="list-style-type: none"> ▪ Cyclic data transmission ▪ Description of the modules ▪ Execution times ▪ Methods

PROFIBUS DP

Manufacturer ID	0x11
Ident number	0x1570
Profile version	3.02
Device description files (GSD, DTM, DD)	Information and files under: <ul style="list-style-type: none"> ▪ https://www.endress.com/download On the device product page: PRODUCTS → Product Finder → Links ▪ https://www.profibus.com
Supported functions	<ul style="list-style-type: none"> ▪ Identification & Maintenance Simplest device identification on the part of the control system and nameplate ▪ PROFIBUS upload/download Reading and writing parameters is up to ten times faster with PROFIBUS upload/download ▪ Condensed status Simplest and self-explanatory diagnostic information by categorizing diagnostic messages that occur
Configuration of the device address	<ul style="list-style-type: none"> ▪ DIP switches on the I/O electronics module ▪ Via operating tools (e.g. FieldCare)
Compatibility with earlier model	<p>If the device is replaced, the measuring device Promag 500 supports the compatibility of the cyclic data with previous models. It is not necessary to adjust the engineering parameters of the PROFIBUS network with the Promag 500 GSD file.</p> <p>Earlier models:</p> <ul style="list-style-type: none"> ▪ Promag 50 PROFIBUS DP <ul style="list-style-type: none"> ▪ ID No.: 1546 (hex) ▪ Extended GSD file: EH3x1546.gsd ▪ Standard GSD file: EH3_1546.gsd ▪ Promag 53 PROFIBUS DP <ul style="list-style-type: none"> ▪ ID No.: 1526 (hex) ▪ Extended GSD file: EH3x1526.gsd ▪ Standard GSD file: EH3_1526.gsd <p> Description of the function scope of compatibility: Operating Instructions →  123.</p>
System integration	Information regarding system integration: Operating Instructions →  123. <ul style="list-style-type: none"> ▪ Cyclic data transmission ▪ Block model ▪ Description of the modules





PROFIBUS PA

Manufacturer ID	0x11
Ident number	0x156C
Profile version	3.02

Device description files (GSD, DTM, DD)	Information and files under: <ul style="list-style-type: none"> ▪ https://www.endress.com/download On the device product page: PRODUCTS → Product Finder → Links ▪ https://www.profibus.com
Supported functions	<ul style="list-style-type: none"> ▪ Identification & Maintenance Simplest device identification on the part of the control system and nameplate ▪ PROFIBUS upload/download Reading and writing parameters is up to ten times faster with PROFIBUS upload/download ▪ Condensed status Simplest and self-explanatory diagnostic information by categorizing diagnostic messages that occur
Configuration of the device address	<ul style="list-style-type: none"> ▪ DIP switches on the I/O electronics module ▪ Local display ▪ Via operating tools (e.g. FieldCare)
Compatibility with earlier model	<p>If the device is replaced, the measuring device Promag 500 supports the compatibility of the cyclic data with previous models. It is not necessary to adjust the engineering parameters of the PROFIBUS network with the Promag 500 GSD file.</p> <p>Earlier models:</p> <ul style="list-style-type: none"> ▪ Promag 50 PROFIBUS PA <ul style="list-style-type: none"> ▪ ID No.: 1525 (hex) ▪ Extended GSD file: EH3x1525.gsd ▪ Standard GSD file: EH3_1525.gsd ▪ Promag 53 PROFIBUS PA <ul style="list-style-type: none"> ▪ ID No.: 1527 (hex) ▪ Extended GSD file: EH3x1527.gsd ▪ Standard GSD file: EH3_1527.gsd <p> Description of the function scope of compatibility: Operating Instructions →  123.</p>
System integration	<p>Information regarding system integration: Operating Instructions →  123.</p> <ul style="list-style-type: none"> ▪ Cyclic data transmission ▪ Block model ▪ Description of the modules

Modbus RS485

Protocol	Modbus Applications Protocol Specification V1.1
Response times	<ul style="list-style-type: none"> ▪ Direct data access: typically 25 to 50 ms ▪ Auto-scan buffer (data range): typically 3 to 5 ms
Device type	Slave
Slave address range	1 to 247
Broadcast address range	0
Function codes	<ul style="list-style-type: none"> ▪ 03: Read holding register ▪ 04: Read input register ▪ 06: Write single registers ▪ 08: Diagnostics ▪ 16: Write multiple registers ▪ 23: Read/write multiple registers
Broadcast messages	<p>Supported by the following function codes:</p> <ul style="list-style-type: none"> ▪ 06: Write single registers ▪ 16: Write multiple registers ▪ 23: Read/write multiple registers

Supported baud rate	<ul style="list-style-type: none"> ▪ 1 200 BAUD ▪ 2 400 BAUD ▪ 4 800 BAUD ▪ 9 600 BAUD ▪ 19 200 BAUD ▪ 38 400 BAUD ▪ 57 600 BAUD ▪ 115 200 BAUD
Data transfer mode	<ul style="list-style-type: none"> ▪ ASCII ▪ RTU
Data access	<p>Each device parameter can be accessed via Modbus RS485.</p> <p> For Modbus register information</p>
Compatibility with earlier model	<p>If the device is replaced, the measuring device Promag 500 supports the compatibility of the Modbus registers for the process variables and the diagnostic information with the previous model Promag 53. It is not necessary to change the engineering parameters in the automation system.</p> <p> Description of the function scope of compatibility: Operating Instructions →  123.</p>
System integration	<p>Information on system integration: Operating Instructions →  123.</p> <ul style="list-style-type: none"> ▪ Modbus RS485 information ▪ Function codes ▪ Register information ▪ Response time ▪ Modbus data map

EtherNet/IP

Protocol	<ul style="list-style-type: none"> ▪ The CIP Networks Library Volume 1: Common Industrial Protocol ▪ The CIP Networks Library Volume 2: EtherNet/IP Adaptation of CIP
Communication type	<ul style="list-style-type: none"> ▪ 10Base-T ▪ 100Base-TX
Device profile	Generic device (product type: 0x2B)
Manufacturer ID	0x000049E
Device type ID	0x103C
Baud rates	Automatic ¹⁰ / ₁₀₀ Mbit with half-duplex and full-duplex detection
Polarity	Auto-polarity for automatic correction of crossed Tx/D and Rx/D pairs
Supported CIP connections	Max. 3 connections
Explicit connections	Max. 6 connections
I/O connections	Max. 6 connections (scanner)
Configuration options for measuring device	<ul style="list-style-type: none"> ▪ DIP switches on the electronics module for IP addressing ▪ Manufacturer-specific software (FieldCare) ▪ Add-on Profile Level 3 for Rockwell Automation control systems ▪ Web browser ▪ Electronic Data Sheet (EDS) integrated in the measuring device
Configuration of the EtherNet interface	<ul style="list-style-type: none"> ▪ Speed: 10 MBit, 100 MBit, auto (factory setting) ▪ Duplex: half-duplex, full-duplex, auto (factory setting)
Configuration of the device address	<ul style="list-style-type: none"> ▪ DIP switches on the electronics module for IP addressing (last octet) ▪ DHCP ▪ Manufacturer-specific software (FieldCare) ▪ Add-on Profile Level 3 for Rockwell Automation control systems ▪ Web browser ▪ EtherNet/IP tools, e.g. RSLinx (Rockwell Automation)

Device Level Ring (DLR)	Yes
System integration	Information regarding system integration: Operating Instructions →  123. <ul style="list-style-type: none"> ▪ Cyclic data transmission ▪ Block model ▪ Input and output groups

PROFINET

Protocol	Application layer protocol for decentral device periphery and distributed automation, Version 2.3
Communication type	100 MBit/s
Conformance Class	Conformance Class B
Netload Class	Netload Class 2 0 Mbps
Baud rates	Automatic 100 Mbit/s with full-duplex detection
Cycle times	From 8 ms
Polarity	Auto-polarity for automatic correction of crossed TxD and RxD pairs
Media Redundancy Protocol (MRP)	Yes
System redundancy support	System redundancy S2 (2 AR with 1 NAP)
Device profile	Application interface identifier 0xF600 Generic device
Manufacturer ID	0x11
Device type ID	0x843C
Device description files (GSD, DTM, DD)	Information and files under: <ul style="list-style-type: none"> ▪ www.endress.com On the product page for the device: Documents/Software → Device drivers ▪ www.profibus.com
Supported connections	<ul style="list-style-type: none"> ▪ 2 x AR (IO Controller AR) ▪ 1 x AR (IO-Supervisor Device AR connection allowed) ▪ 1 x Input CR (Communication Relation) ▪ 1 x Output CR (Communication Relation) ▪ 1 x Alarm CR (Communication Relation)
Configuration options for measuring device	<ul style="list-style-type: none"> ▪ DIP switches on the electronics module, for device name assignment (last part) ▪ Asset management software (FieldCare, DeviceCare, Field Xpert) ▪ Integrated Web server via Web browser and IP address ▪ Device master file (GSD), can be read out via the integrated Web server of the measuring device. ▪ Onsite operation
Configuration of the device name	<ul style="list-style-type: none"> ▪ DIP switches on the electronics module, for device name assignment (last part) ▪ DCP protocol ▪ Asset management software (FieldCare, DeviceCare, Field Xpert) ▪ Integrated Web server

Supported functions	<ul style="list-style-type: none"> ▪ Identification & Maintenance, simple device identifier via: <ul style="list-style-type: none"> ▪ Control system ▪ Nameplate ▪ Measured value status The process variables are communicated with a measured value status ▪ Blinking feature via the local display for simple device identification and assignment ▪ Device operation via asset management software (e.g. FieldCare, DeviceCare, SIMATIC PDM)
System integration	<p>Information regarding system integration: Operating Instructions →  123.</p> <ul style="list-style-type: none"> ▪ Cyclic data transmission ▪ Overview and description of the modules ▪ Status coding ▪ Startup configuration ▪ Factory setting

PROFINET with Ethernet-APL

Protocol	Application layer protocol for decentral device periphery and distributed automation, Version 2.4
Communication type	Ethernet Advanced Physical Layer 10BASE-T1L
Conformance Class	Conformance Class B (PA)
Netload Class	Netload Class 2 0 Mbps
Baud rates	10 Mbit/s Full-duplex
Cycle times	64 ms
Polarity	Automatic correction of crossed "APL signal +" and "APL signal -" signal lines
Media Redundancy Protocol (MRP)	Not possible (point-to-point connection to APL field switch)
System redundancy support	System redundancy S2 (2 AR with 1 NAP)
Device profile	PROFINET PA profile 4 (Application interface identifier API: 0x9700)
Manufacturer ID	0x11
Device type ID	0xA43C
Device description files (GSD, DTM, FDI)	<p>Information and files under:</p> <ul style="list-style-type: none"> ▪ www.endress.com/download On the device product page: PRODUCTS → Product Finder → Links ▪ www.profibus.com
Supported connections	<ul style="list-style-type: none"> ▪ 2x AR (IO Controller AR) ▪ 2x AR (IO Supervisor Device AR connection allowed)
Configuration options for measuring device	<ul style="list-style-type: none"> ▪ DIP switches on the electronics module, for device name assignment (last part) ▪ Asset management software (FieldCare, DeviceCare, Field Xpert) ▪ Integrated Web server via Web browser and IP address ▪ Device master file (GSD), can be read out via the integrated Web server of the measuring device. ▪ Onsite operation
Configuration of the device name	<ul style="list-style-type: none"> ▪ DIP switches on the electronics module, for device name assignment (last part) ▪ DCP protocol ▪ Asset management software (FieldCare, DeviceCare, Field Xpert) ▪ Integrated Web server

Supported functions	<ul style="list-style-type: none"> ▪ Identification & Maintenance, simple device identifier via: <ul style="list-style-type: none"> ▪ Control system ▪ Nameplate ▪ Measured value status The process variables are communicated with a measured value status ▪ Blinking feature via the local display for simple device identification and assignment ▪ Device operation via asset management software (e.g. FieldCare, DeviceCare, SIMATIC PDM with FDI package)
System integration	<p>Information regarding system integration: Operating Instructions →  123.</p> <ul style="list-style-type: none"> ▪ Cyclic data transmission ▪ Overview and description of the modules ▪ Status coding ▪ Startup configuration ▪ Factory setting

Power supply

Terminal assignment

Transmitter: supply voltage, input/outputs

HART

Supply voltage		Input/output 1		Input/output 2		Input/output 3		Input/output 4	
1 (+)	2 (-)	26 (+)	27 (-)	24 (+)	25 (-)	22 (+)	23 (-)	20 (+)	21 (-)
The terminal assignment depends on the specific device version ordered →  14.									

FOUNDATION Fieldbus

Supply voltage		Input/output 1		Input/output 2		Input/output 3		Input/output 4	
1 (+)	2 (-)	26 (A)	27 (B)	24 (+)	25 (-)	22 (+)	23 (-)	20 (+)	21 (-)
The terminal assignment depends on the specific device version ordered →  14.									

PROFIBUS DP

Supply voltage		Input/output 1		Input/output 2		Input/output 3		Input/output 4	
1 (+)	2 (-)	26 (B)	27 (A)	24 (+)	25 (-)	22 (+)	23 (-)	20 (+)	21 (-)
The terminal assignment depends on the specific device version ordered →  14.									

PROFIBUS PA

Supply voltage		Input/output 1		Input/output 2		Input/output 3		Input/output 4	
1 (+)	2 (-)	26 (B)	27 (A)	24 (+)	25 (-)	22 (+)	23 (-)	20 (+)	21 (-)
The terminal assignment depends on the specific device version ordered →  14.									

Modbus RS485

Supply voltage		Input/output 1		Input/output 2		Input/output 3		Input/output 4	
1 (+)	2 (-)	26 (B)	27 (A)	24 (+)	25 (-)	22 (+)	23 (-)	20 (+)	21 (-)
The terminal assignment depends on the specific device version ordered →  14.									

EtherNet/IP

Supply voltage		Input/output 1	Input/output 2	Input/output 3	Input/output 4
1 (+)	2 (-)	EtherNet/IP (RJ45 connector)	24 (+) 25 (-)	22 (+) 23 (-)	20 (+) 21 (-)
The terminal assignment depends on the specific device version ordered →  14.					

PROFINET

Supply voltage		Input/output 1	Input/output 2	Input/output 3	Input/output 4
1 (+)	2 (-)	PROFINET (RJ45 connector)	24 (+) 25 (-)	22 (+) 23 (-)	20 (+) 21 (-)
The terminal assignment depends on the specific device version ordered →  14.					



PROFINET with Ethernet-APL

Supply voltage		Input/output 1	Input/output 2	Input/output 3	Input/output 4
1 (+)	2 (-)	EtherNet/IP (RJ45 connector)	24 (+) 25 (-)	22 (+) 23 (-)	20 (+) 21 (-)
The terminal assignment depends on the specific device version ordered →  14.					

Transmitter and sensor connection housing: connecting cable

The sensor and transmitter, which are mounted in separate locations, are interconnected by a connecting cable. The cable is connected via the sensor connection housing and the transmitter housing.

Terminal assignment and connection of the connecting cable:





- Proline 500 – digital →  37
- Proline 500 →  37

Available device plugs

 Device plugs may not be used in hazardous areas!

Device plugs for fieldbus systems:

Order code for "Input; output 1"

- Option **SA** "FOUNDATION Fieldbus" →  33
- Option **GA** "PROFIBUS PA" →  34
- Option **NA** "EtherNet/IP" →  34
- Option **RA** "PROFINET" →  34
- Option **RB** "PROFINET with Ethernet-APL" →  34

Device plug for connecting to the service interface:

Order code for "Accessory mounted"

Option **NB**, adapter RJ45 M12 (service interface) →  36

Order code for "Input; output 1", option SA "FOUNDATION Fieldbus"

Order code for "Electrical connection"	Cable entry/connection →  37	
	2	3
M, 3, 4, 5	7/8" connector	-

Order code for "Input; output 1", option GA "PROFIBUS PA"

Order code for "Electrical connection"	Cable entry/connection → 37	
	2	3
L, N, P, U	Connector M12 × 1	-

Order code for "Input; output 1", option NA "EtherNet/IP"

Order code for "Electrical connection"	Cable entry/connection → 37	
	2	3
L, N, P, U	Connector M12 × 1	-
R ^{1) 2)} , S ^{1) 2)} , T ^{1) 2)} , V ^{1) 2)}	Connector M12 × 1	Connector M12 × 1

- 1) Cannot be combined with an external WLAN antenna (order code for "Enclosed accessories", option P8) of an RJ45 M12 adapter for the service interface (order code for "Accessories mounted", option NB) or of the remote display and operating module DKX001
- 2) Suitable for integrating the device in a ring topology.

Order code for "Input; output 1", option RA "PROFINET"

Order code for "Electrical connection"	Cable entry/connection → 37	
	2	3
L, N, P, U	Connector M12 × 1	-
R ^{1) 2)} , S ^{1) 2)} , T ^{1) 2)} , V ^{1) 2)}	Connector M12 × 1	Connector M12 × 1

- 1) Cannot be combined with an external WLAN antenna (order code for "Enclosed accessories", option P8) of an RJ45 M12 adapter for the service interface (order code for "Accessories mounted", option NB) or of the remote display and operating module DKX001.
- 2) Suitable for integrating the device in a ring topology.

Order code for "Input; output 1", option RB "PROFINET with Ethernet-APL"

Order code "Electrical connection"	Cable entry/connection → 37	
	2	3
L, N, P, U	M12 plug × 1	-

Order code for "Accessory mounted", option NB "Adapter RJ45 M12 (service interface)"

Order code "Accessory mounted"	Cable entry/coupling → 37	
	Cable entry 2	Cable entry 3
NB	Plug M12 × 1	-

Pin assignment, device plug**FOUNDATION Fieldbus**

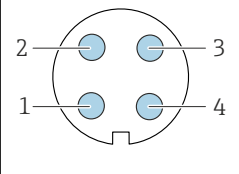
	Pin	Assignment	Coding	Plug/socket
	1	+	Signal +	A
2	-	Signal -		
3		Grounding		
4		Not assigned		

PROFIBUS PA

	Pin	Assignment		Coding	Plug/socket
	1	+	PROFIBUS PA +	A	Plug
	2		Grounding		
	3	-	PROFIBUS PA -		
	4		Not assigned		

- i** Recommended plug:
- Binder, series 713, part no. 99 1430 814 04
 - Phoenix, part no. 1413934 SACC-FS-4QO SH PBPA SCO

PROFINET

	Pin	Assignment		Coding	Plug/socket
	1	+	TD +	D	Socket
	2	+	RD +		
	3	-	TD -		
	4	-	RD -		
	Coding		Plug/socket		
D		Socket			

- i** Recommended plug:
- Binder, series 825, part no. 99 3729 810 04
 - Phoenix, part no. 1543223 SACC-M12MSD-4Q

PROFINET with Ethernet-APL

	Pin	Assignment		Coding	Plug/socket
	1	-	APL signal -	A	Socket
	2	+	APL signal +		
	3		Cable shield ¹		
	4		Not assigned		
	Metal plug housing		Cable shield		
¹ If a cable shield is used					

- i** Recommended plug:
- Binder, series 713, part no. 99 1430 814 04
 - Phoenix, part no. 1413934 SACC-FS-4QO SH PBPA SCO

EtherNet/IP

	Pin	Assignment		Coding	Plug/socket
	1	+	Tx	D	Socket
	2	+	Rx		
	3	-	Tx		
	4	-	Rx		
	Coding		Plug/socket		
D		Socket			

- i** Recommended plug:
- Binder, series 763, part no. 99 3729 810 04
 - Phoenix, part no. 1543223 SACC-M12MSD-4Q

Service interface

Order code for "Accessories mounted", option **NB**: Adapter RJ45 M12 (service interface)

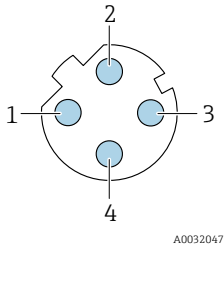
	Pin	Assignment	
	1	+	Tx
	2	+	Rx
	3	-	Tx
	4	-	Rx
Coding	Plug/socket		
D	Socket		

- i** Recommended plug:
- Binder, series 763, part no. 99 3729 810 04
 - Phoenix, part no. 1543223 SACC-M12MSD-4Q

Supply voltage	Order code for "Power supply"	Terminal voltage		Frequency range
	Option D	DC 24 V	±20%	–
Option E	AC 100 to 240 V	–15 to +10%	50/60 Hz, ±4 Hz	
Option I	DC 24 V	±20%	–	
	AC 100 to 240 V	–15 to +10%	50/60 Hz, ±4 Hz	

Power consumption

Transmitter

Max. 10 W (active power)

switch-on current	Max. 36 A (<5 ms) as per NAMUR Recommendation NE 21
--------------------------	-----------------------------------------------------

Current consumption

Transmitter

- Max. 400 mA (24 V)
- Max. 200 mA (110 V, 50/60 Hz; 230 V, 50/60 Hz)

Power supply failure

- Totalizers stop at the last value measured.
- Depending on the device version, the configuration is retained in the device memory or in the pluggable data memory (HistoROM DAT).
- Error messages (incl. total operated hours) are stored.

Overcurrent protection element

The device must be operated with a dedicated circuit breaker, as it does not have an ON/OFF switch of its own.

- The circuit breaker must be easy to reach and labeled accordingly.
- Permitted nominal current of the circuit breaker: 2 A up to maximum 10 A.

Electrical connection

Connection of connecting cable: Proline 500 – digital

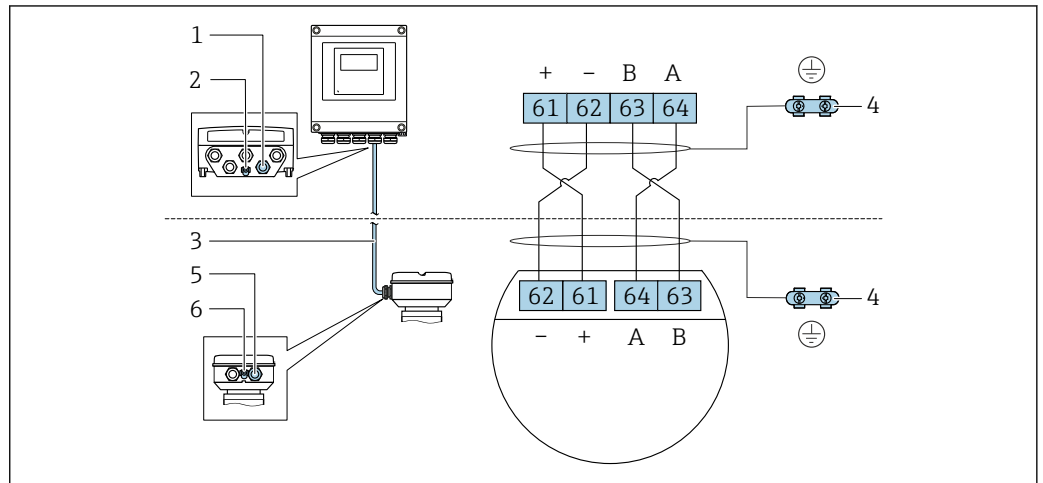

A0028198

- 1 Cable entry for cable on transmitter housing
- 2 Terminal connection for potential equalization (PE)
- 3 Connecting cable ISEM communication
- 4 Grounding via ground connection; in the version with a device plug, grounding is ensured through the plug itself
- 5 Cable entry for cable or connection of device plug on sensor connection housing
- 6 Terminal connection for potential equalization (PE)

Connection of the connecting cable: Proline 500

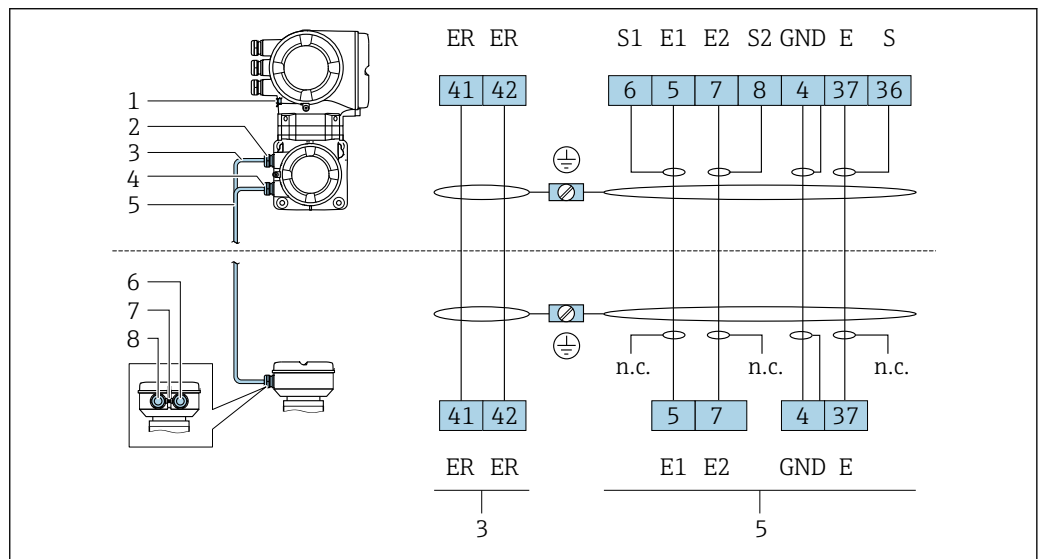

A0029145

- 1 Terminal connection for potential equalization (PE)
- 2 Cable entry for coil current cable on transmitter connection housing
- 3 Coil current cable
- 4 Cable entry for signal cable on transmitter connection housing
- 5 Signal cable
- 6 Cable entry for signal cable on sensor connection housing
- 7 Terminal connection for potential equalization (PE)
- 8 Cable entry for coil current cable on sensor connection housing

Transmitter connection

- Terminal assignment → 32
- Device plug pin assignment → 34

Transmitter connection: Proline 500 – digital

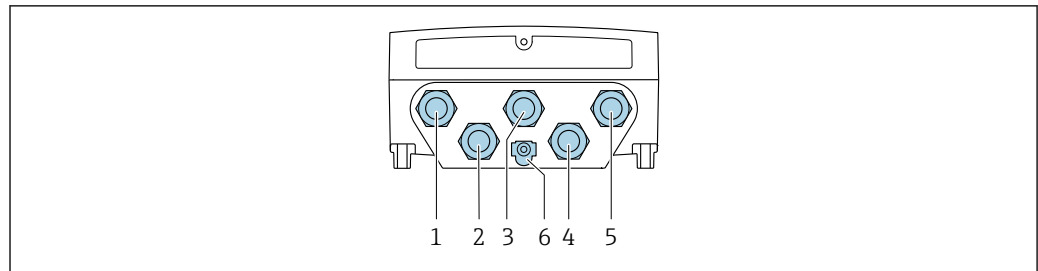

A0028200

- 1 Terminal connection for supply voltage
- 2 Terminal connection for signal transmission, input/output
- 3 Terminal connection for signal transmission, input/output
- 4 Terminal connection for connecting cable between sensor and transmitter
- 5 Terminal connection for signal transmission, input/output or terminal for network connection (DHCP client) via service interface (CDI-RJ45); optional: terminal connection for external WLAN antenna
- 6 Terminal connection for potential equalization (PE)

i An adapter for RJ45 to the M12 plug is optionally available:
Order code for "Accessories", option **NB**: "Adapter RJ45 M12 (service interface)"

The adapter connects the service interface (CDI-RJ45) to an M12 plug mounted in the cable entry. Therefore the connection to the service interface can be established via an M12 plug without opening the device.

i Network connection (DHCP client) via service interface (CDI-RJ45) → 107

Connecting the transmitter: Proline 500

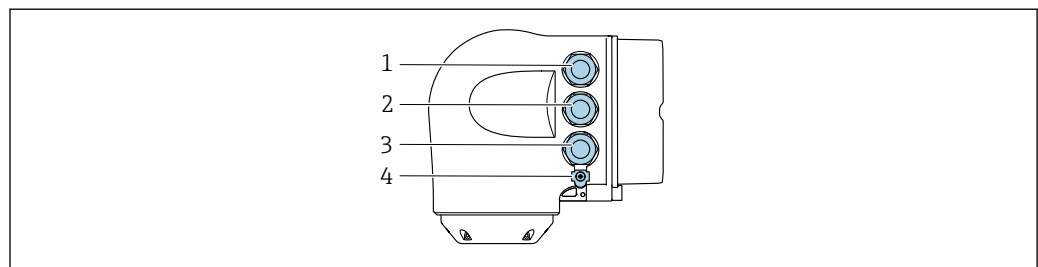

A0026781

- 1 Terminal connection for supply voltage
- 2 Terminal connection for signal transmission, input/output
- 3 Terminal connection for signal transmission, input/output or terminal for network connection (DHCP client) via service interface (CDI-RJ45); optional: terminal connection for external WLAN antenna
- 4 Terminal connection for potential equalization (PE)

i An adapter for RJ45 to the M12 plug is optionally available:
Order code for "Accessories", option **NB**: "Adapter RJ45 M12 (service interface)"

The adapter connects the service interface (CDI-RJ45) to an M12 plug mounted in the cable entry. Therefore the connection to the service interface can be established via an M12 plug without opening the device.

i Network connection (DHCP client) via service interface (CDI-RJ45) → 107

Connecting in a ring topology

Device versions with EtherNet/IP and PROFINET communication protocols can be integrated into a ring topology. The device is integrated via the terminal connection for signal transmission (output 1) and the connection to the service interface (CDI-RJ45).

- i** Transmitters with an Ex de approval may **not** be connected via the service interface (CDI-RJ45)!
Order code for "Approval transmitter + sensor", options (Ex de):
BB, C2, GB, MB, NB
- i** Integrate the transmitter in a ring topology:
 - EtherNet/IP
 - PROFINET

Transmitter: Proline 500 – digital

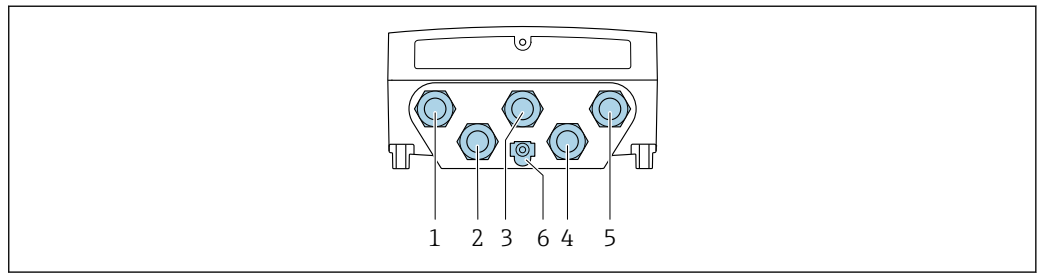

A0028200

- 1 Terminal connection for supply voltage
- 2 Terminal connection for signal transmission, input/output
- 2 Terminal connection for signal transmission: PROFINET or EtherNet/IP (RJ45 plug)
- 4 Terminal connection for connecting cable between sensor and transmitter
- 5 Terminal connection to service interface (CDI-RJ45)
- 6 Terminal connection for potential equalization (PE)

Transmitter: Proline 500

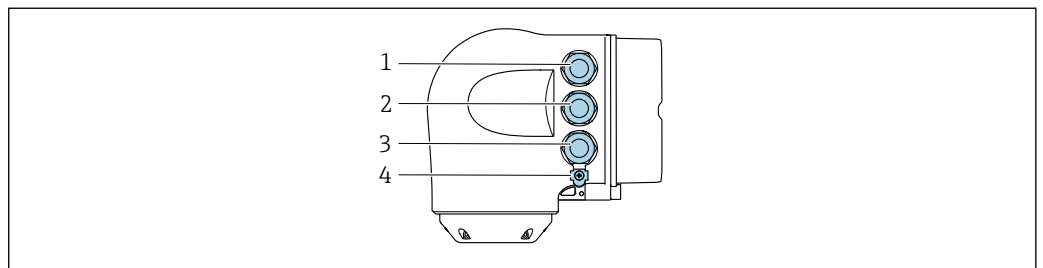

A0026781

- 1 Terminal connection for supply voltage
- 2 Terminal connection for signal transmission: PROFINET or EtherNet/IP (RJ45 plug)
- 3 Terminal connection to service interface (CDI-RJ45)
- 4 Terminal connection for potential equalization (PE)

- i** If the device has additional inputs/outputs, these are routed in parallel via the cable entry for connection to the service interface.

Connection examples

Current output 4 to 20 mA HART

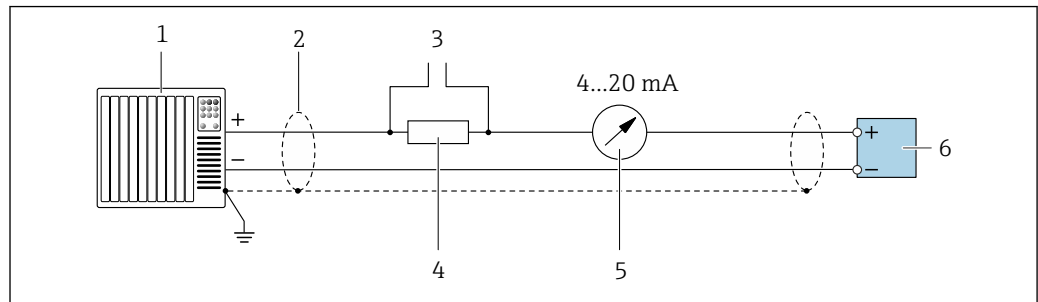

A0029055

2 Connection example for 4 to 20 mA HART current output (active)

- 1 Automation system with current input (e.g. PLC)
- 2 Cable shield provided at one end. The cable shield must be grounded at both ends to comply with EMC requirements; observe cable specifications → 52
- 3 Connection for HART operating devices → 101
- 4 Resistor for HART communication ($\geq 250 \Omega$); observe maximum load → 16
- 5 Analog display unit: observe maximum load → 16
- 6 Transmitter

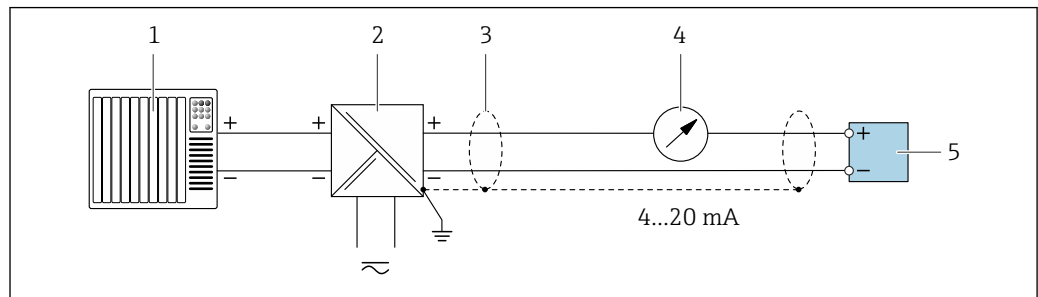

A0028762

3 Connection example for 4 to 20 mA HART current output (passive)

- 1 Automation system with current input (e.g. PLC)
- 2 Power supply
- 3 Cable shield provided at one end. The cable shield must be grounded at both ends to comply with EMC requirements; observe cable specifications → 52
- 4 Analog display unit: observe maximum load → 16
- 5 Transmitter

HART input

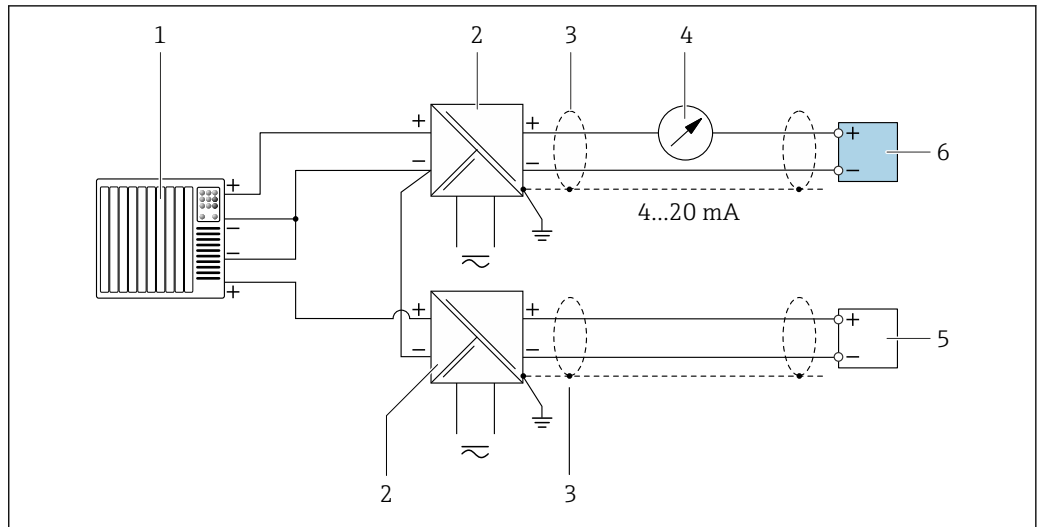

A0028763

4 Connection example for HART input with a common negative (passive)

- 1 Automation system with HART output (e.g. PLC)
- 2 Active barrier for power supply (e.g. RN221N)
- 3 Cable shield provided at one end. The cable shield must be grounded at both ends to comply with EMC requirements; observe cable specifications
- 4 Analog display unit: observe maximum load → 16
- 5 Pressure transmitter (e.g. Cerabar M, Cerabar S): see requirements
- 6 Transmitter

PROFIBUS PA

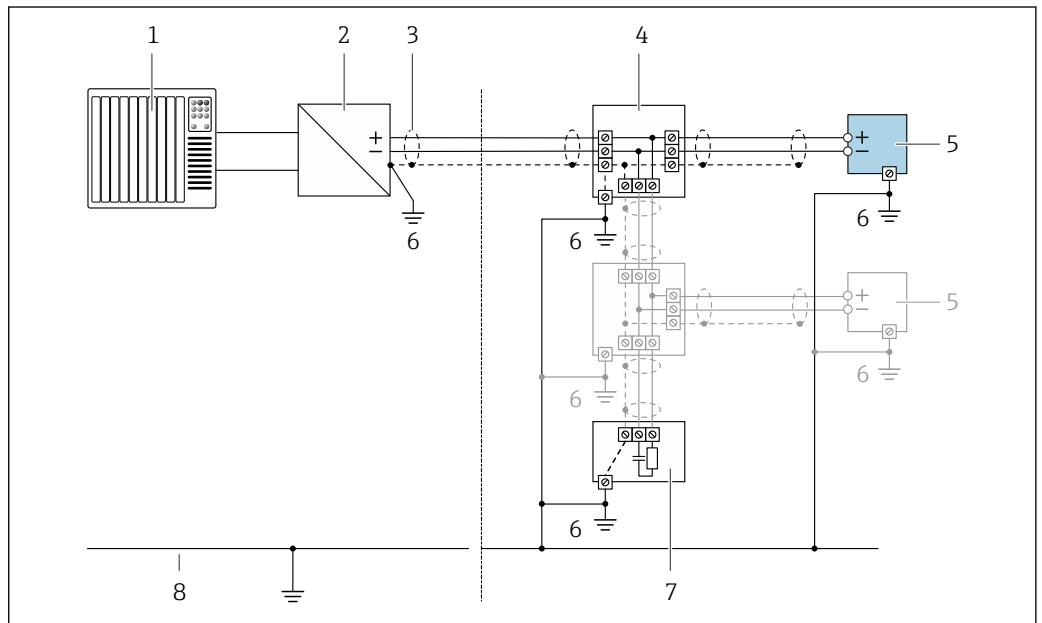

A0028768

5 Connection example for PROFIBUS PA

- 1 Control system (e.g. PLC)
- 2 PROFIBUS PA segment coupler
- 3 Cable shield provided at one end. The cable shield must be grounded at both ends to comply with EMC requirements; observe cable specifications
- 4 T-box
- 5 Measuring device
- 6 Local grounding
- 7 Bus terminator
- 8 Potential matching line

PROFIBUS DP

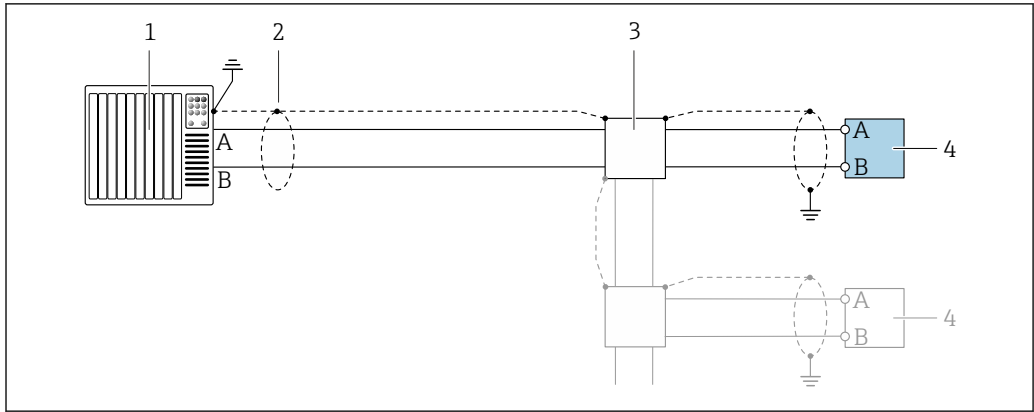

A0028765

6 Connection example for PROFIBUS DP, non-hazardous area and Zone 2/Div. 2

- 1 Control system (e.g. PLC)
- 2 Cable shield provided at one end. The cable shield must be grounded at both ends to comply with EMC requirements; observe cable specifications
- 3 Distribution box
- 4 Transmitter

i If baud rates > 1.5 Mbaud an EMC cable entry must be used and the cable shield must continue as far as the terminal wherever possible.

EtherNet/IP

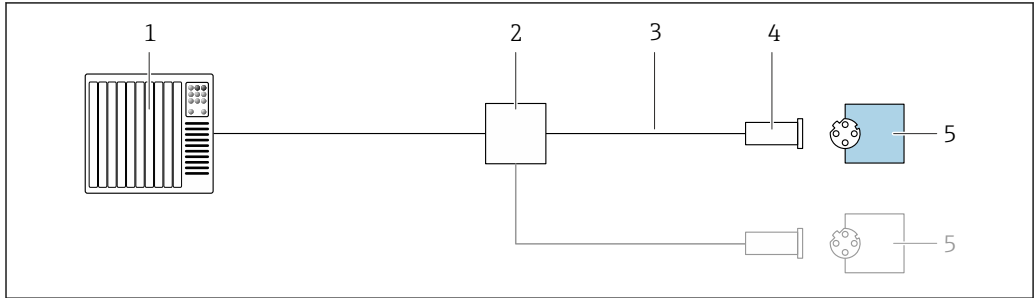

A0028767

7 Connection example for EtherNet/IP

- 1 Control system (e.g. PLC)
- 2 Ethernet switch
- 3 Observe cable specifications
- 4 Device plug
- 5 Transmitter

EtherNet/IP: DLR (Device Level Ring)

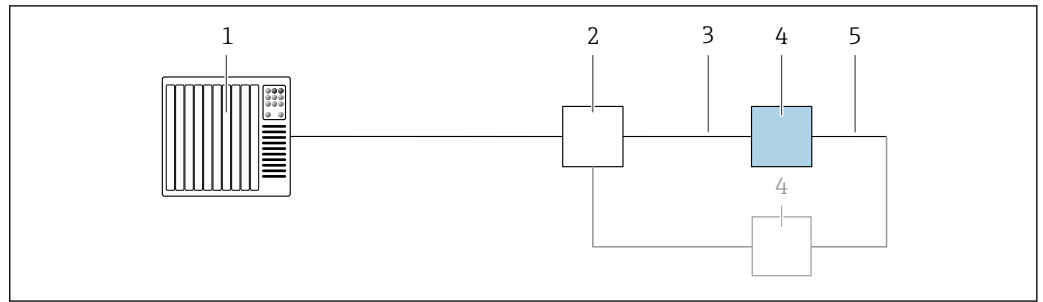

A0027544

- 1 Control system (e.g. PLC)
- 2 Ethernet switch
- 3 Observe cable specifications → 53
- 4 Transmitter
- 5 Connecting cable between the two transmitters

PROFINET

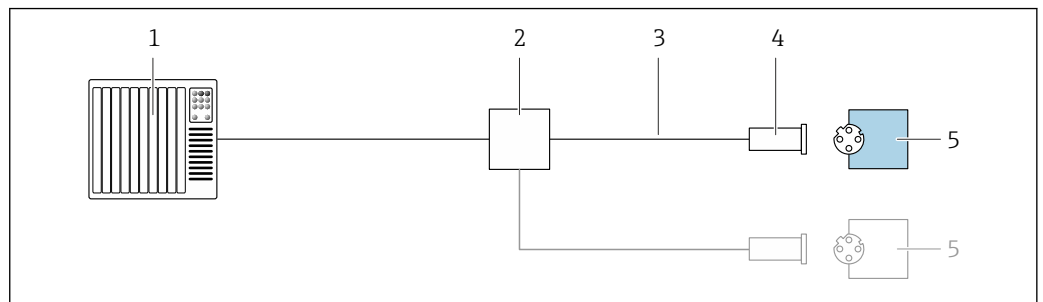

A0028767

8 Connection example for PROFINET

- 1 Control system (e.g. PLC)
- 2 Ethernet switch
- 3 Observe cable specifications
- 4 Device plug
- 5 Transmitter

PROFINET with Ethernet-APL

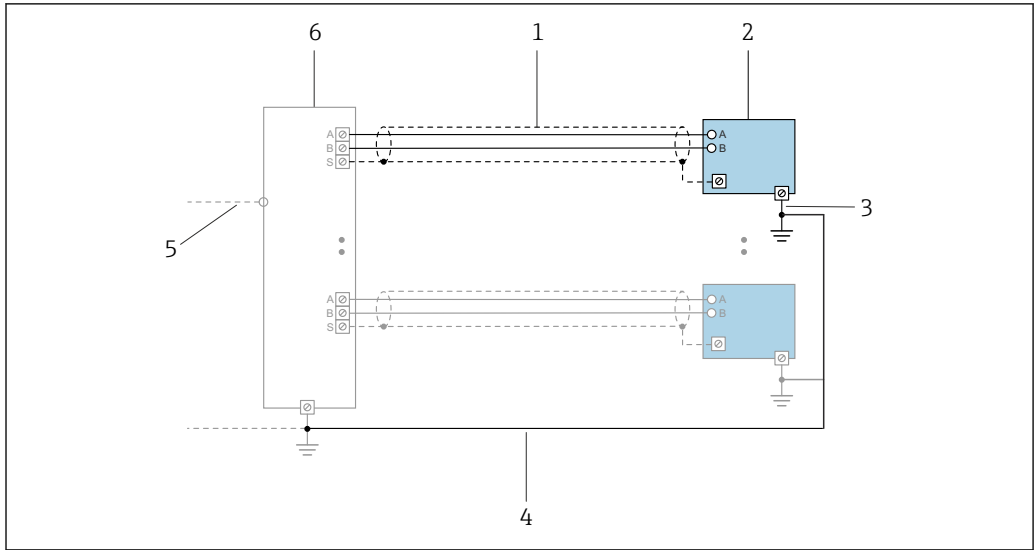

A0047536

9 Connection example for PROFINET with Ethernet-APL

- 1 Cable shield
- 2 Measuring device
- 3 Local grounding
- 4 Potential equalization
- 5 Trunk or TCP
- 6 Field switch

PROFINET: MRP (Media Redundancy Protocol)

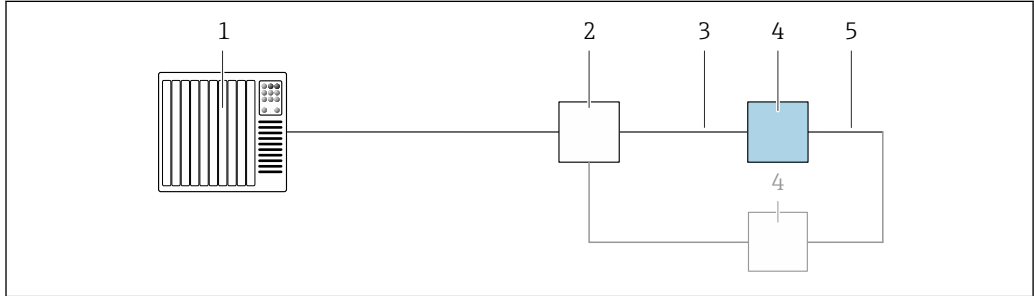

A0027544

- 1 Control system (e.g. PLC)
- 2 Ethernet switch
- 3 Observe cable specifications → 53
- 4 Transmitter
- 5 Connecting cable between the two transmitters

PROFINET: system redundancy S2

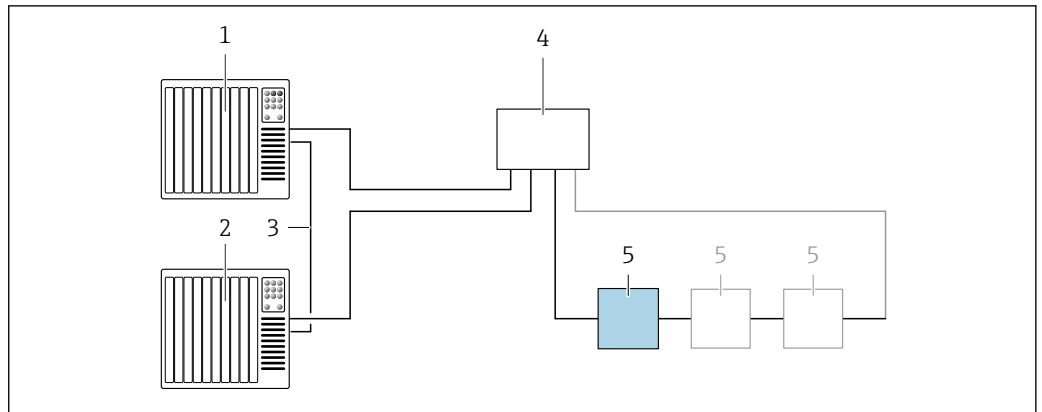

A0039553

10 Connection example for system redundancy S2

- 1 Control system 1 (e.g. PLC)
- 2 Synchronization of control systems
- 3 Control system 2 (e.g. PLC)
- 4 Industrial Ethernet Managed Switch
- 5 Transmitter

FOUNDATION Fieldbus

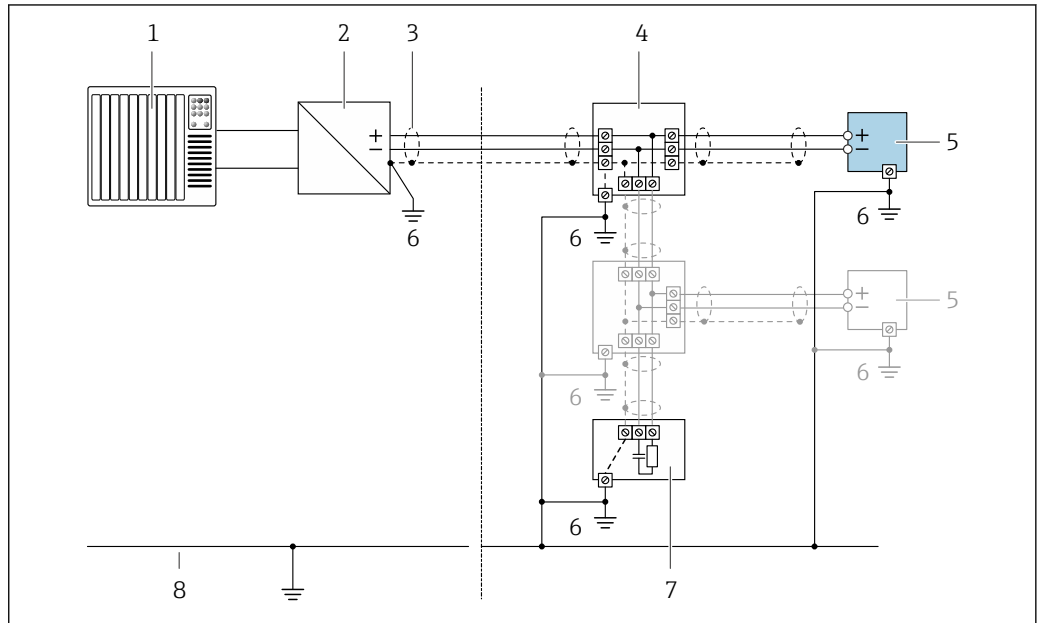

A0028768

11 Connection example for FOUNDATION Fieldbus

- 1 Control system (e.g. PLC)
- 2 Power Conditioner (FOUNDATION Fieldbus)
- 3 Cable shield provided at one end. The cable shield must be grounded at both ends to comply with EMC requirements; observe cable specifications
- 4 T-box
- 5 Measuring device
- 6 Local grounding
- 7 Bus terminator
- 8 Potential matching line

Modbus RS485

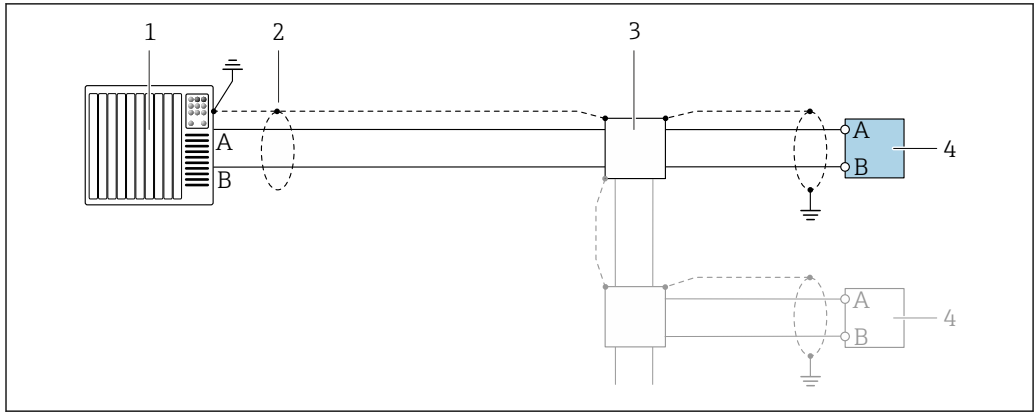

A0028765

12 Connection example for Modbus RS485, non-hazardous area and Zone 2/Div. 2

- 1 Control system (e.g. PLC)
- 2 Cable shield provided at one end. The cable shield must be grounded at both ends to comply with EMC requirements; observe cable specifications
- 3 Distribution box
- 4 Transmitter

Current output 4-20 mA

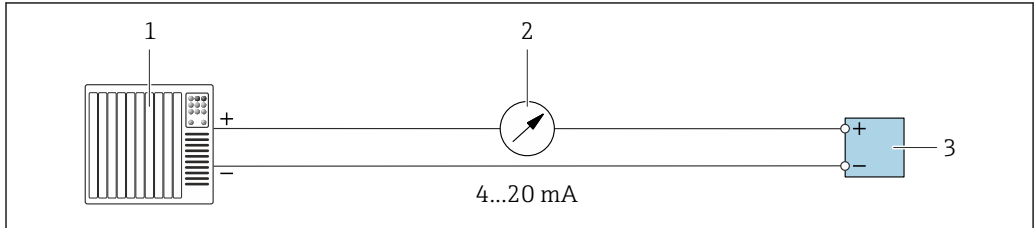

A0028758

13 Connection example for 4-20 mA current output (active)

- 1 Automation system with current input (e.g. PLC)
- 2 Analog display unit: observe maximum load → 16
- 3 Transmitter

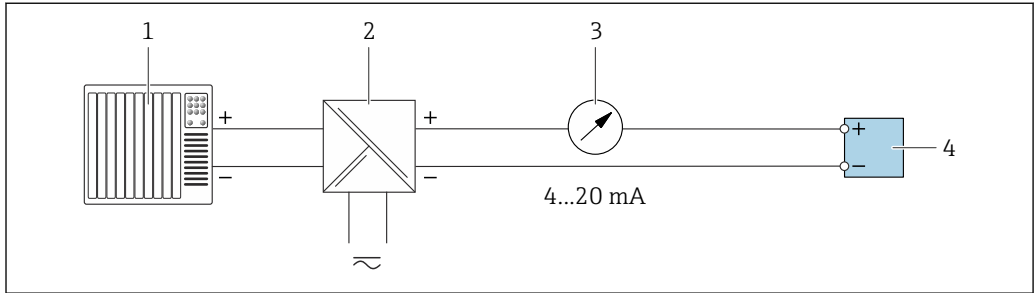

A0028759

14 Connection example for 4-20 mA current output (passive)

- 1 Automation system with current input (e.g. PLC)
- 2 Active barrier for power supply (e.g. RN221N)
- 3 Analog display unit: observe maximum load → 16
- 4 Transmitter

Pulse/frequency output

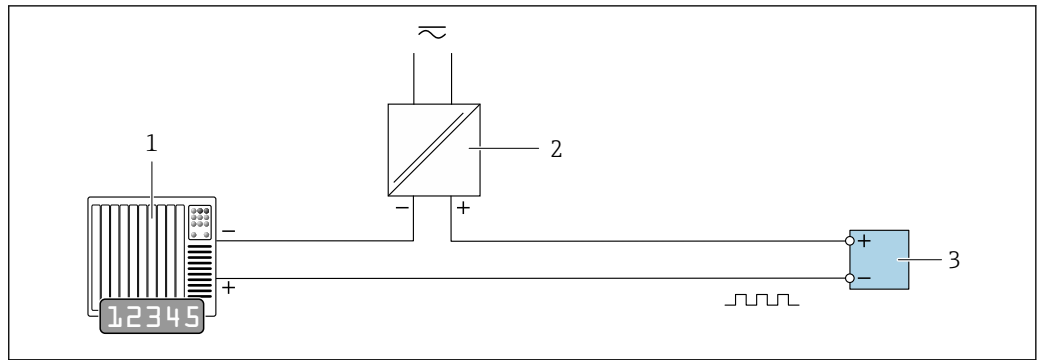

A0028761

15 Connection example for pulse/frequency output (passive)

- 1 Automation system with pulse/frequency input (e.g. PLC with 10 kΩ pull-up or pull-down resistor)
- 2 Power supply
- 3 Transmitter: observe input values → 19

Switch output

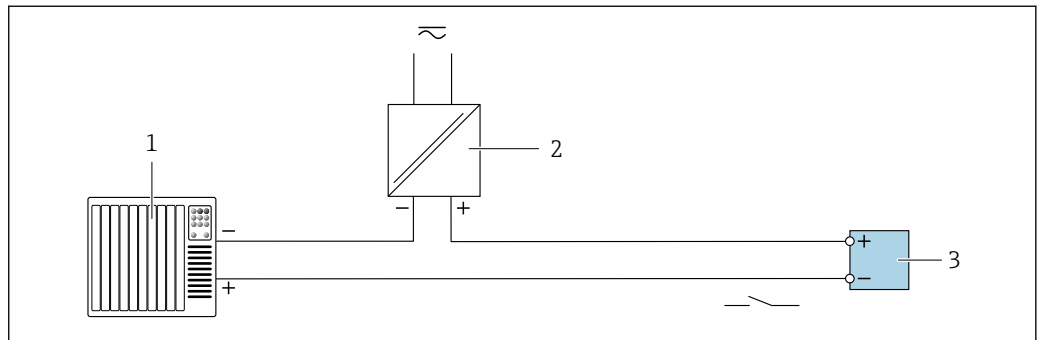

A0028760

16 Connection example for switch output (passive)

- 1 Automation system with switch input (e.g. PLC with a 10 kΩ pull-up or pull-down resistor)
- 2 Power supply
- 3 Transmitter: observe input values → 19

Double pulse output

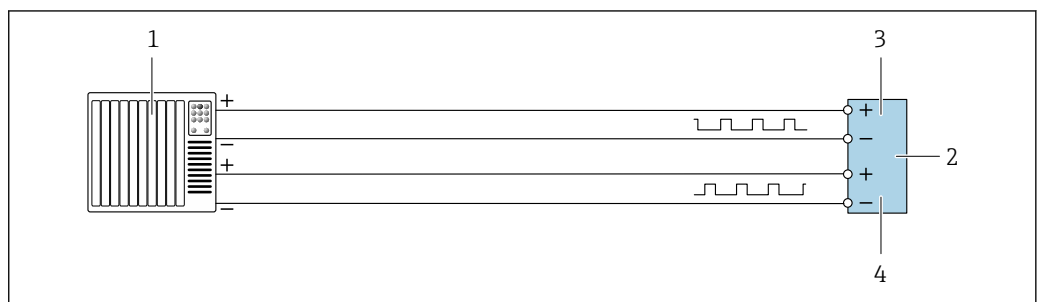

A0029280

17 Connection example for double pulse output (active)

- 1 Automation system with double pulse input (e.g. PLC)
- 2 Transmitter: observe input values → 20
- 3 Double pulse output
- 4 Double pulse output (slave), phase-shifted

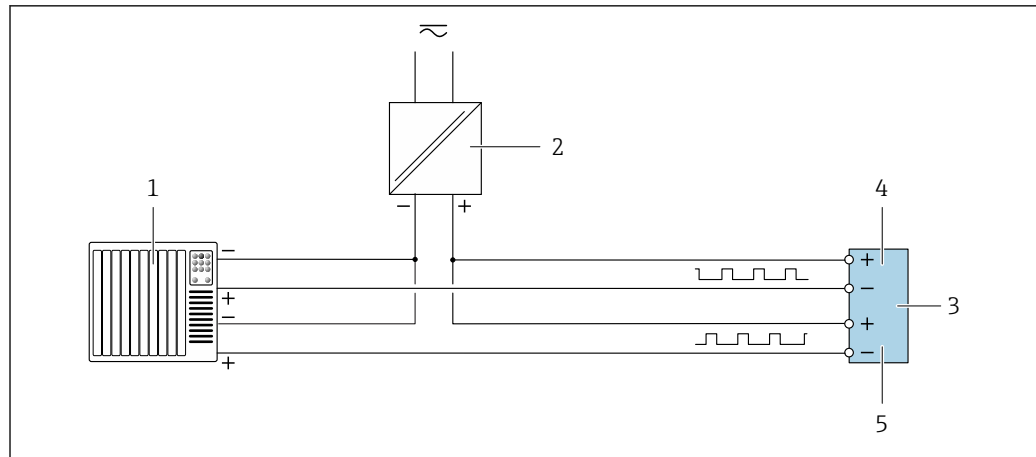

A0029279

18 Connection example for double pulse output (passive)

- 1 Automation system with double pulse input (e.g. PLC with a 10 k Ω pull-up or pull-down resistor)
- 2 Power supply
- 3 Transmitter: observe input values \rightarrow 20
- 4 Double pulse output
- 5 Double pulse output (slave), phase-shifted

Relay output

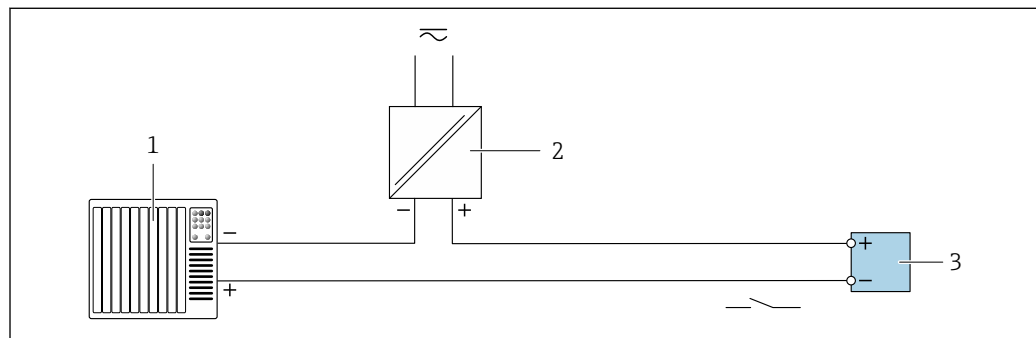

A0028760

19 Connection example for relay output (passive)

- 1 Automation system with relay input (e.g. PLC)
- 2 Power supply
- 3 Transmitter: observe input values \rightarrow 20

Current input

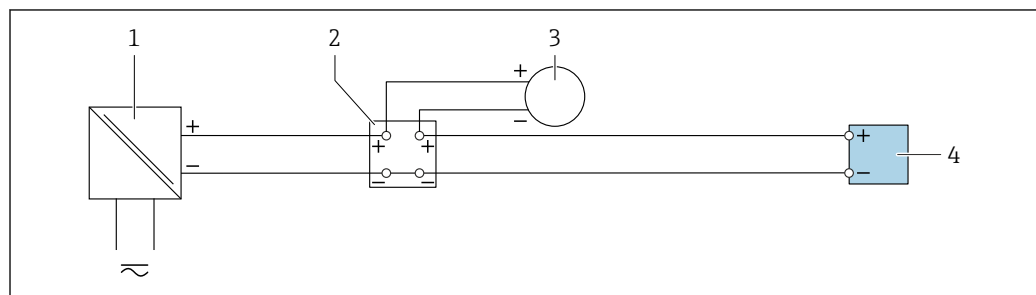

A0028915

20 Connection example for 4 to 20 mA current input

- 1 Power supply
- 2 Terminal box
- 3 External measuring device (to read in pressure or temperature, for instance)
- 4 Transmitter

Status input

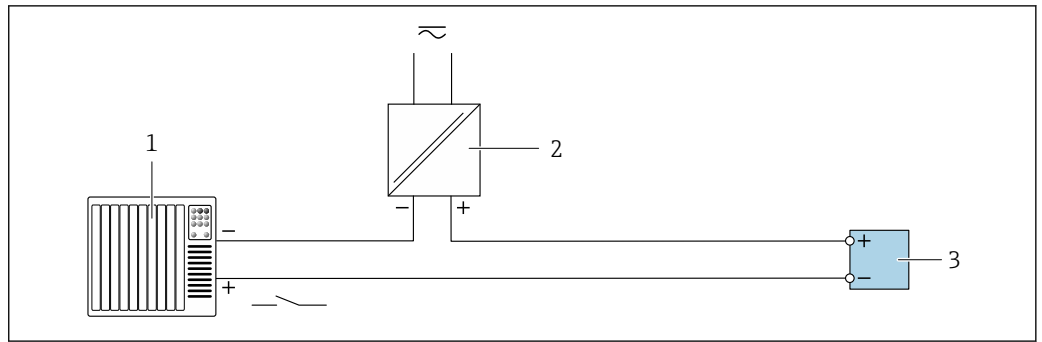

A0028764

21 Connection example for status input

- 1 Automation system with status output (e.g. PLC)
- 2 Power supply
- 3 Transmitter

Potential equalization

Introduction

Correct potential equalization (equipotential bonding) is a prerequisite for stable and reliable flow measurement. Inadequate or incorrect potential equalization can result in device failure and present a safety hazard.

The following requirements must be observed to ensure correct, trouble-free measurement:

- The principle that the medium, the sensor and the transmitter must be at the same electrical potential applies.
- Take in-company grounding guidelines, materials and the grounding conditions and potential conditions of the pipe into consideration.
- The necessary potential equalization connections must be established using a ground cable with a minimum cross-section of 6 mm² (0.0093 in²) and a cable lug.
- In the case of remote device versions, the ground terminal in the example always refers to the sensor and not to the transmitter.

You can order accessories such as ground cables and ground disks directly from Endress+Hauser → 120

For devices intended for use in hazardous areas, observe the instructions in the Ex documentation (XA).

Abbreviations used

- PE (Protective Earth): potential at the protective earth terminals of the device
- P_p (Potential Pipe): potential of the pipe, measured at the flanges
- P_M (Potential Medium): potential of the medium

Connection examples for standard situations

Unlined and grounded metal pipe

- Potential equalization is via the measuring pipe.
- The medium is set to ground potential.

Starting conditions:

- Pipes are correctly grounded on both sides.
- Pipes are conductive and at the same electrical potential as the medium

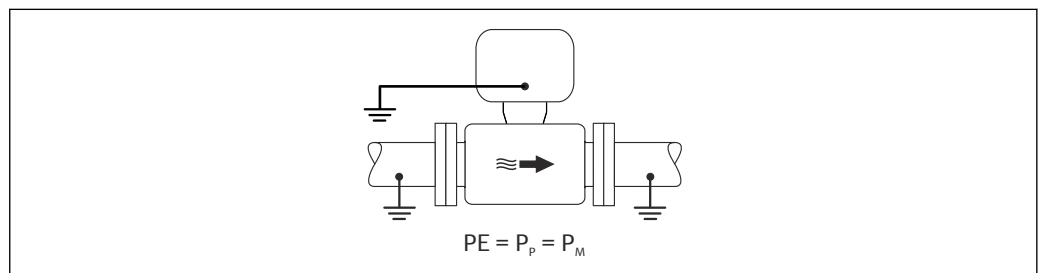

A0044854

- ▶ Connect the connection housing of the transmitter or sensor to ground potential by means of the ground terminal provided for this purpose.

Metal pipe without liner

- Potential equalization is via the ground terminal and pipe flanges.
- The medium is set to ground potential.

Starting conditions:

- Pipes are not sufficiently grounded.
- Pipes are conductive and at the same electrical potential as the medium

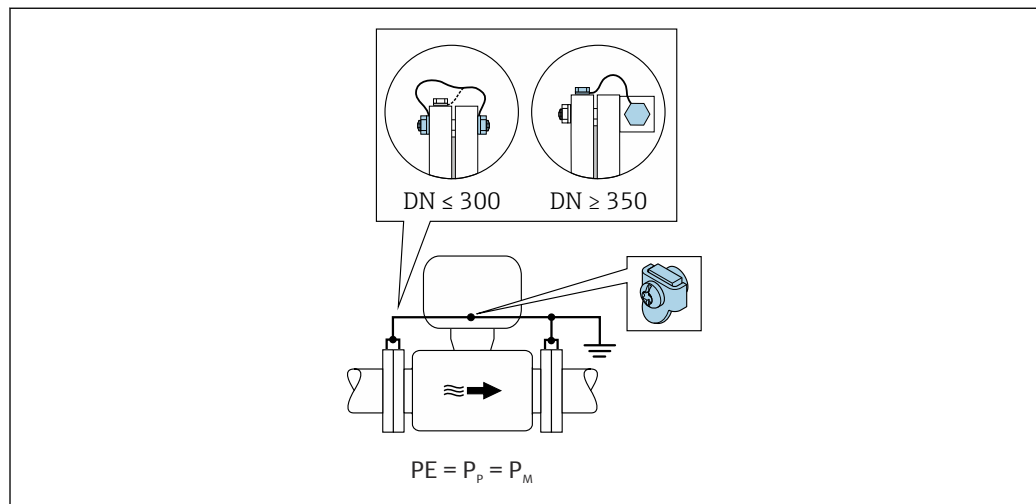

1. Connect both sensor flanges to the pipe flange via a ground cable and ground them.
2. Connect the connection housing of the transmitter or sensor to ground potential by means of the ground terminal provided for this purpose.
3. For DN ≤ 300 (12"): Mount the ground cable directly on the conductive flange coating of the sensor with the flange screws.
4. For DN ≥ 350 (14"): Mount the ground cable directly on the metal transport bracket. Observe the screw tightening torques: see the Brief Operating Instructions for the sensor.

Plastic pipe or pipe with insulating liner

The medium is set to ground potential.

Starting conditions:

- The pipe has an insulating effect.
- Low-impedance medium grounding close to the sensor is not guaranteed.
- Equalizing currents through the medium cannot be ruled out.

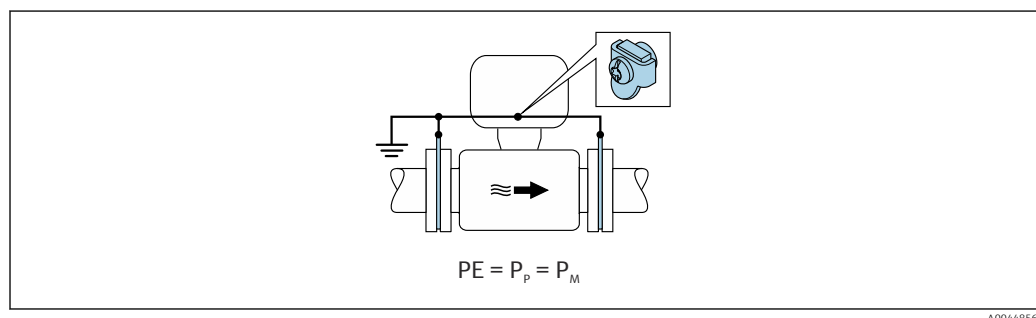

1. Connect the ground disks to the ground terminal of the transmitter or sensor connection housing via the ground cable.
2. Connect the connection to ground potential.

Connection example with the potential of medium not equal to protective ground without the "Floating measurement" option

In these cases, the medium potential can differ from the potential of the device.

Metal, ungrounded pipe

The sensor and transmitter are installed in a way that provides electrical insulation from PE, e.g. applications for electrolytic processes or systems with cathodic protection.

Starting conditions:

- Unlined metal pipe
- Pipes with an electrically conductive liner

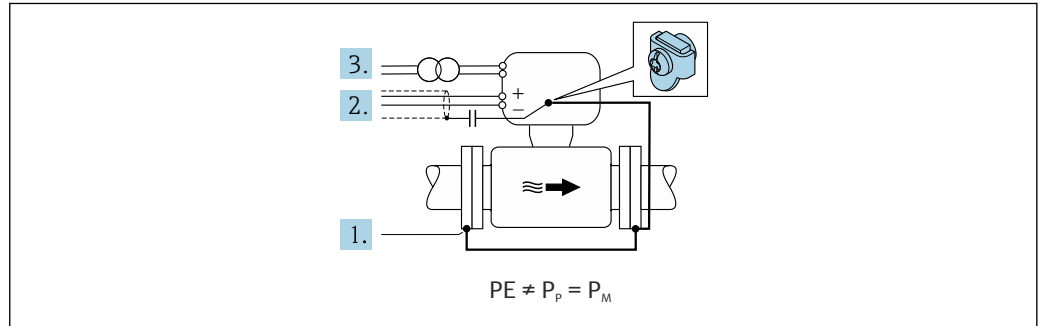

1. Connect the pipe flanges and transmitter via the ground cable.
2. Route the shielding of the signal lines via a capacitor (recommended value 1.5µF/50V).
3. Device connected to power supply such that it is floating in relation to the protective earth (isolation transformer). This measure is not required in the case of 24V DC supply voltage without PE (= SELV power unit).

Connection examples with the potential of medium not equal to protective ground with the "Floating measurement" option

In these cases, the medium potential can differ from the potential of the device.

Introduction

The "Floating measurement" option enables the galvanic isolation of the measuring system from the device potential. This minimizes harmful equalizing currents caused by differences in potential between the medium and the device. The "Floating measurement" option is optionally available: order code for "Sensor option", option CV

Operating conditions for the use of the "Floating measurement" option

Device version	Compact version and remote version (length of connecting cable ≤ 10 m)
Differences in voltage between medium potential and device potential	As small as possible, usually in the mV range
Alternating voltage frequencies in the medium or at ground potential (PE)	Below typical power line frequency in the country

i To achieve the specified conductivity measuring accuracy, a conductivity calibration is recommended when the device is installed.

A full pipe adjustment is recommended when the device is installed.

Plastic pipe

Sensor and transmitter are correctly grounded. A difference in potential can occur between the medium and protective earth. Potential equalization between P_M and PE via the reference electrode is minimized with the "Floating measurement" option.

Starting conditions:

- The pipe has an insulating effect.
- Equalizing currents through the medium cannot be ruled out.

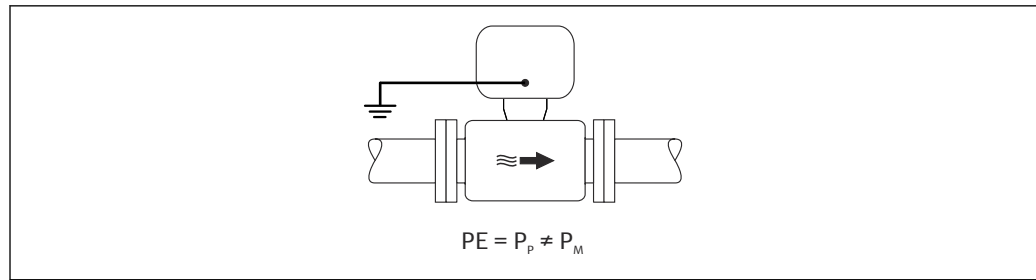

A0044855

1. Use the "Floating measurement" option, while also observing the operating conditions for floating measurement.
2. Connect the connection housing of the transmitter or sensor to ground potential by means of the ground terminal provided for this purpose.

Metal, ungrounded pipe with insulating liner

The sensor and transmitter are installed in a way that provides electrical insulation from PE. The medium and pipe have different potentials. The "Floating measurement" option minimizes harmful equalizing currents between P_M and P_p via the reference electrode.

Starting conditions:

- Metal pipe with insulating liner
- Equalizing currents through the medium cannot be ruled out.

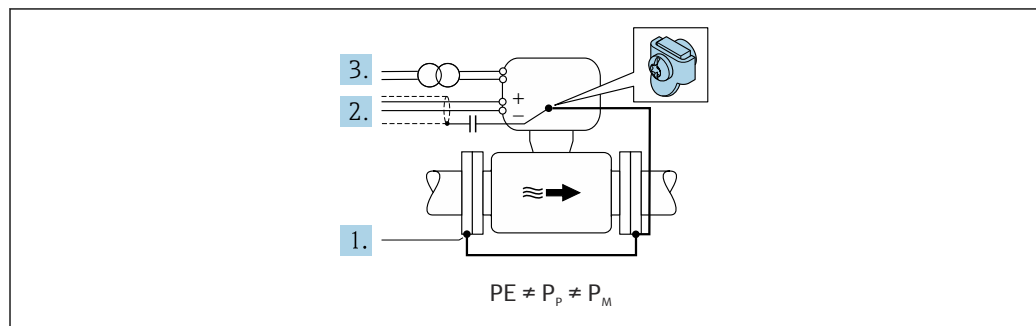

A0044857

1. Connect the pipe flanges and transmitter via the ground cable.
2. Route the shielding of the signal cables via a capacitor (recommended value $1.5\mu\text{F}/50\text{V}$).
3. Device connected to power supply such that it is floating in relation to the protective earth (isolation transformer). This measure is not required in the case of 24V DC supply voltage without PE (= SELV power unit).
4. Use the "Floating measurement" option, while also observing the operating conditions for floating measurement.

Terminals

Spring-loaded terminals: Suitable for strands and strands with ferrules.
Conductor cross-section 0.2 to 2.5 mm^2 (24 to 12 AWG).

Cable entries

- Cable gland: $M20 \times 1.5$ with cable \varnothing 6 to 12 mm (0.24 to 0.47 in)
- Thread for cable entry:
 - NPT $\frac{1}{2}$ "
 - G $\frac{1}{2}$ "
 - M20
- Device plug for digital communication: M12
Only available for certain device versions → 33.

Cable specification

Permitted temperature range

- The installation guidelines that apply in the country of installation must be observed.
- The cables must be suitable for the minimum and maximum temperatures to be expected.

Power supply cable (incl. conductor for the inner ground terminal)

Standard installation cable is sufficient.

Protective grounding cable for the outer ground terminal

Conductor cross-section < 2.1 mm² (14 AWG)

The use of a cable lug enables the connection of larger cross-sections.

The grounding impedance must be less than 2 Ω.

Signal cable

Current output 4 to 20 mA HART

A shielded cable is recommended. Observe grounding concept of the plant.

PROFIBUS PA

Twisted, shielded two-wire cable. Cable type A is recommended .



For further information on planning and installing PROFIBUS networks see:

- Operating Instructions "PROFIBUS DP/PA: Guidelines for planning and commissioning" (BA00034S)
- PNO Directive 2.092 "PROFIBUS PA User and Installation Guideline"
- IEC 61158-2 (MBP)

PROFIBUS DP

The IEC 61158 standard specifies two types of cable (A and B) for the bus line which can be used for every transmission rate. Cable type A is recommended.

Cable type	A
Characteristic impedance	135 to 165 Ω at a measuring frequency of 3 to 20 MHz
Cable capacitance	< 30 pF/m
Wire cross-section	> 0.34 mm ² (22 AWG)
Cable type	Twisted pairs
Loop resistance	≤110 Ω/km
Signal damping	Max. 9 dB over the entire length of the cable cross-section
Shield	Copper braided shielding or braided shielding with foil shield. When grounding the cable shield, observe the grounding concept of the plant.



For further information on planning and installing PROFIBUS networks see:

- Operating Instructions "PROFIBUS DP/PA: Guidelines for planning and commissioning" (BA00034S)
- PNO Directive 2.092 "PROFIBUS PA User and Installation Guideline"
- IEC 61158-2 (MBP)

EtherNet/IP

The standard ANSI/TIA/EIA-568-B.2 Annex specifies CAT 5 as the minimum category for a cable used for EtherNet/IP. CAT 5e and CAT 6 are recommended.



For more information on planning and installing EtherNet/IP networks, please refer to the "Media Planning and Installation Manual. EtherNet/IP" of ODVA Organization

PROFINET

Standard IEC 61156-6 specifies CAT 5 as the minimum category for a cable used for PROFINET. CAT 5e and CAT 6 are recommended.



For more information on planning and installing PROFINET networks, see: "PROFINET Cabling and Interconnection Technology", Guideline for PROFINET

PROFINET with Ethernet-APL

The reference cable type for APL segments is fieldbus cable type A, MAU type 1 and 3 (specified in IEC 61158-2). This cable meets the requirements for intrinsically safe applications according to IEC TS 60079-47 and can also be used in non-intrinsically safe applications.

Cable type	A
Cable capacitance	45 to 200 nF/km
Loop resistance	15 to 150 Ω/km
Cable inductance	0.4 to 1 mH/km

Further details are provided in the Ethernet-APL Engineering Guideline (<https://www.ethernet-apl.org>).

FOUNDATION Fieldbus

Twisted, shielded two-wire cable.



For further information on planning and installing FOUNDATION Fieldbus networks see:

- Operating Instructions for "FOUNDATION Fieldbus Overview" (BA00013S)
- FOUNDATION Fieldbus Guideline
- IEC 61158-2 (MBP)

Modbus RS485

The EIA/TIA-485 standard specifies two types of cable (A and B) for the bus line which can be used for every transmission rate. Cable type A is recommended.

Cable type	A
Characteristic impedance	135 to 165 Ω at a measuring frequency of 3 to 20 MHz
Cable capacitance	< 30 pF/m
Wire cross-section	> 0.34 mm ² (22 AWG)
Cable type	Twisted pairs
Loop resistance	≤110 Ω/km
Signal damping	Max. 9 dB over the entire length of the cable cross-section
Shield	Copper braided shielding or braided shielding with foil shield. When grounding the cable shield, observe the grounding concept of the plant.

Current output 0/4 to 20 mA

Standard installation cable is sufficient

Pulse /frequency /switch output

Standard installation cable is sufficient

Double pulse output

Standard installation cable is sufficient

Relay output

Standard installation cable is sufficient.

Current input 0/4 to 20 mA

Standard installation cable is sufficient

Status input

Standard installation cable is sufficient

Choice of connecting cable between the transmitter and sensor

Depends on the type of transmitter and the installation zones

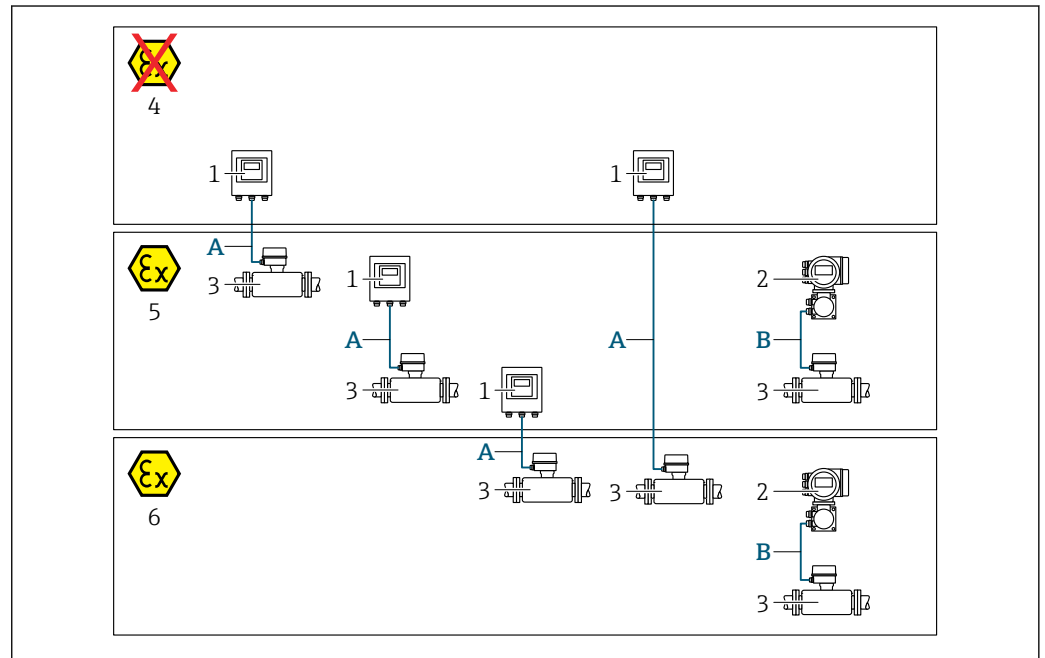

A0032477

- 1 Proline 500 digital transmitter
- 2 Proline 500 transmitter
- 3 Promag sensor
- 4 Non-hazardous area
- 5 Hazardous area: Zone 2; Class I, Division 2
- 6 Hazardous area: Zone 1; Class I, Division 1
- A Standard cable to 500 digital transmitter → 55
Transmitter installed in the non-hazardous area or hazardous area: Zone 2; Class I, Division 2 / sensor installed in the hazardous area: Zone 2; Class I, Division 2 or Zone 1; Class I, Division 1
- B Signal cable to 500 transmitter → 56
Transmitter and sensor installed in the hazardous area: Zone 2; Class I, Division 2 or Zone 1; Class I, Division 1

A: Connecting cable between sensor and transmitter: Proline 500 – digital

Standard cable

A standard cable with the following specifications can be used as the connecting cable.

Design	4 cores (2 pairs); uninsulated stranded CU wires; pair-stranded with common shield
Shielding	Tin-plated copper braid, optical cover ≥ 85 %
Cable length	Maximum 300 m (900 ft), see the following table.

Cross-section	Cable lengths for use in	
	Non-hazardous area, Hazardous area: Zone 2; Class I, Division 2	Hazardous area: Zone 1; Class I, Division 1
0.34 mm ² (AWG 22)	80 m (240 ft)	50 m (150 ft)
0.50 mm ² (AWG 20)	120 m (360 ft)	60 m (180 ft)
0.75 mm ² (AWG 18)	180 m (540 ft)	90 m (270 ft)
1.00 mm ² (AWG 17)	240 m (720 ft)	120 m (360 ft)

Cross-section	Cable lengths for use in	
	Non-hazardous area, Hazardous area: Zone 2; Class I, Division 2	Hazardous area: Zone 1; Class I, Division 1
1.50 mm ² (AWG 15)	300 m (900 ft)	180 m (540 ft)
2.50 mm ² (AWG 13)	300 m (900 ft)	300 m (900 ft)

Optionally available connecting cable

Design	2 × 2 × 0.34 mm ² (AWG 22) PVC cable ¹⁾ with common shield (2 pairs, uninsulated stranded CU wires; pair-stranded)
Flame resistance	According to DIN EN 60332-1-2
Oil-resistance	According to DIN EN 60811-2-1
Shielding	Tin-plated copper braid, optical cover ≥ 85 %
Operating temperature	When mounted in a fixed position: -50 to +105 °C (-58 to +221 °F); when cable can move freely: -25 to +105 °C (-13 to +221 °F)
Available cable length	Fixed: 20 m (60 ft); variable: up to maximum 50 m (150 ft)

1) UV radiation can impair the cable outer sheath. Protect the cable from direct sunshine where possible.

B: Connecting cable between sensor and transmitter: Proline 500

Signal cable

Design	3 × 0.38 mm ² (20 AWG) with common, braided copper shield (∅ ~ 9.5 mm (0.37 in)) and individual shielded cores
Conductor resistance	≤ 50 Ω/km (0.015 Ω/ft)
Capacitance: core/shield	≤ 420 pF/m (128 pF/ft)
Cable length (max.)	Depends on the medium conductivity, max. 200 m (656 ft)
Cable lengths (available for order)	5 m (15 ft), 10 m (30 ft), 20 m (60 ft) or variable length up to max. 200 m (600 ft)
Cable diameter	9.4 mm (0.37 in) ± 0.5 mm (0.02 in)
Operating temperature	-20 to +80 °C (-4 to +176 °F)

Coil current cable

Design	3 × 0.75 mm ² (18 AWG) with common, braided copper shield (∅ ~ 9 mm (0.35 in)) and individual shielded cores
Conductor resistance	≤ 37 Ω/km (0.011 Ω/ft)
Capacitance: core/core, shield grounded	≤ 120 pF/m (37 pF/ft)
Cable length (max.)	Depends on the medium conductivity, max. 200 m (656 ft)
Cable lengths (available for order)	5 m (15 ft), 10 m (30 ft), 20 m (60 ft) or variable length up to max. 200 m (600 ft)
Cable diameter	8.8 mm (0.35 in) ± 0.5 mm (0.02 in)
Continuous operating temperature	-20 to +80 °C (-4 to +176 °F)
Test voltage for cable insulation	≤ AC 1433 V rms 50/60 Hz or ≥ DC 2026 V

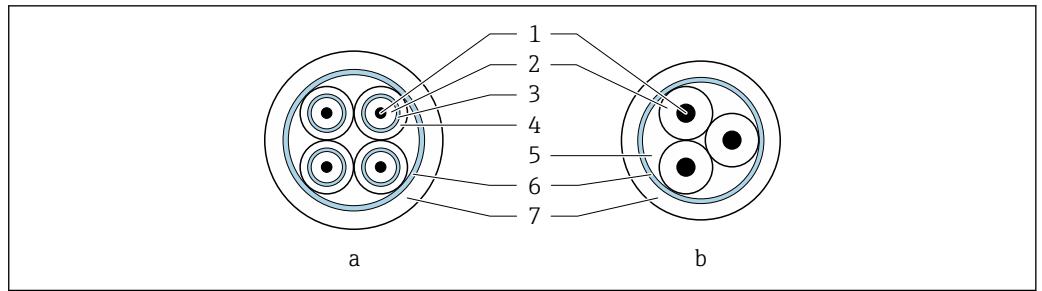

A0029151

22 Cable cross-section

- a Electrode cable
- b Coil current cable
- 1 Core
- 2 Core insulation
- 3 Core shield
- 4 Core jacket
- 5 Core reinforcement
- 6 Cable shield
- 7 Outer jacket

- i** A connecting cable can be ordered from Endress+Hauser for IP68:
 - Pre-terminated cables that are already connected to the sensor
 - Pre-terminated cables, where the cables are connected by the customer onsite (incl. tools for sealing the connection compartment)

Operation in zones of severe electrical interference

The measuring system meets the general safety requirements → 117 and EMC specifications → 72.

Grounding is by means of the ground terminal provided for the purpose inside the connection housing. The stripped and twisted lengths of cable shield to the ground terminal must be as short as possible.

Overvoltage protection

Mains voltage fluctuations	→ 36
Overvoltage category	Overvoltage category II
Short-term, temporary overvoltage	Up to 1200 V between cable and ground, for max. 5 s
Long-term, temporary overvoltage	Up to 500 V between cable and ground

Performance characteristics

Reference operating conditions

- Error limits following DIN EN 29104, in future ISO 20456
- Water, typically: +15 to +45 °C (+59 to +113 °F); 0.5 to 7 bar (73 to 101 psi)
- Data as indicated in the calibration protocol
- Accuracy based on accredited calibration rigs according to ISO 17025

Maximum measured error

o.r. = of reading

Error limits under reference operating conditions

Volume flow

- ±0.5 % o.r. ± 1 mm/s (0.04 in/s)
- Optional: ±0.2 % o.r. ± 2 mm/s (0.08 in/s)

- i** Fluctuations in the supply voltage do not have any effect within the specified range.

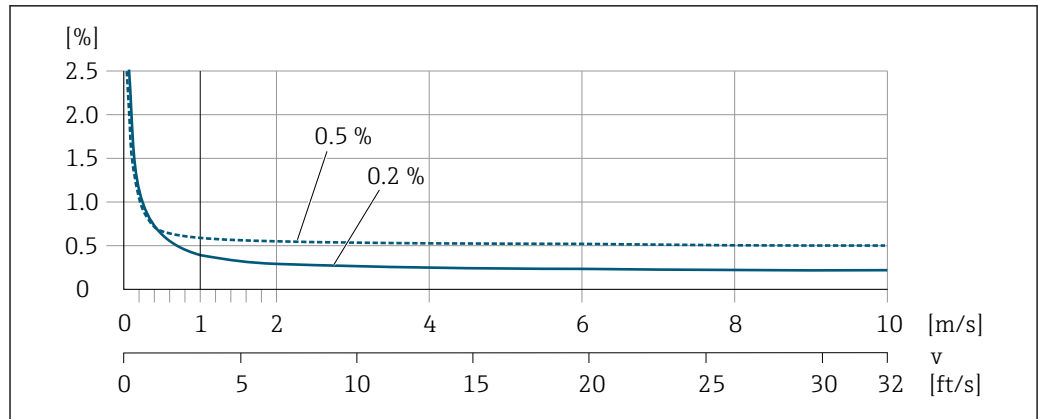

A0028974

23 Maximum measured error in % o.r.

Flat Spec

In the case of Flat Spec, the measured error is constant in the range from $v_{0,5}$ ($v_{0,2}$) to v_{max} .

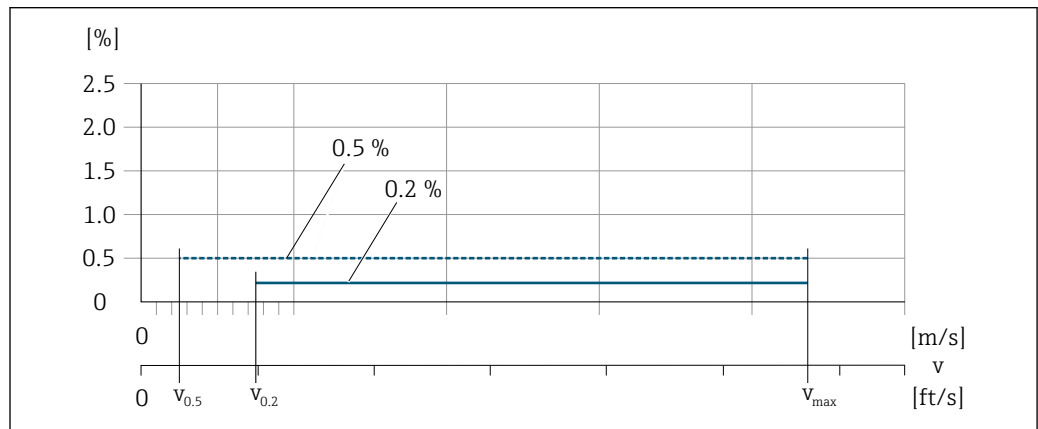

A0017051

24 Flat Spec in % o.r.

Flat Spec flow values 0.5 %

Nominal diameter		$v_{0,5}$		v_{max}	
[mm]	[in]	[m/s]	[ft/s]	[m/s]	[ft/s]
25 to 600	1 to 24	0.5	1.64	10	32
50 to 300	2 to 12	0.25	0.82	5	16

Flat Spec flow values 0.2 %

Nominal diameter		$v_{0,2}$		v_{max}	
[mm]	[in]	[m/s]	[ft/s]	[m/s]	[ft/s]
25 to 600	1 to 24	1.5	4.92	10	32
50 to 300	2 to 12	0.6	1.97	4	13

Electrical conductivity

The values apply for:

- Proline 500 – digital device version
- Devices installed in a metal pipe or in a non-metal pipe with ground disks
- Devices whose potential equalization was performed according to the instructions in the associated Operating Instructions
- Measurements at a reference temperature of 25 °C (77 °F). At different temperatures, attention must be paid to the temperature coefficient of the medium (typically 2.1 %/K)

Conductivity [$\mu\text{S}/\text{cm}$]	Measured error [%] of reading
5 to 20	$\pm 20\%$
> 20 to 50	$\pm 10\%$
> 50 to 10 000	<ul style="list-style-type: none"> ■ Standard: $\pm 10\%$ ■ Optional ¹⁾: $\pm 5\%$
> 10 000 to 20 000	$\pm 10\%$
> 20 000 to 100 000	$\pm 20\%$

1) Order code for "Calibrated conductivity measurement", option CW

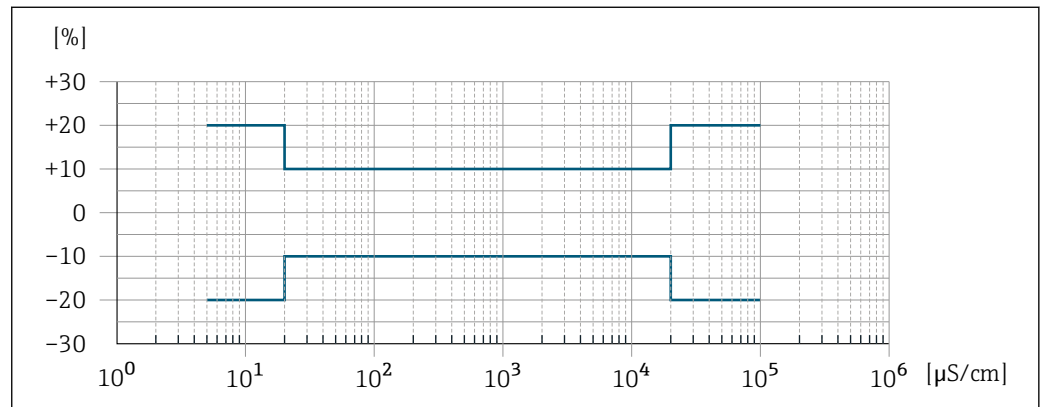

25 Measured error (standard)

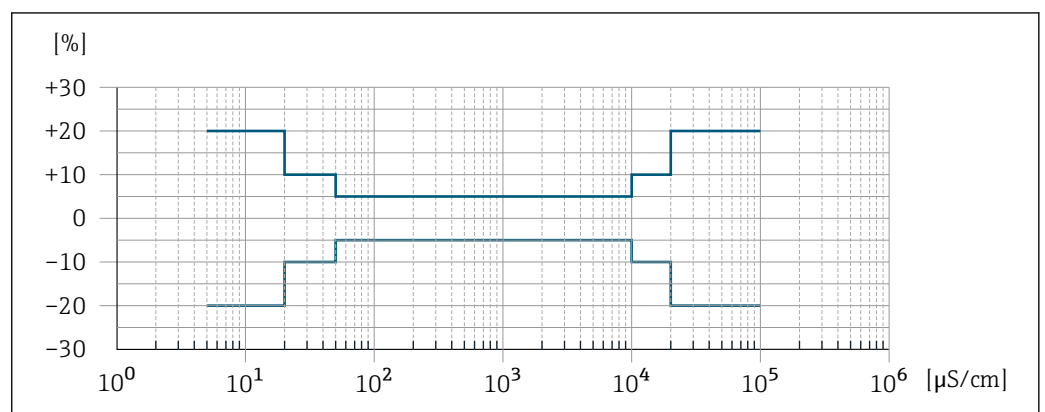

26 Measured error (optional: order code for "Calibrated conductivity measurement", option CW)

Accuracy of outputs

The outputs have the following base accuracy specifications.

Current output

Accuracy	$\pm 5 \mu\text{A}$
----------	---------------------

Pulse/frequency output

o.r. = of reading

Accuracy	Max. ± 50 ppm o.r. (over the entire ambient temperature range)
-----------------	--------------------------------------------------------------------

Repeatability

o.r. = of reading

Volume flowMax. ± 0.1 % o.r. ± 0.5 mm/s (0.02 in/s)**Electrical conductivity**

- Max. ± 5 % o.r.
- With order code for "Calibrated conductivity measurement", option CW: ± 2 % v.M.

Influence of ambient temperature**Current output**

Temperature coefficient	Max. $1 \mu\text{A}/^\circ\text{C}$
--------------------------------	-------------------------------------

Pulse/frequency output

Temperature coefficient	No additional effect. Included in accuracy.
--------------------------------	---------------------------------------------

Installation

Mounting location

- Do not install the device at the highest point of the pipe.
- Do not install the device upstream from a free pipe outlet in a down pipe.

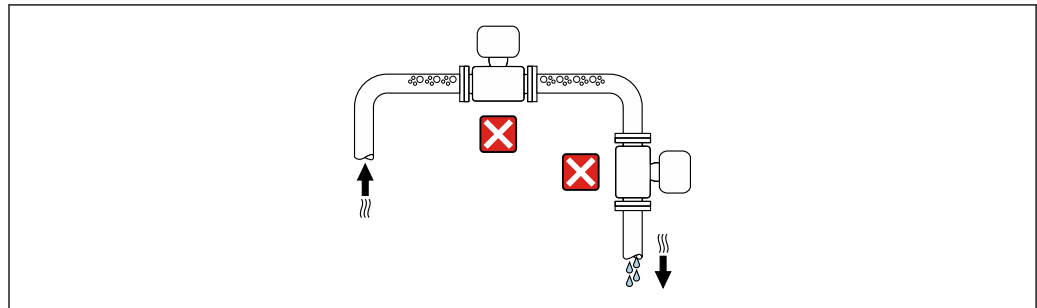

A0042131

The device should ideally be installed in an ascending pipe.

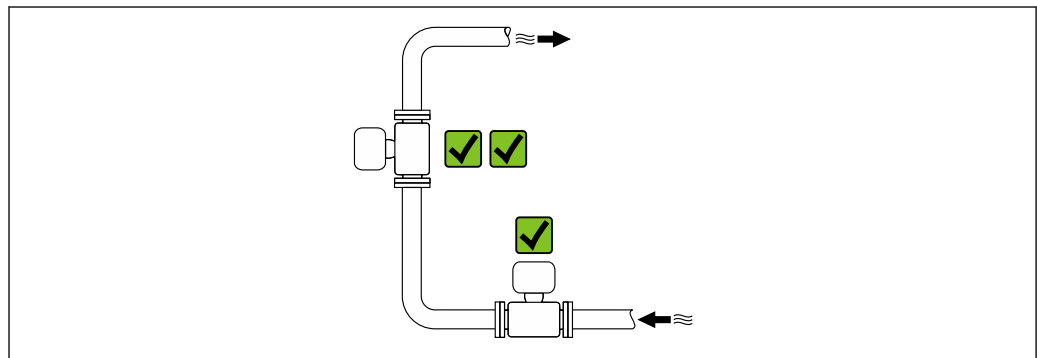

A0042317

Installation near valves

Install the device in the direction of flow upstream from the valve.

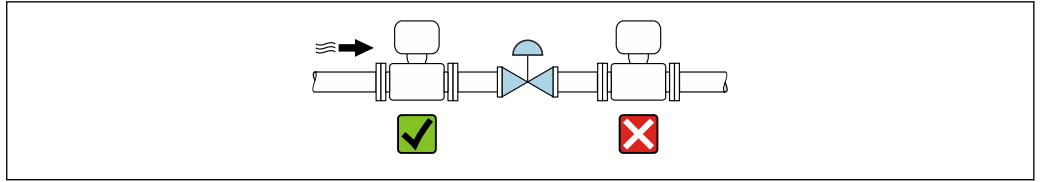

A0041091

Installation upstream from a down pipe

NOTICE

Negative pressure in the measuring pipe can damage the liner!

- ▶ If installing upstream of down pipes whose length $h \geq 5 \text{ m}$ (16.4 ft): install a siphon with a vent valve downstream of the device.

i This arrangement prevents the flow of liquid stopping in the pipe and air entrainment.

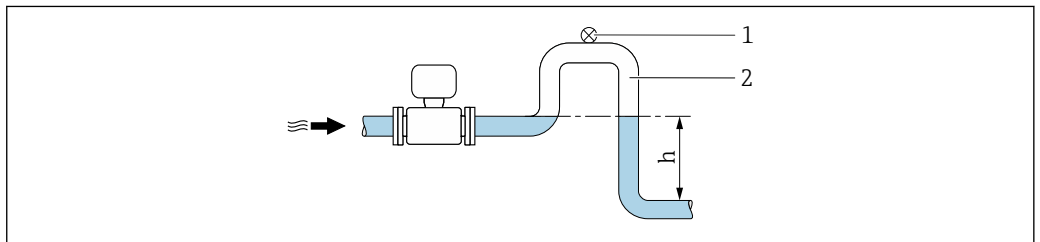

A0028981

- 1 Vent valve
- 2 Pipe siphon
- h Length of down pipe

Installation with partially filled pipes

- Partially filled pipes with a gradient require a drain-type configuration.
- The installation of a cleaning valve is recommended.

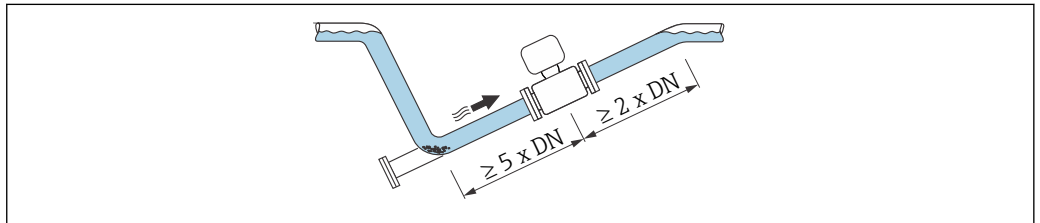

A0041088

Installation near pumps

NOTICE

Negative pressure in the measuring pipe can damage the liner!

- ▶ In order to maintain the system pressure, install the device in the flow direction downstream from the pump.
- ▶ Install pulsation dampers if reciprocating, diaphragm or peristaltic pumps are used.

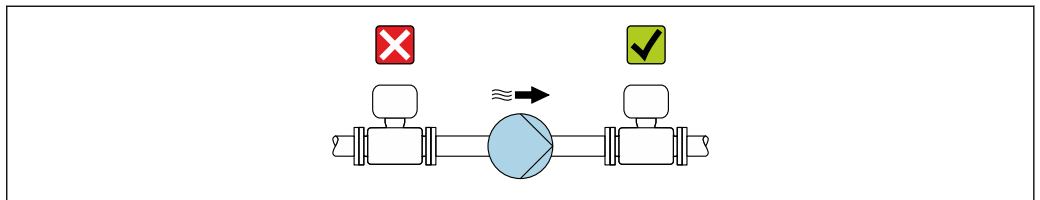

A0041083

- i** Information on the liner's resistance to partial vacuum
- Information on the measuring system's resistance to vibration and shock → 71

Installation of very heavy devices

Support required for nominal diameters of $DN \geq 350$ mm (14 in).

NOTICE

Damage to the device!

If incorrect support is provided, the sensor housing could buckle and the internal magnetic coils could be damaged.

- ▶ Only provide supports at the pipe flanges.

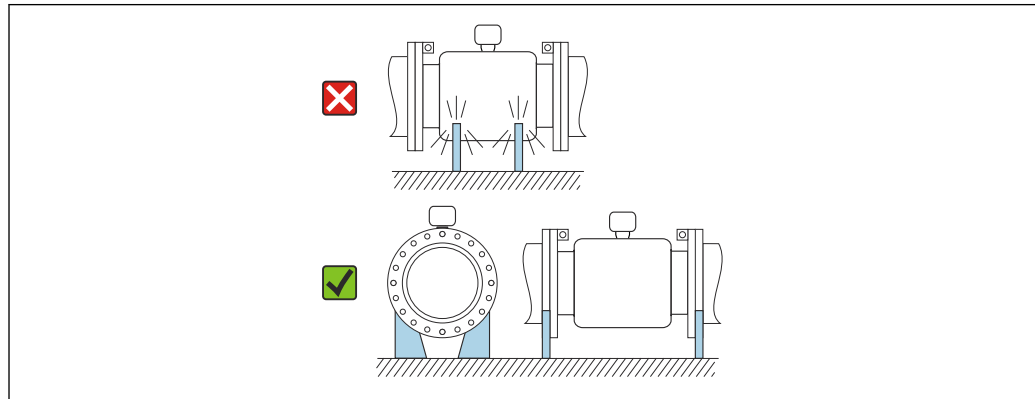

A0041087

Installation in event of pipe vibrations

A remote version is recommended in the event of strong pipe vibrations.

NOTICE

Pipe vibrations can damage the device!

- ▶ Do not expose the device to strong vibrations.
- ▶ Support the pipe and fix it in place.
- ▶ Support the device and fix it in place.
- ▶ Mount the sensor and transmitter separately.

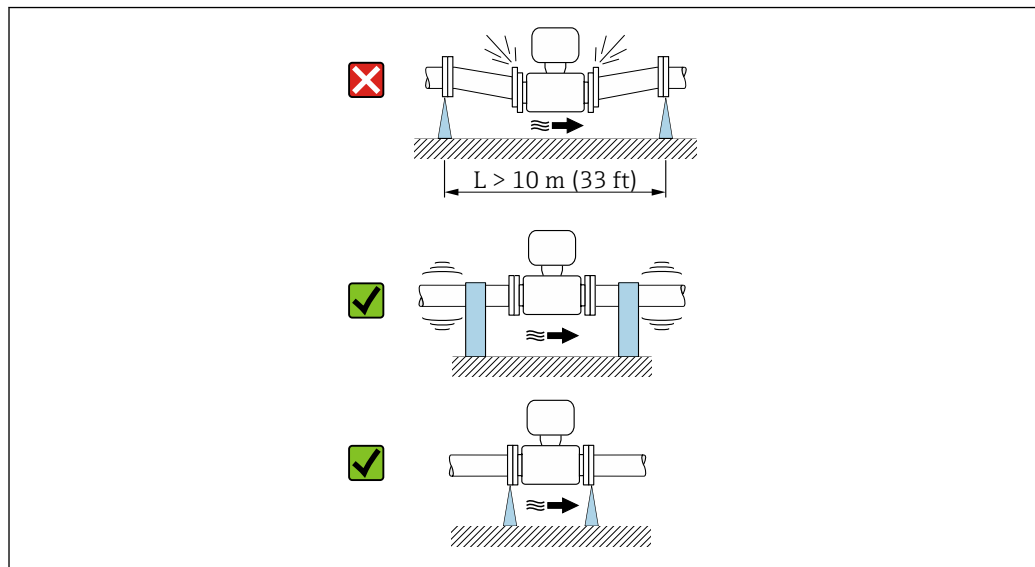









A0041092

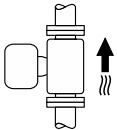

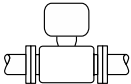
Information on the measuring system's resistance to vibration and shock → 71

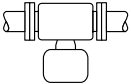
Orientation

The direction of the arrow on the sensor nameplate helps you to install the sensor according to the flow direction (direction of medium flow through the piping).

Orientation		Recommendation
Vertical orientation	 <p style="text-align: right; font-size: small;">A0015591</p>	
Horizontal orientation, transmitter at top	 <p style="text-align: right; font-size: small;">A0015589</p>	 ¹⁾
Horizontal orientation, transmitter at bottom	 <p style="text-align: right; font-size: small;">A0015590</p>	 ^{2) 3)}  ⁴⁾
Horizontal orientation, transmitter at side	 <p style="text-align: right; font-size: small;">A0015592</p>	

- 1) Applications with low process temperatures may reduce the ambient temperature. To maintain the minimum ambient temperature for the transmitter, this orientation is recommended.
- 2) Applications with high process temperatures may increase the ambient temperature. To maintain the maximum ambient temperature for the transmitter, this orientation is recommended.
- 3) To prevent the electronics from overheating in the event of strong heat formation (e.g. CIP or SIP cleaning process), install the device with the transmitter part pointing downwards.
- 4) When the empty pipe detection function is switched on, empty pipe detection only works if the transmitter housing is pointing upwards.

Vertical

Optimum for self-emptying pipe systems and for use in conjunction with empty pipe detection.

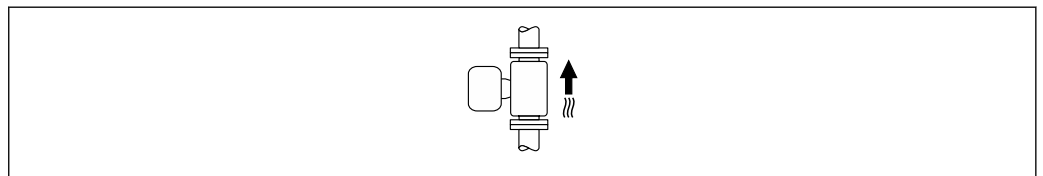

Horizontal

- Ideally, the measuring electrode plane should be horizontal. This prevents brief insulation of the measuring electrodes by entrained air bubbles.
- Empty pipe detection only works if the transmitter housing is pointing upwards as otherwise there is no guarantee that the empty pipe detection function will actually respond to a partially filled or empty measuring tube.

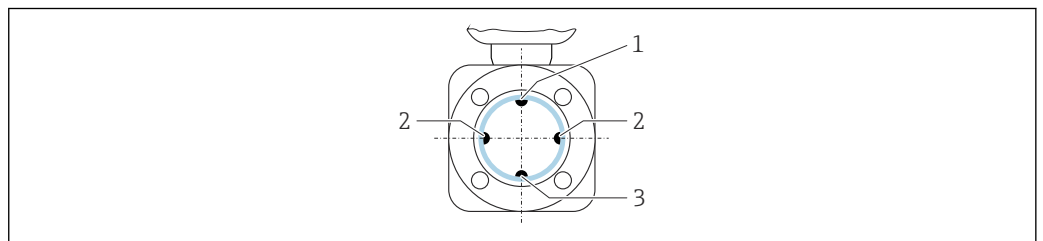

- 1 EPD electrode for empty pipe detection
- 2 Measuring electrodes for signal detection
- 3 Reference electrode for potential equalization

 Measuring devices with tantalum or platinum electrodes can be ordered without an EPD electrode. In this case, empty pipe detection is performed via the measuring electrodes.

Inlet and outlet runs**Installation with inlet and outlet runs***Installation with elbows, pumps or valves*

To avoid a vacuum and to maintain the specified level of accuracy, if possible install the device upstream from assemblies that produce turbulence (e.g. valves, T-sections) and downstream from pumps.

Maintain straight, unimpeded inlet and outlet runs.

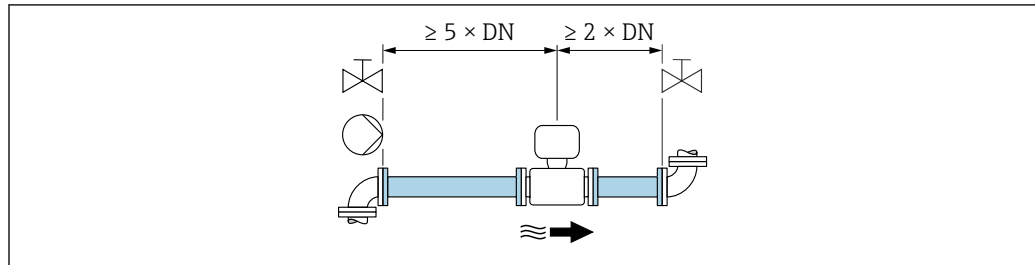

A0028997

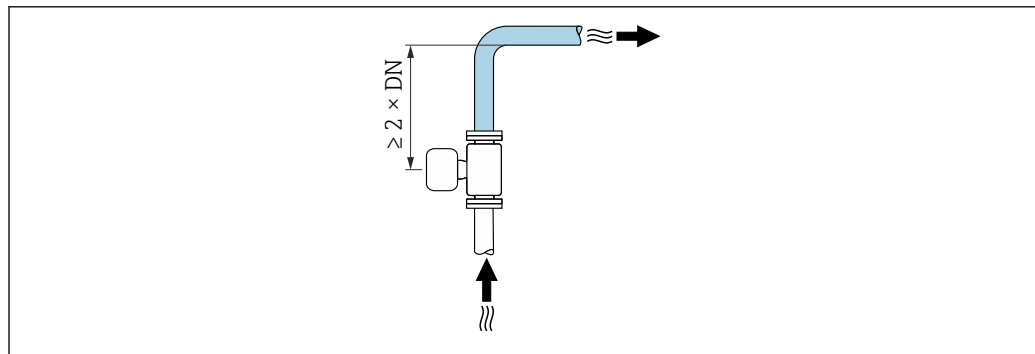

A0042132

Installation without inlet and outlet runs

Depending on the device design and installation location, the inlet and outlet runs can be reduced or omitted entirely.

Devices and possible order options on request.

 Maximum measured error

When the device is installed with the inlet and outlet runs described, a maximum measured error of $\pm 0.5\%$ of the reading ± 1 mm/s (0.04 in/s) can be guaranteed.

Installation before or after bends

Installation without inlet and outlet runs is possible.

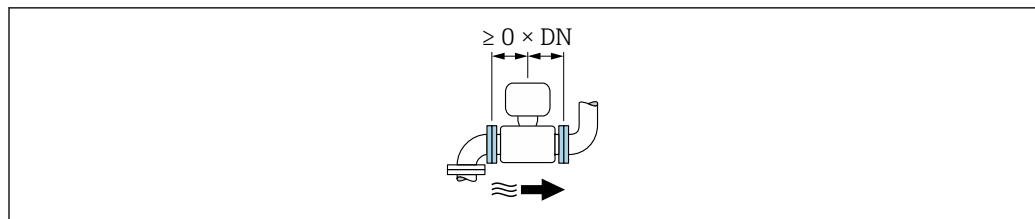
*Installation downstream of pumps*

Installation without inlet and outlet runs is possible.

Installation upstream of valves

Installation without inlet and outlet runs is possible.

Installation downstream of valves

Installation without inlet and outlet runs is possible if the valve is 100% open during operation.

Adapters

Suitable adapters to DIN EN 545 (double-flange reducers) can be used to install the sensor in larger-diameter pipes. The resultant increase in the rate of flow improves measuring accuracy with very slow-moving fluids.

The nomogram shown here can be used to calculate the pressure loss caused by reducers and expanders:

- Calculate the ratio of the diameters d/D .
- From the nomogram read off the pressure loss as a function of flow velocity (downstream from the reduction) and the d/D ratio.

 The nomogram only applies to liquids with a viscosity similar to that of water.

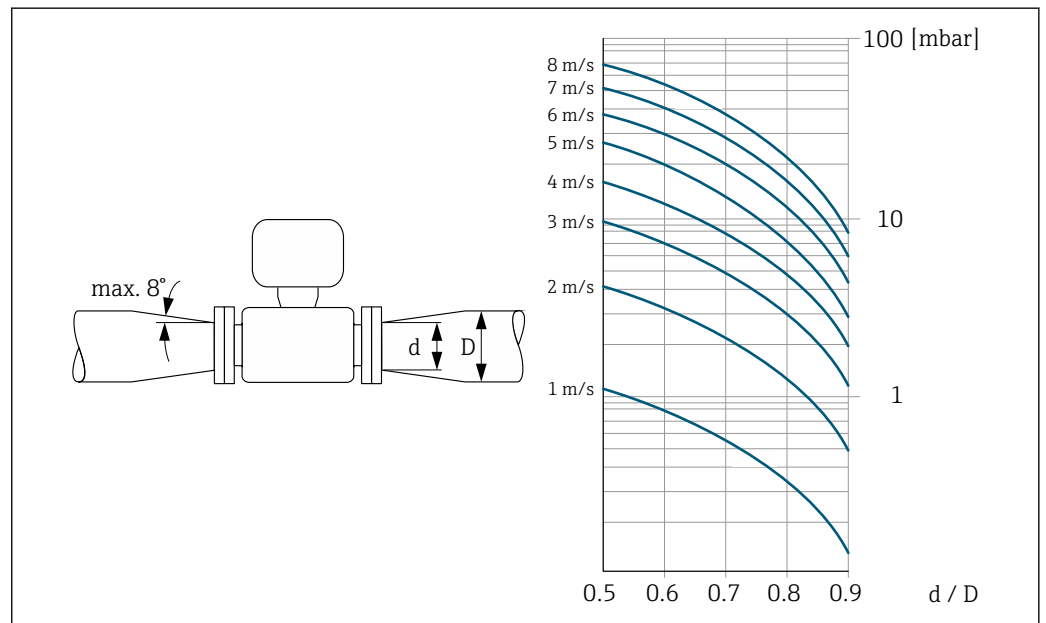

A0029002

Length of connecting cable

Proline 500 – digital transmitter

Lengths of connecting cable →  55

Proline 500 transmitter

Max. 200 m (650 ft)

To obtain correct measurement results, observe the permitted connecting cable length of L_{max} . This length is determined by the conductivity of the medium. If measuring liquids in general: $5 \mu\text{S}/\text{cm}$

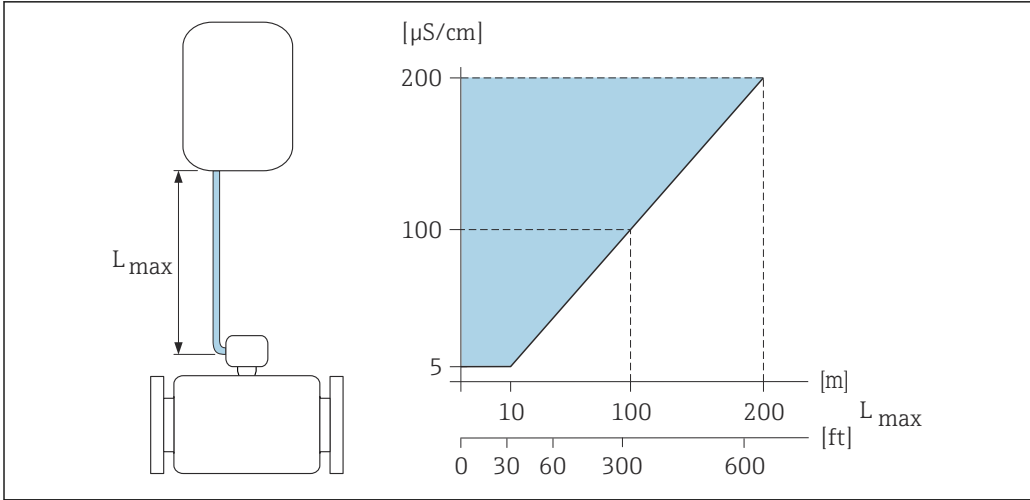

A0016539

27 Permitted length of connecting cable

Colored area = permitted range
 L_{max} = length of connecting cable in [m] ([ft])
 $[\mu S/cm]$ = medium conductivity

Mounting the transmitter housing

Proline 500 – digital transmitter

Post mounting

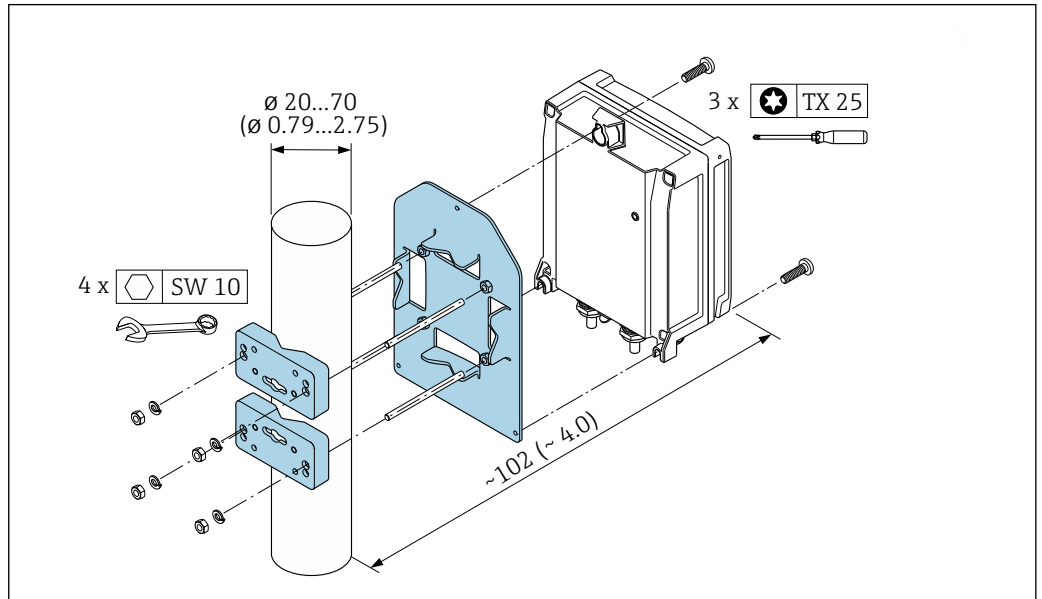

A0029051

28 Engineering unit mm (in)

Wall mounting

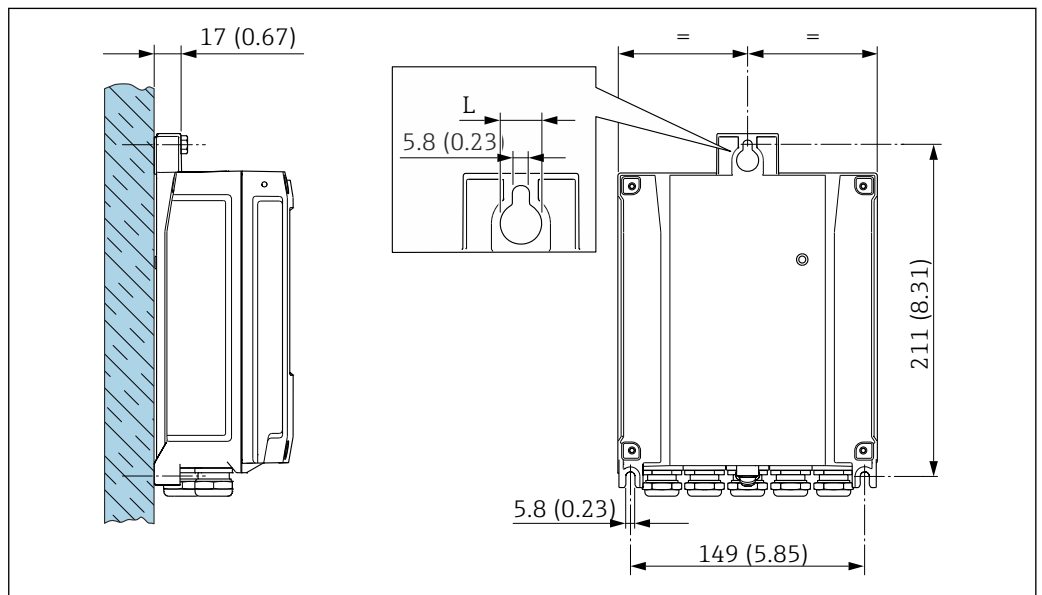

A0029054

29 Engineering unit mm (in)

L Depends on order code for "Transmitter housing"

Order code for "Transmitter housing"

- Option **A**, aluminum, coated: L = 14 mm (0.55 in)
- Option **D**, polycarbonate: L = 13 mm (0.51 in)

Proline 500 transmitter

Post mounting



Order code for "Transmitter housing", option L "Cast, stainless": cast transmitters are very heavy.

They are unstable if they are not mounted on a secure, fixed post.

- ▶ Only mount the transmitter on a secure, fixed post on a stable surface.

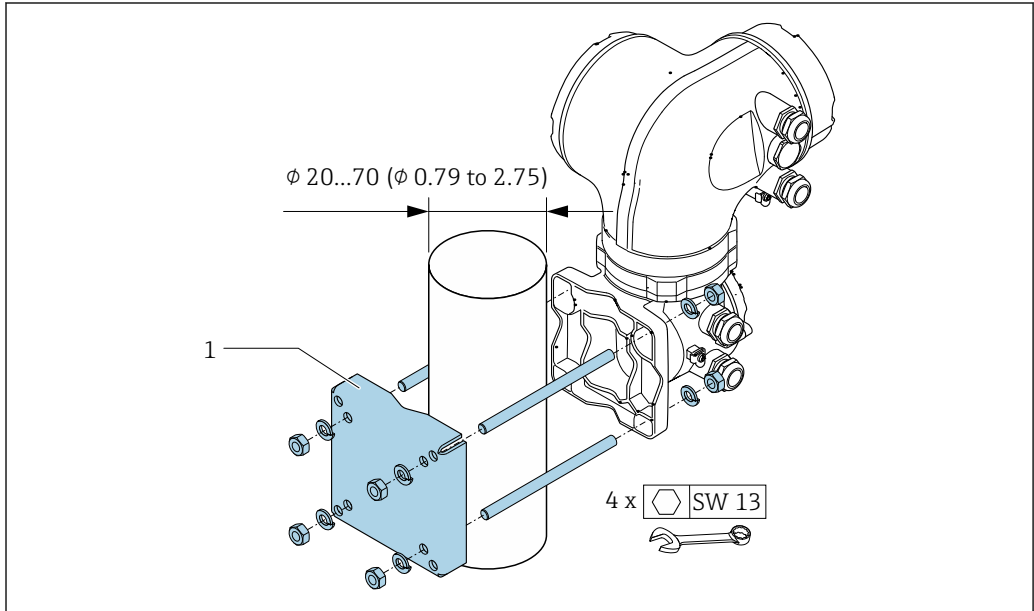

A0029057

30 Engineering unit mm (in)

Wall mounting

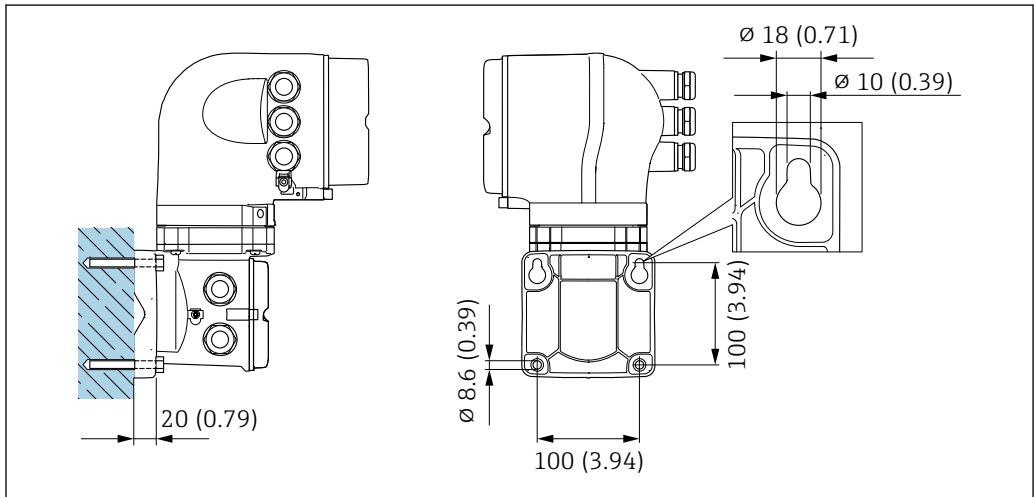

A0029068

31 Engineering unit mm (in)

Special mounting instructions

Weather protection cover

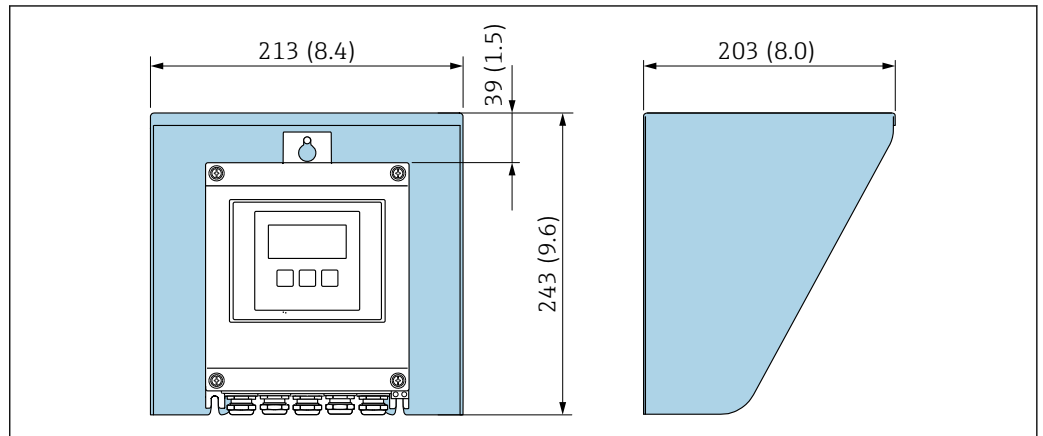

32 Weather protection cover for Proline 500 – digital; engineering unit mm (in)

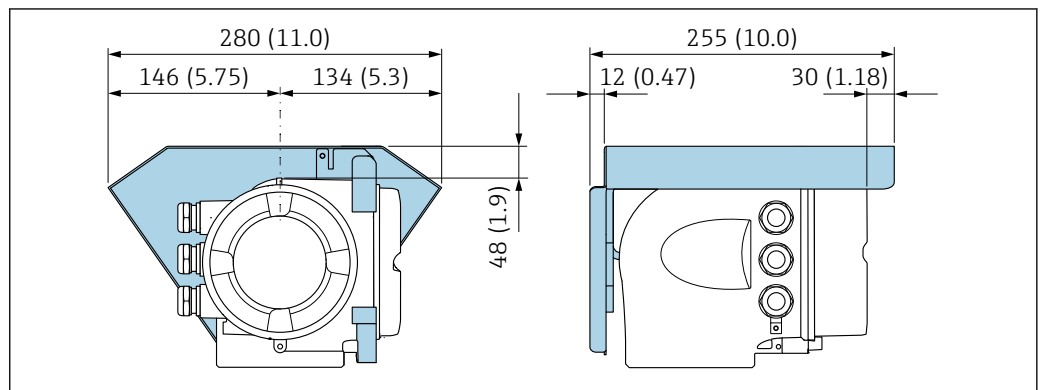

33 Weather protection cover for Proline 500; engineering unit mm (in)

Immersion in water

- i** Only the remote version of the device with IP68 protection, Type 6P is suitable for underwater use: order code for "Sensor option", options CB, CC and CQ.
- Pay attention to regional installation instructions.

NOTICE

If the maximum water depth and operating duration is exceeded, this can damage the device!

- Observe the maximum water depth and operating duration.

Order code for "Sensor option", options CB, CC

- For the operation of the device under water
- Operating duration at a maximum depth of:
 - 3 m (10 ft): permanent use
 - 10 m (30 ft): maximum 48 hours

Order code for "Sensor option", option CQ "Temporarily water-proof"

- For the temporary operation of the device under non-corrosive water
- Operating duration at a maximum depth of:
 - 3 m (10 ft): maximum 168 hours

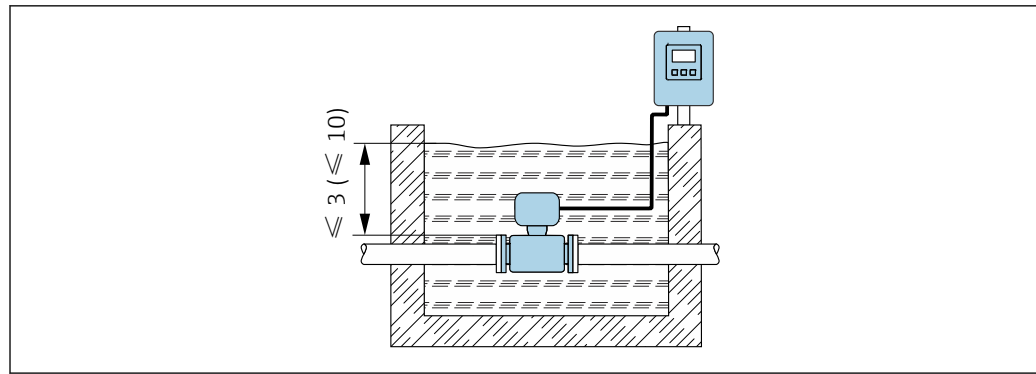

A0042412

Environment

Ambient temperature range	Transmitter	<ul style="list-style-type: none"> ■ Standard: -40 to $+60$ °C (-40 to $+140$ °F) ■ Optional: -50 to $+60$ °C (-58 to $+140$ °F) (Order code for "Test, certificate", option JN "Ambient temperature of transmitter -50 °C (-58 °F)")
	Local display	-20 to $+60$ °C (-4 to $+140$ °F), the readability of the display may be impaired at temperatures outside the temperature range.
	Sensor	<ul style="list-style-type: none"> ■ Process connection material, carbon steel: -10 to $+60$ °C ($+14$ to $+140$ °F) ■ Process connection material, stainless steel: -40 to $+60$ °C (-40 to $+140$ °F) <p>If both the ambient and the medium temperatures are high, mount the sensor separately from the transmitter.</p>
	Liner	Do not exceed or fall below the permitted temperature range of the liner .

If operating outdoors:

- Install the measuring device in a shady location.
- Avoid direct sunlight, particularly in warm climatic regions.
- Avoid direct exposure to weather conditions.

Storage temperature	<p>The storage temperature corresponds to the operating temperature range of the transmitter and the sensor → 70.</p> <ul style="list-style-type: none"> ■ Protect the measuring device against direct sunlight during storage in order to avoid unacceptably high surface temperatures. ■ Select a storage location where moisture cannot collect in the measuring device as fungus or bacteria infestation can damage the liner. ■ If protection caps or protective covers are mounted these should never be removed before installing the measuring device.
----------------------------	--------------------------------------------------------------------------------------------------------------------------------------------------------------------------------------------------------------------------------------------------------------------------------------------------------------------------------------------------------------------------------------------------------------------------------------------------------------------------------------------------------------------------------------------------------------------------------------------------

Relative humidity	The device is suitable for use in outdoor and indoor areas with a relative humidity of 4 to 95%.
--------------------------	--------------------------------------------------------------------------------------------------

Operating height	<p>According to EN 61010-1</p> <ul style="list-style-type: none"> ■ $\leq 2\,000$ m (6 562 ft) ■ $> 2\,000$ m (6 562 ft) with additional overvoltage protection (e.g. Endress+Hauser HAW Series)
-------------------------	---------------------------------------------------------------------------------------------------------------------------------------------------------------------------------------------------------------------------------------------------

Degree of protection	<p>Transmitter</p> <ul style="list-style-type: none"> ■ IP66/67, Type 4X enclosure, suitable for pollution degree 4 ■ When the housing is open: IP20, Type 1 enclosure, suitable for pollution degree 2 ■ Display module: IP20, Type 1 enclosure, suitable for pollution degree 2
-----------------------------	---------------------------------------------------------------------------------------------------------------------------------------------------------------------------------------------------------------------------------------------------------------------------------------------------------------------------

Sensor

- IP66/67, Type 4X enclosure, suitable for pollution degree 4
- When the housing is open: IP20, Type 1 enclosure, suitable for pollution degree 2

Optionally available for compact and remote version:

Order code for "Sensor option", option C3

- IP66/67, type 4X enclosure
- Fully welded, with protective coating as per EN ISO 12944 C5-M
- For the operation of the device in corrosive environments

Optional

Order code for "Sensor option", option CB, CC

- IP68, type 6P enclosure
- Fully welded, with protective coating as per EN ISO 12944 C5-M/Im1 and EN 60529
- For the operation of the device under water
- Operating duration at a maximum depth of:
 - 3 m (10 ft): permanent use
 - 10 m (30 ft): maximum 48 hours

Order code for "Sensor option", option CQ

- IP68, type 6P, temporarily waterproof
- Sensor with aluminum half-shell housing
- For the temporary operation of the device under non-corrosive water
- Operating duration at a maximum depth of:
 - 3 m (10 ft): maximum 168 hours

External WLAN antenna

IP67

Vibration- and shock-resistance

Sinusoidal vibration according to IEC 60068-2-6

Order code for "Sensor connection housing", option L "Cast alloy, stainless" and order code for "Sensor option", option CG "Extended neck for insulation"

- 2 to 8.4 Hz, 3.5 mm peak
- 8.4 to 2 000 Hz, 1 g peak

Order code for "Sensor connection housing", option A "Aluminum, coated"

- 2 to 8.4 Hz, 7.5 mm peak
- 8.4 to 2 000 Hz, 2 g peak

Vibration broad-band random, according to IEC 60068-2-64

Order code for "Sensor connection housing", option L "Cast alloy, stainless" and order code for "Sensor option", option CG "Extended neck for insulation"

- 10 to 200 Hz, 0.003 g²/Hz
- 200 to 2 000 Hz, 0.001 g²/Hz
- Total: 1.54 g rms

Order code for "Sensor connection housing", option A "Aluminum, coated"

- 10 to 200 Hz, 0.01 g²/Hz
- 200 to 2 000 Hz, 0.003 g²/Hz
- Total: 2.70 g rms

Shock half-sine, according to IEC 60068-2-27

- Order code for "Sensor connection housing", option L "Cast alloy, stainless" and order code for "Sensor option", option CG "Extended neck for insulation"
 - 6 ms 30 g
- Order code for "Sensor connection housing", option A "Aluminum, coated"
 - 6 ms 50 g

Rough handling shocks according to IEC 60068-2-31

Mechanical load

Transmitter housing and sensor connection housing:

- Protect against mechanical effects, such as shock or impact
- Do not use as a ladder or climbing aid

Electromagnetic compatibility (EMC)

- As per IEC/EN 61326 and NAMUR Recommendation 21 (NE 21)
 - Device version with PROFIBUS DP: Complies with emission limits for industry as per EN 50170 Volume 2, IEC 61784
- i** The following applies for PROFIBUS DP: If baud rates > 1.5 Mbaud, an EMC cable entry must be used and the cable shield must continue as far as the terminal wherever possible.
- i** Details are provided in the Declaration of Conformity.
- i** This unit is not intended for use in residential environments and cannot guarantee adequate protection of the radio reception in such environments.

Process**Medium temperature range**

- -20 to +150 °C (-4 to +302 °F) for PFA, DN 25 to 200 (1 to 8")
- -20 to +180 °C (-4 to +356 °F) for PFA high-temperature, DN 25 to 200 (1 to 8")
- -40 to +130 °C (-40 to +266 °F) for PTFE, DN 15 to 600 (½ to 24")

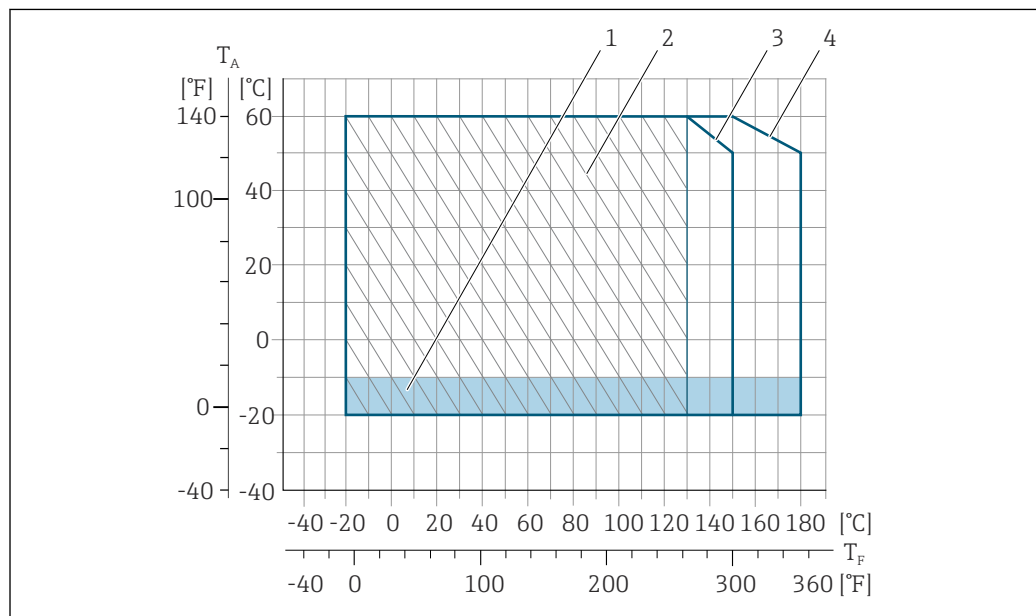

A0029347

34 PFA T_A Ambient temperature T_F Medium temperature

1 Colored area: the ambient temperature range -10 to -20 °C (+14 to -4 °F) applies to stainless flanges only

2 Hatched area: harsh environment only for medium temperature range -20 to +130 °C (-4 to +266 °F)

3 -20 to +150 °C (-4 to +302 °F) for PFA, DN 25 to 200 (1 to 8")

4 -20 to +180 °C (-4 to +356 °F) for PFA high-temperature, DN 25 to 200 (1 to 8")

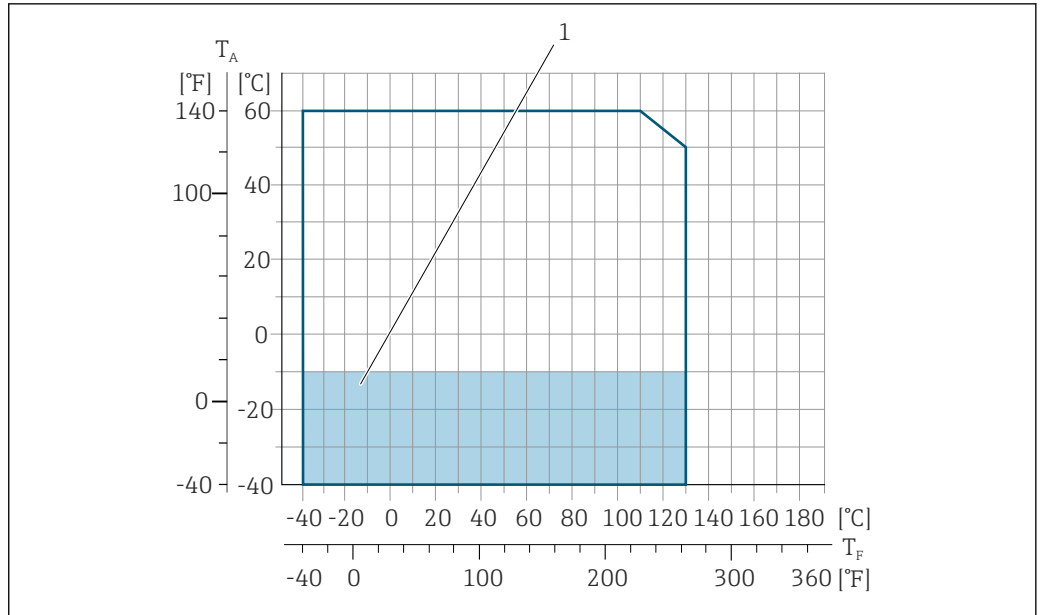

35 PTFE

T_A Ambient temperature

T_F Medium temperature

1 Colored area: the ambient temperature range of -10 to -40 °C (+14 to -40 °F) applies to stainless flanges only

A0029808

Conductivity

≥5 μS/cm for liquids in general.

Proline 500

The necessary minimum conductivity also depends on the length of the connecting cable → 65.

Pressure-temperature ratings

The following pressure/temperature diagrams apply to all pressure-bearing parts of the device and not just the process connection. The diagrams show the maximum permissible medium pressure depending on the specific medium temperature.

Process connection: flange according to EN 1092-1 (DIN 2501)

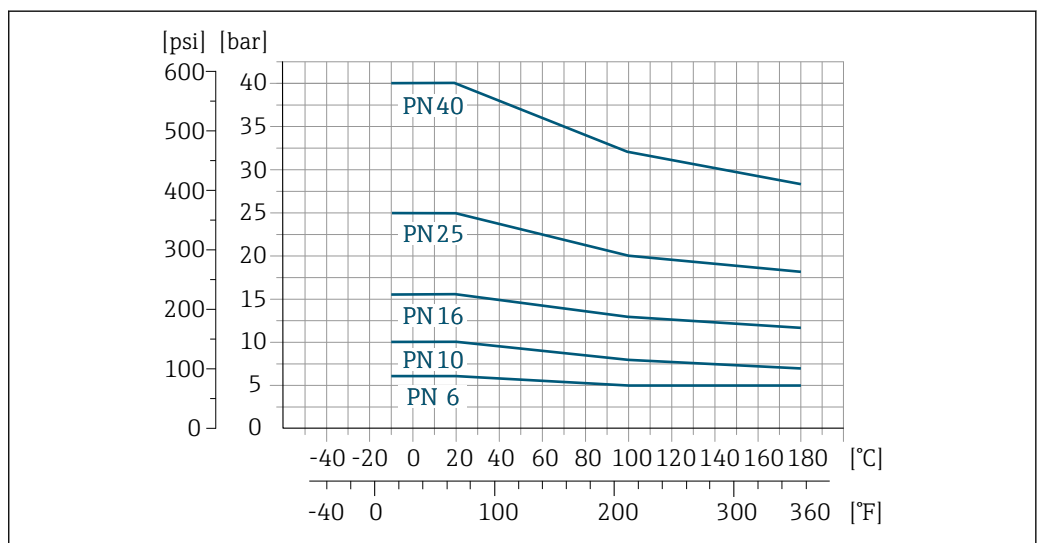

36 Process connection material: carbon steel, FE410WB/S235JRG2; Alloy C22, 2.4602 (UNS N06022)

A0029390-EN

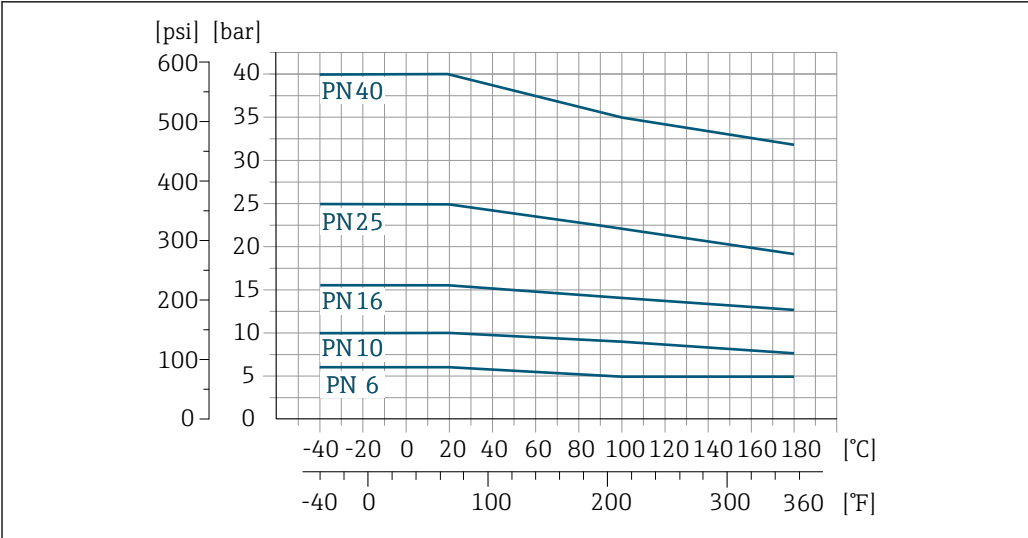

A0029391-EN

37 Process connection material: stainless steel, 1.4571

Process connection: flange according to ASME B16.5



A0029393-EN

38 Process connection material: carbon steel, A105

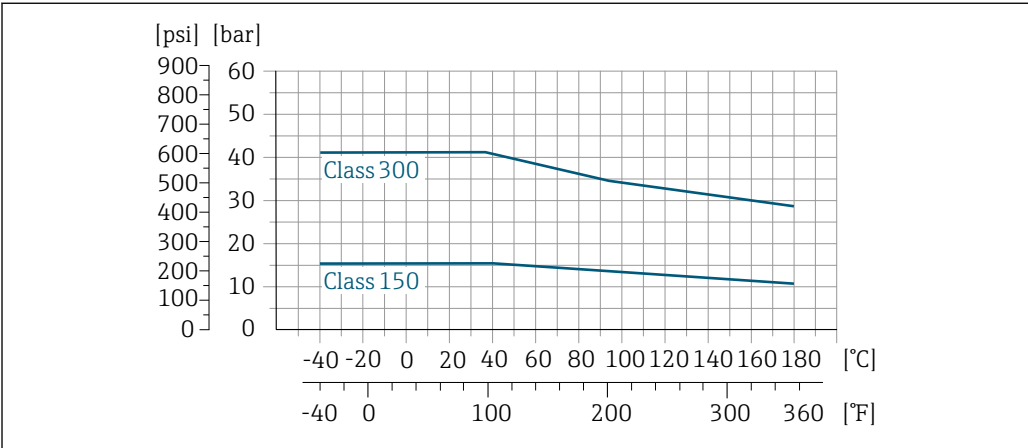

A0029394-EN

39 Process connection material: stainless steel, F316L

Process connection: flange according to JIS B2220

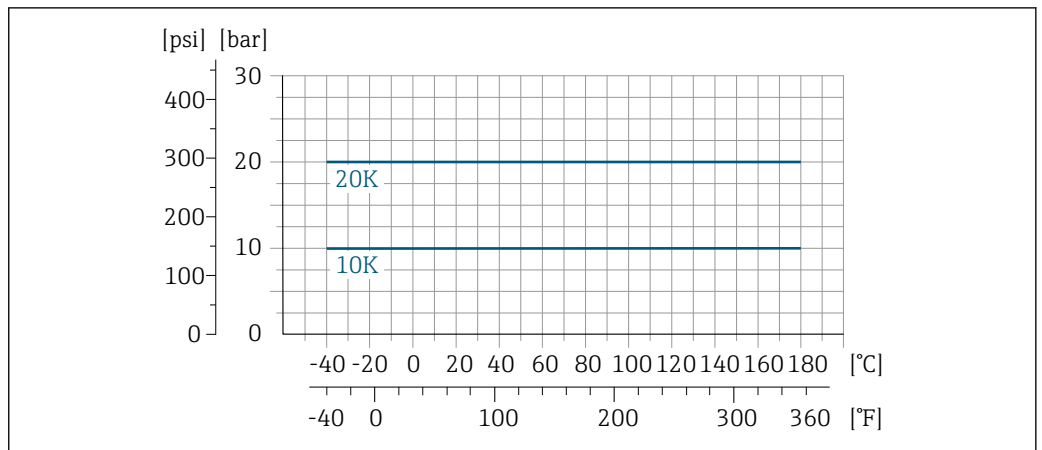

A0029397-EN

40 Process connection material: stainless steel, F316L; carbon steel, S235JRG2/HII

Process connection: flange according to AS 2129 (Table E) or AS 4087 (PN 16)

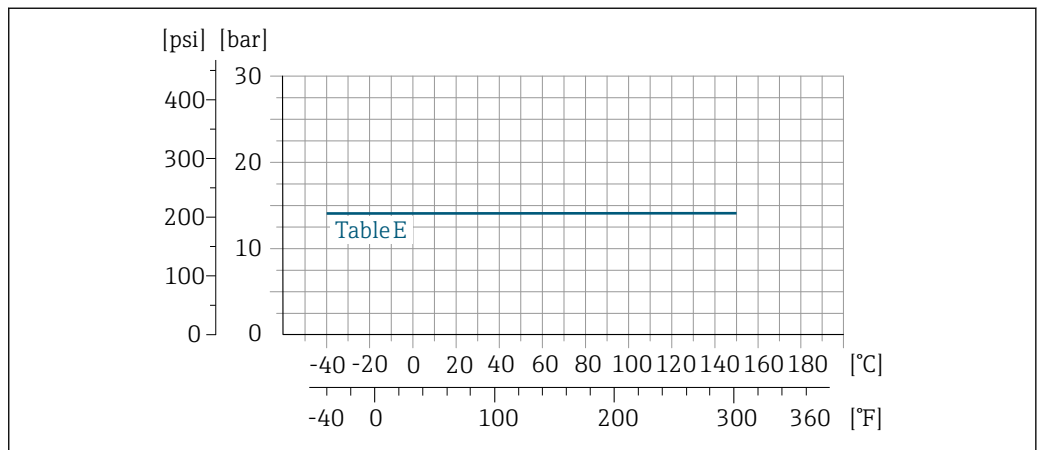

A0029398-EN

41 Process connection material: carbon steel, A105/S235JRG2/S275JR

Pressure tightness

Liner: PFA

Nominal diameter		Limit values for absolute pressure in [mbar] ([psi]) for medium temperatures:		
[mm]	[in]	+25 °C (+77 °F)	+80 °C (+176 °F)	+100 to +180 °C (+212 to +356 °F)
25	1	0 (0)	0 (0)	0 (0)
32	-	0 (0)	0 (0)	0 (0)
40	1 ½	0 (0)	0 (0)	0 (0)
50	2	0 (0)	0 (0)	0 (0)
65	-	0 (0)	0 (0)	0 (0)
80	3	0 (0)	0 (0)	0 (0)
100	4	0 (0)	0 (0)	0 (0)
125	-	0 (0)	0 (0)	0 (0)
150	6	0 (0)	0 (0)	0 (0)
200	8	0 (0)	0 (0)	0 (0)

Liner: PTFE

Nominal diameter		Limit values for absolute pressure in [mbar] ([psi]) for medium temperatures:			
[mm]	[in]	+25 °C (+77 °F)	+80 °C (+176 °F)	+100 °C (+212 °F)	+130 °C (+266 °F)
15	½	0 (0)	0 (0)	0 (0)	100 (1.45)
25	1	0 (0)	0 (0)	0 (0)	100 (1.45)
32	–	0 (0)	0 (0)	0 (0)	100 (1.45)
40	1 ½	0 (0)	0 (0)	0 (0)	100 (1.45)
50	2	0 (0)	0 (0)	0 (0)	100 (1.45)
65	–	0 (0)	–	40 (0.58)	130 (1.89)
80	3	0 (0)	–	40 (0.58)	130 (1.89)
100	4	0 (0)	–	135 (1.96)	170 (2.47)
125	–	135 (1.96)	–	240 (3.48)	385 (5.58)
150	6	135 (1.96)	–	240 (3.48)	385 (5.58)
200	8	200 (2.90)	–	290 (4.21)	410 (5.95)
250	10	330 (4.79)	–	400 (5.80)	530 (7.69)
300	12	400 (5.80)	–	500 (7.25)	630 (9.14)
350	14	470 (6.82)	–	600 (8.70)	730 (10.6)
400	16	540 (7.83)	–	670 (9.72)	800 (11.6)
450	18	No negative pressure permitted!			
500	20				
600	24				

Flow limit

The diameter of the pipe and the flow rate determine the nominal diameter of the sensor. The optimum velocity of flow is between 2 to 3 m/s (6.56 to 9.84 ft/s). Also match the velocity of flow (v) to the physical properties of the medium:

- v < 2 m/s (6.56 ft/s): for abrasive media (e.g. potter's clay, lime milk, ore slurry)
- v > 2 m/s (6.56 ft/s): for media producing buildup (e.g. wastewater sludge)



A necessary increase in the flow velocity can be achieved by reducing the sensor nominal diameter.



For an overview of the full scale values for the measuring range, see the "Measuring range" section

Pressure loss

- No pressure loss occurs if the sensor is installed in a pipe with the same nominal diameter.
- Pressure losses for configurations incorporating adapters according to DIN EN 545 → 65

System pressure

Installation near pumps → 61

Thermal insulation

If process fluids are very hot, it is necessary to insulate pipes in order to reduce energy loss and to prevent individuals from accidentally coming into contact with hot pipes. Please observe the applicable standards and guidelines for insulating pipes.



A housing support/an extended neck is used for heat dissipation:

- Devices with the order code for "Lining", option **B** "PFA high-temperature" always come with a housing support.
- In the case of all other devices, a housing support can be ordered via the order code for "Sensor option", option **CG** "Sensor extended neck".

**Electronics overheating on account of thermal insulation!**

- ▶ The housing support is used for heat dissipation and must be completely free (i.e. uncovered). At the very maximum, the sensor insulation may extend as far as the upper edge of the two sensor half-shells.

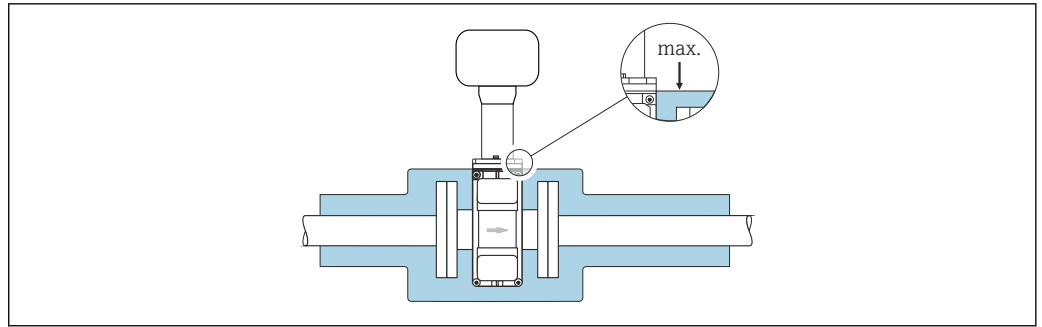

A0031216

Vibrations

Installation in event of pipe vibrations → 62

Magnetism and static electricity

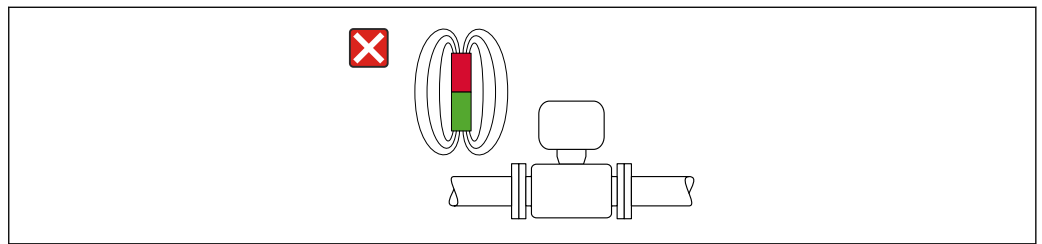

A0042152

42 Avoid magnetic fields

Custody transfer mode

The measuring device is optionally tested in accordance with OIML R49 and has an EU type-examination certificate according to Measuring Instruments Directive 2014/32/EU for service subject to legal metrological control ("custody transfer") for cold water (Annex III).

The permitted medium temperature in these applications is 0 to +50 °C (+32 to +122 °F).

The device is used with a legally controlled totalizer on the local display and optionally with legally controlled outputs.

Measuring devices subject to legal metrological control totalize in both directions, i.e. all the outputs consider flow components in the positive (forward) and negative (reverse) flow direction.

Generally a measuring device subject to legal metrological control is secured against tampering by seals on the transmitter or sensor. These seals may normally only be opened by a representative of the competent authority for legal metrology controls.

After putting the device into circulation or after sealing the device, operation is only possible to a limited extent.

Detailed ordering information is available from your local Endress+Hauser sales center for national approvals (outside Europe) as cold water meters based on OIML R49.

Mechanical construction

Dimensions in SI units

Housing of Proline 500 – digital transmitter

Non-hazardous area or hazardous area: Zone 2; Class I, Division 2

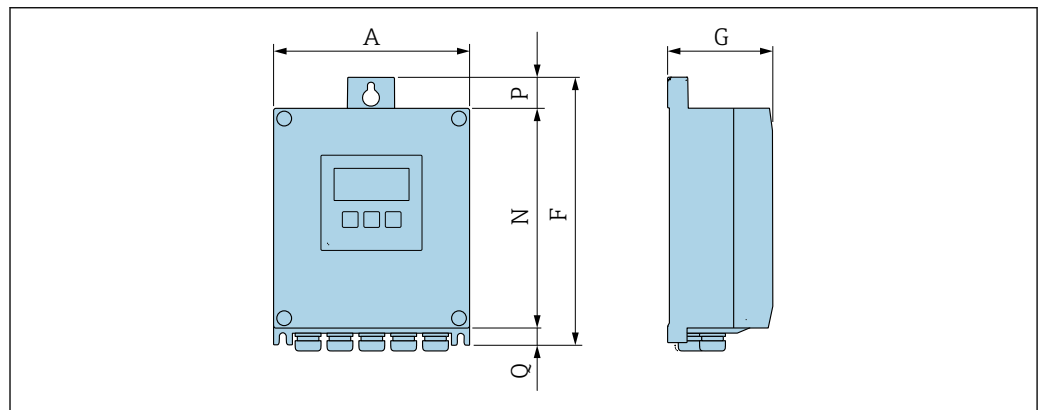

A0033789

Order code for "Transmitter housing", option A "Aluminum, coated" and order code for "Integrated ISEM electronics", option A "Sensor"

A [mm]	F [mm]	G [mm]	N [mm]	P [mm]	Q [mm]
167	232	89	187	24	21

Order code for "Transmitter housing", option D "Polycarbonate" and order code for "Integrated ISEM electronics", option A "Sensor"

A [mm]	F [mm]	G [mm]	N [mm]	P [mm]	Q [mm]
177	234	89	197	17	22

Housing of Proline 500 transmitter

Hazardous area: Zone 2; Class I, Division 2 or Zone 1; Class I, Division 1

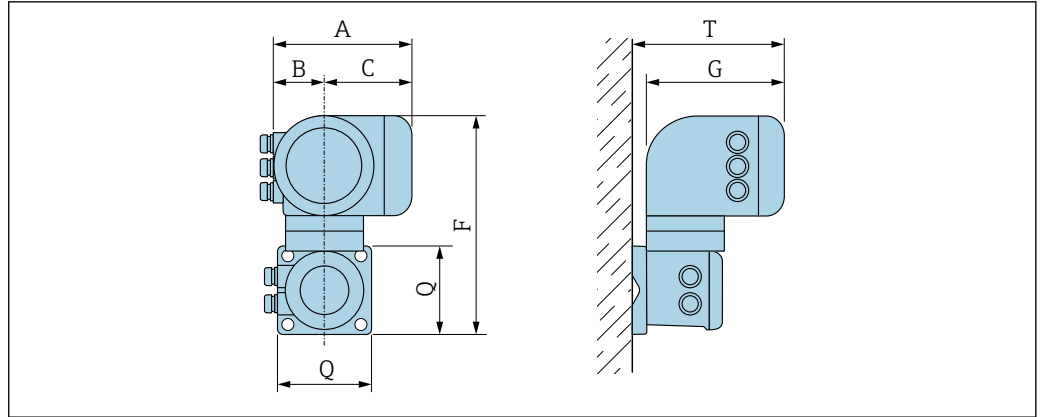

A0033788

Order code for "Transmitter housing", option A "Aluminum, coated" and order code for "Integrated ISEM electronics", option B "Transmitter"

A [mm]	B [mm]	C [mm]	F [mm]	G [mm]	Q [mm]	T [mm]
188	85	103	318	217	130	239

Order code for "Transmitter housing", option L "Cast, stainless" and order code for "Integrated ISEM electronics", option B "Transmitter"

A [mm]	B [mm]	C [mm]	F [mm]	G [mm]	Q [mm]	T [mm]
188	85	103	295	217	130	239

Sensor connection housing

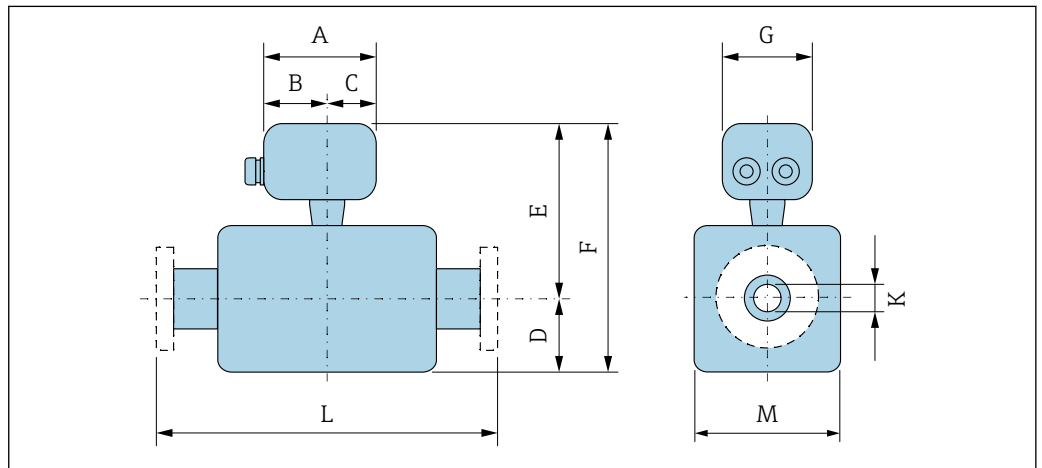

A0033784

Order code for "Sensor connection housing", option A "Aluminum, coated"

DN [mm]	A [mm]	B [mm]	C [mm]	D [mm]	E ¹⁾ [mm]	F ¹⁾ [mm]	G [mm]	K [mm]	L [mm]	M [mm]
15	148	94	54	84	197	281	136	²⁾	³⁾	120
25	148	94	54	84	197	281	136	²⁾	³⁾	120
32	148	94	54	84	197	281	136	²⁾	³⁾	120
40	148	94	54	84	197	281	136	²⁾	³⁾	120
50	148	94	54	84	197	281	136	²⁾	³⁾	120

DN [mm]	A [mm]	B [mm]	C [mm]	D [mm]	E ¹⁾ [mm]	F ¹⁾ [mm]	G [mm]	K [mm]	L [mm]	M [mm]
65	148	94	54	109	222	331	136	2)	3)	180
80	148	94	54	109	222	331	136	2)	3)	180
100	148	94	54	109	222	331	136	2)	3)	180
125	148	94	54	150	262	412	136	2)	3)	260
150	148	94	54	150	262	412	136	2)	3)	260
200	148	94	54	180	287	467	136	2)	3)	324
250	148	94	54	205	312	517	136	2)	3)	400
300	148	94	54	230	337	567	136	2)	3)	460
350	148	94	54	282	399	681	136	2)	3)	564
400	148	94	54	308	425	733	136	2)	3)	616
450	148	94	54	333	450	783	136	2)	3)	666
500	148	94	54	359	476	835	136	2)	3)	717
600	148	94	54	411	528	939	136	2)	3)	821

- 1) With order code for "Sensor option", option CG "Sensor extended neck for insulation" or order code for "Liner", option B "PFA high temperature": values + 110 mm
- 2) Depends on the liner → 96
- 3) Total installed length is independent of the process connections. Installed length according to DVGW (German Technical and Scientific Association for Gas and Water). → 81

Order code for "Sensor connection housing", option L "Cast, stainless"

DN [mm]	A [mm]	B [mm]	C [mm]	D [mm]	E [mm]	F [mm]	G [mm]	K [mm]	L [mm]	M [mm]
15	145	86	59	84	235	319	136	1)	2)	120
25	145	86	59	84	235	319	136	1)	2)	120
32	145	86	59	84	235	319	136	1)	2)	120
40	145	86	59	84	235	319	136	1)	2)	120
50	145	86	59	84	235	319	136	1)	2)	120
65	145	86	59	109	260	369	136	1)	2)	180
80	145	86	59	109	260	369	136	1)	2)	180
100	145	86	59	109	260	369	136	1)	2)	180
125	145	86	59	150	300	450	136	1)	2)	260
150	145	86	59	150	300	450	136	1)	2)	260
200	145	86	59	180	325	505	136	1)	2)	324
250	145	86	59	205	350	555	136	1)	2)	400
300	145	86	59	230	375	605	136	1)	2)	460
350	145	86	59	282	437	719	136	1)	2)	564
400	145	86	59	308	463	771	136	1)	2)	616
450	145	86	59	333	488	821	136	1)	2)	666
500	145	86	59	359	514	873	136	1)	2)	717
600	145	86	59	411	566	977	136	1)	2)	821

- 1) Depends on the liner → 96
- 2) Total installed length is independent of the process connections. Installed length according to DVGW (German Technical and Scientific Association for Gas and Water). → 81

Flange connections

Flange

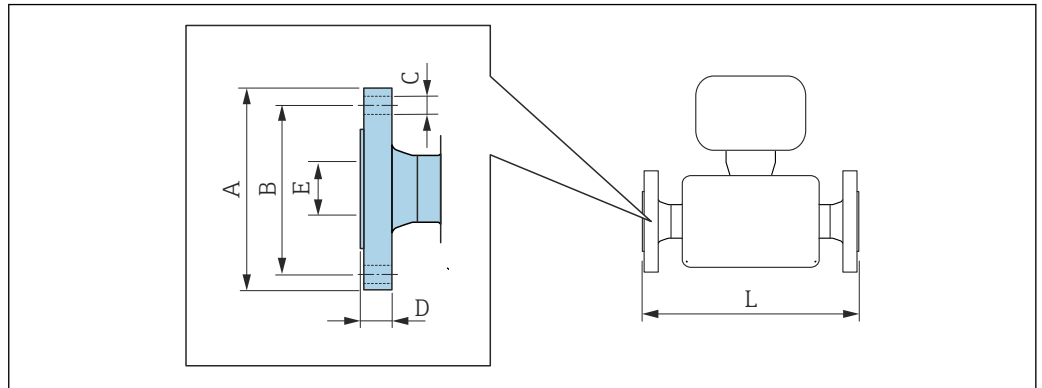

A0015621

Flange in accordance with EN 1092-1 (DIN 2501 / DIN 2512N): PN 10
P245GH (1.0352): Order code for "Process connection", option D2K
1.4404 (316L): Order code for "Process connection", option D2S

DN [mm]	A [mm]	B [mm]	C [mm]	D [mm]	E [mm]	L ¹⁾ [mm]
200	340	295	8 × Ø22	26	220.9	350
250	395	350	12 × Ø22	28	275.5	450
300	445	400	12 × Ø22	28	326.5	500
350	505	460	16 × Ø22	26	346	550
400	565	515	16 × Ø26	26	396	600
450	615	565	20 × Ø26	28	447	650
500	670	620	20 × Ø26	28	498	650
600	780	725	20 × Ø30	30	600	780

Surface roughness (flange): EN 1092-1 Form B1 (DIN 2526 Form C), Ra 6.3 to 12.5 µm

1) Installed length according to DVGW (German Technical and Scientific Association for Gas and Water).

Flange in accordance with EN 1092-1 (DIN 2501 / DIN 2512N): PN 16
P245GH (1.0352): Order code for "Process connection", option D3K
1.4404 (316L): Order code for "Process connection", option D3S

DN [mm]	A [mm]	B [mm]	C [mm]	D [mm]	E [mm]	L ¹⁾ [mm]
65	185	145	8 × Ø18	20	77.1	200
80	200	160	8 × Ø18	20	89.9	200
100	220	180	8 × Ø18	22	115.3	250
125	250	210	8 × Ø18	24	141.3	250
150	285	240	8 × Ø22	24	170.2	300
200	340	295	12 × Ø22	26	220.9	350
250	405	355	12 × Ø26	32	275.7	450
300	460	410	12 × Ø26	32	326.5	500
350	520	470	16 × Ø26	30	346	550
400	580	525	16 × Ø30	32	396	600
500	715	650	20 × Ø33	36	498	650

Flange in accordance with EN 1092-1 (DIN 2501 / DIN 2512N): PN 16						
P245GH (1.0352): Order code for "Process connection", option D3K						
1.4404 (316L): Order code for "Process connection", option D3S						
DN [mm]	A [mm]	B [mm]	C [mm]	D [mm]	E [mm]	L ¹⁾ [mm]
600	840	770	20 × Ø36	40	600	780
Surface roughness (flange): EN 1092-1 Form B1 (DIN 2526 Form C), Ra 6.3 to 12.5 µm						

1) Installed length according to DVGW (German Technical and Scientific Association for Gas and Water).

Flange in accordance with EN 1092-1 (DIN 2501 / DIN 2512N): PN 25						
P245GH (1.0352): Order code for "Process connection", option D4K						
1.4404 (316L): Order code for "Process connection", option D4S						
DN [mm]	A [mm]	B [mm]	C [mm]	D [mm]	E [mm]	L ¹⁾ [mm]
200	360	310	12 × Ø26	32	220.9	350
250	425	370	12 × Ø30	36	275.7	450
300	485	430	16 × Ø30	40	326.5	500
350	555	490	16 × Ø33	38	346	550
400	620	550	16 × Ø36	40	396	600
500	730	660	20 × Ø36	48	498	650
600	845	770	20 × Ø39	48	600	780
Surface roughness (flange): EN 1092-1 Form B1 (DIN 2526 Form C), Ra 6.3 to 12.5 µm						

1) Installed length according to DVGW (German Technical and Scientific Association for Gas and Water).

Flange in accordance with EN 1092-1 (DIN 2501 / DIN 2512N): PN 40						
P245GH (1.0352): Order code for "Process connection", option D5K						
1.4404 (316L): Order code for "Process connection", option D5S						
DN [mm]	A [mm]	B [mm]	C [mm]	D [mm]	E [mm]	L ¹⁾ [mm]
15	95	65	4 × Ø14	14	22.2	200
25	115	85	4 × Ø14	16	34.2	200
32	140	100	4 × Ø18	18	43	200
40	150	110	4 × Ø18	18	49.1	200
50	165	125	4 × Ø18	20	61.3	200
65	185	145	8 × Ø18	24	77.1	200
80	200	160	8 × Ø18	26	89.9	200
100	235	190	8 × Ø22	26	115.3	250
125	270	220	8 × Ø26	28	141.3	250
150	300	250	8 × Ø26	30	170.2	300
Surface roughness (flange): EN 1092-1 Form B1 (DIN 2526 Form C), Ra 6.3 to 12.5 µm						

1) Installed length according to DVGW (German Technical and Scientific Association for Gas and Water).

Flange according to ASME B16.5, Class 150						
A 105: Order code for "Process connection", option A1K						
1.4404 (316L): Order code for "Process connection", option A1S						
DN [mm]	A [mm]	B [mm]	C [mm]	D [mm]	E [mm]	L¹⁾ [mm]
15	88.9	60.5	4 × Ø16	9.6	22.3	200
25	108	79.2	4 × Ø16	12.6	34.2	200
40	127	98.6	4 × Ø16	15.9	49.1	200
50	152.4	120.7	4 × Ø19.1	17.5	61.3	200
80	190.5	152.4	4 × Ø19.1	22.3	89.9	200
100	228.6	190.5	8 × Ø19.1	22.3	115.3	250
150	279.4	241.3	8 × Ø22.4	23.8	170.2	300
200	342.9	298.5	8 × Ø22.4	26.8	220.9	350
250	406.4	362	12 × Ø25.4	29.6	275.7	450
300	482.6	431.8	12 × Ø25.4	30.2	326.5	500
350	535	476.3	12 × Ø28.6	35.4	346	550
400	595	539.8	16 × Ø28.6	37	396	600
450	635	577.9	16 × Ø31.8	40.1	447	650
500	700	635	20 × Ø31.8	43.3	498	650
600	815	749.3	20 × Ø34.9	48.1	600	780
Surface roughness (flange): Ra 6.3 to 12.5 µm						

1) Installed length according to DVGW (German Technical and Scientific Association for Gas and Water).

Flange according to ASME B16.5, Class 300						
A 105: Order code for "Process connection", option A2K						
1.4404 (316L): Order code for "Process connection", option A2S						
DN [mm]	A [mm]	B [mm]	C [mm]	D [mm]	E [mm]	L¹⁾ [mm]
15	95.3	66.5	4 × Ø16	12.6	22.3	200
25	123.9	88.9	4 × Ø19.1	15.9	34.2	200
40	155.4	114.3	4 × Ø22.4	19	49.1	200
50	165.1	127	8 × Ø19.1	20.8	61.3	200
80	209.6	168.1	8 × Ø22.4	26.8	89.9	200
100	254	200.2	8 × Ø22.4	30.2	115.3	250
150	317.5	269.7	12 × Ø22.4	35	170.2	300
Surface roughness (flange): Ra 6.3 to 12.5 µm						

1) Installed length according to DVGW (German Technical and Scientific Association for Gas and Water).

Flange according to JIS B2220, 10K						
A 105/A350LF2: Order code for "Process connection", option N3K						
1.4404 (316L): Order code for "Process connection", option N3S						
DN [mm]	A [mm]	B [mm]	C [mm]	D [mm]	E [mm]	L¹⁾ [mm]
50	155	120	4 × Ø19	16	61.1	200
65	175	140	4 × Ø19	18	77.1	200
80	185	150	8 × Ø19	18	90	200

Flange according to JIS B2220, 10K						
A 105/A350LF2: Order code for "Process connection", option N3K						
1.4404 (316L): Order code for "Process connection", option N3S						
DN [mm]	A [mm]	B [mm]	C [mm]	D [mm]	E [mm]	L¹⁾ [mm]
100	210	175	8 × Ø19	18	115.4	250
125	250	210	8 × Ø23	20	141.2	250
150	280	240	8 × Ø23	22	169	300
200	330	290	12 × Ø23	22	220	350
250	400	355	12 × Ø25	24	274	450
300	445	400	16 × Ø25	24	325	500
Surface roughness (flange): Ra 6.3 to 12.5 µm						

1) Installed length according to DVGW (German Technical and Scientific Association for Gas and Water).

Flange according to JIS B2220, 20K						
A 105/A350LF2: Order code for "Process connection", option N4K						
1.4404 (316L): Order code for "Process connection", option N4S						
DN [mm]	A [mm]	B [mm]	C [mm]	D [mm]	E [mm]	L¹⁾ [mm]
15	95	70	4 × Ø15	14	22.2	200
25	125	90	4 × Ø19	16	34.5	200
32	135	100	4 × Ø19	18	43.2	200
40	140	105	4 × Ø19	18	49.1	200
50	155	120	8 × Ø19	18	61.1	200
65	175	140	8 × Ø19	20	77.1	200
80	200	160	8 × Ø23	22	90	200
100	225	185	8 × Ø23	24	115.4	250
125	270	225	8 × Ø25	26	141.2	250
150	305	260	12 × Ø25	28	169	300
200	350	305	12 × Ø25	30	220	350
250	430	380	12 × Ø27	34	274	450
300	480	430	16 × Ø27	36	325	500
Surface roughness (flange): Ra 6.3 to 12.5 µm						

1) Installed length according to DVGW (German Technical and Scientific Association for Gas and Water).

Accessories

Weather protection cover

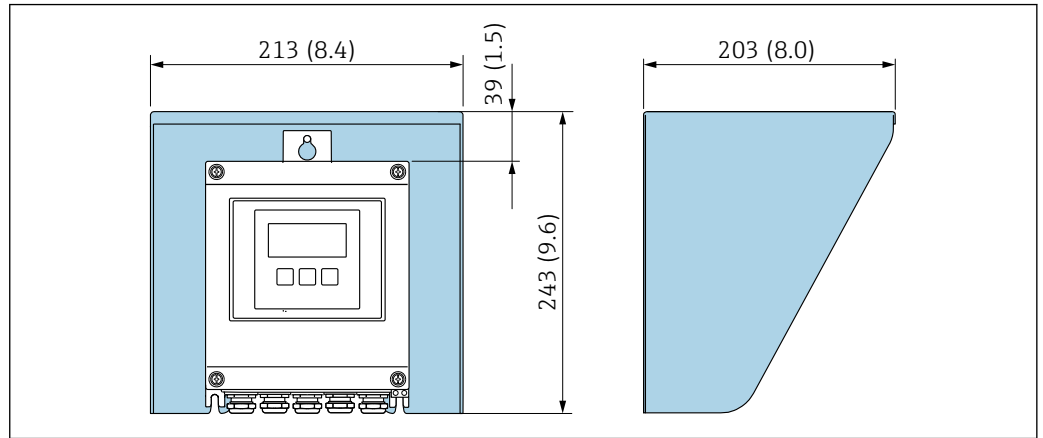

A0029552

43 Weather protection cover for Proline 500 – digital; engineering unit mm (in)

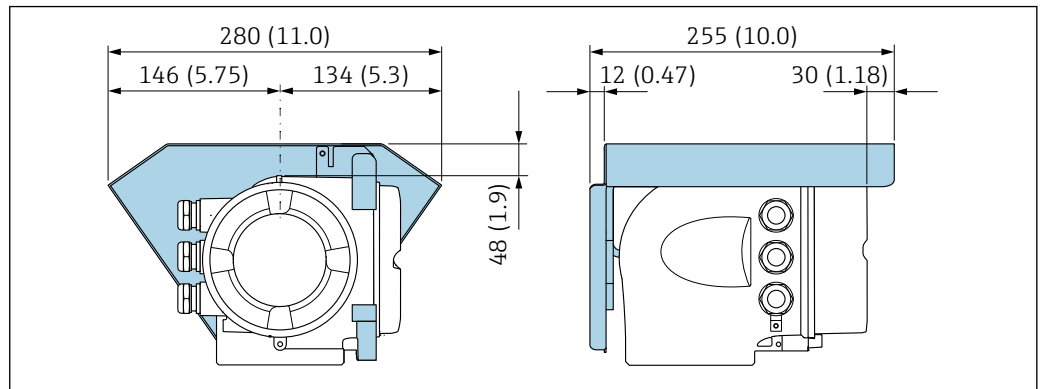

A0029553

44 Weather protection cover for Proline 500; engineering unit mm (in)

External WLAN antenna

i The external WLAN antenna is not suitable for use in hygienic applications.

Proline 500 – digital

External WLAN antenna mounted on device

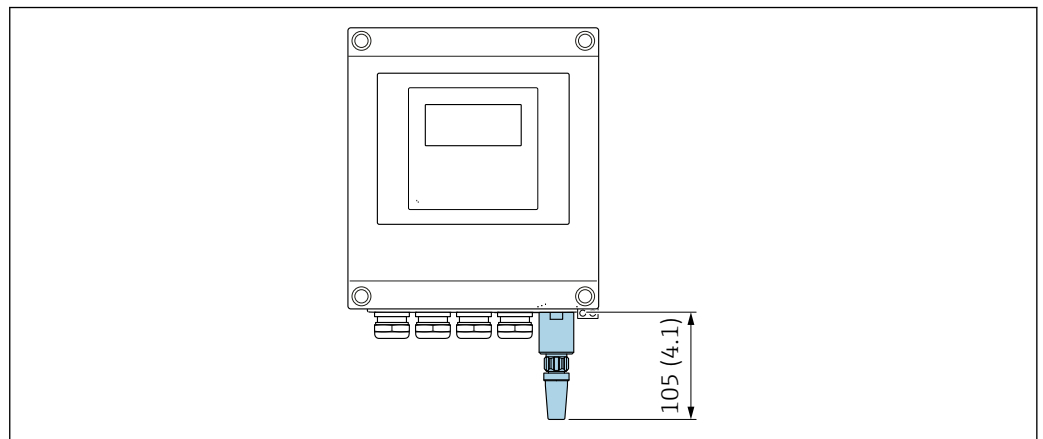

A0033607

45 Engineering unit mm (in)

External WLAN antenna mounted with cable

The external WLAN antenna can be mounted separately from the transmitter if the transmission/reception conditions at the transmitter mounting location are poor.

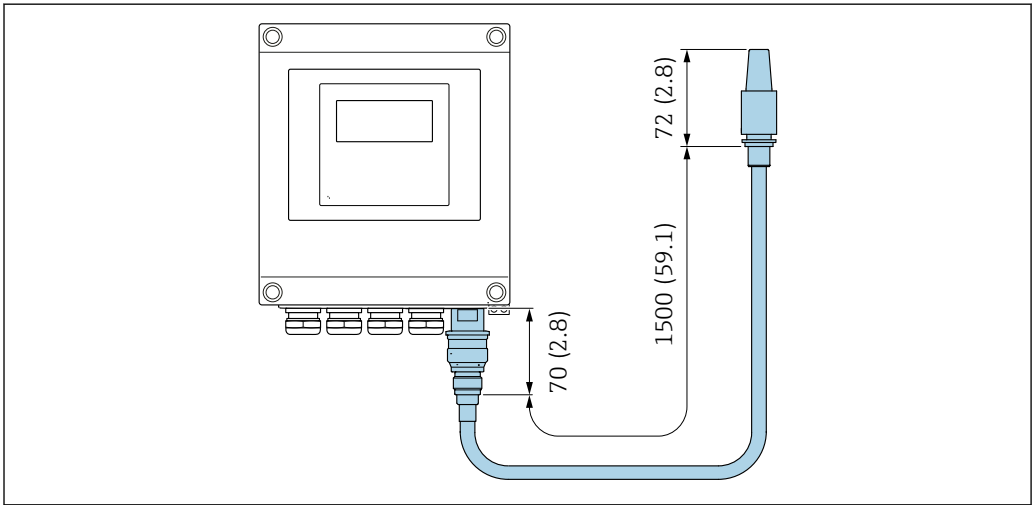

46 Engineering unit mm (in)

Proline 500

External WLAN antenna mounted on device

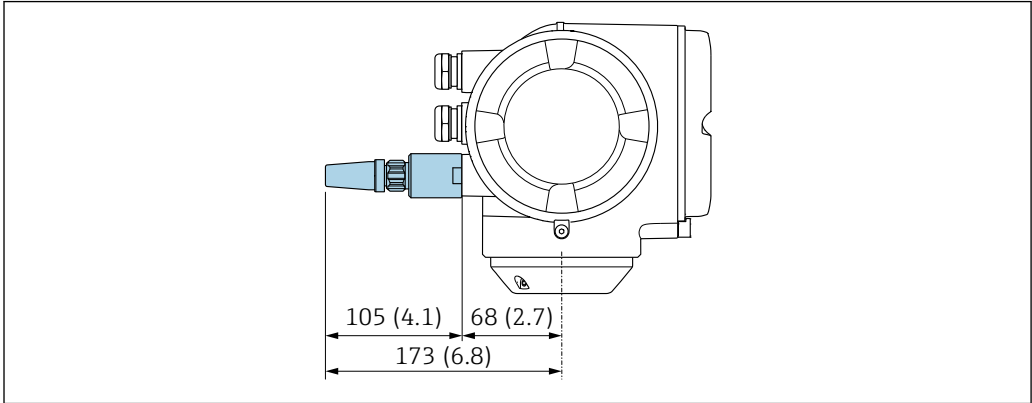

47 Engineering unit mm (in)

External WLAN antenna mounted with cable

The external WLAN antenna can be mounted separately from the transmitter if the transmission/reception conditions at the transmitter mounting location are poor.

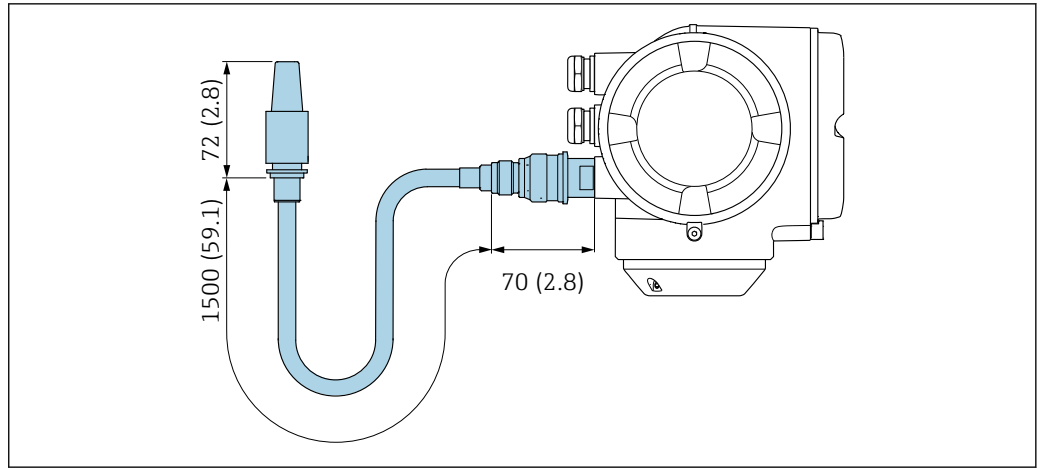

A0033597

48 Engineering unit mm (in)

Ground disk for flange connection

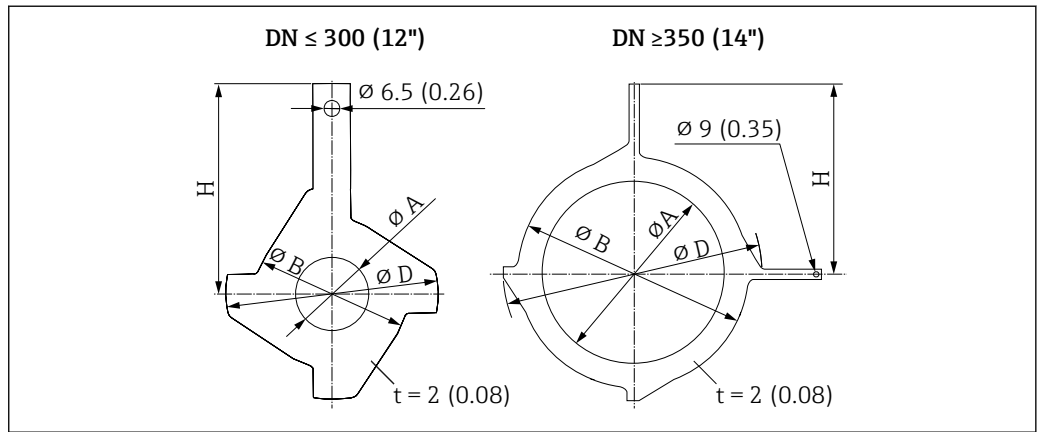

A0042090

DN ¹⁾ EN (DIN), JIS, AS ²⁾ [mm]	A PFA, PTFE [mm]	B [mm]	D [mm]	H [mm]
15	16	43	61.5	73
25	26	62	77.5	87.5
32	35	80	87.5	94.5
40	41	82	101	103
50	52	101	115.5	108
65	68	121	131.5	118
80	80	131	154.5	135
100	104	156	186.5	153
125	130	187	206.5	160
150	158	217	256	184
200	206	267	288	205
250	260	328	359	240
300 ³⁾	312	375	413	273
300 ⁴⁾	310	375	404	268
350 ³⁾	420	433	479	365

DN ¹⁾ EN (DIN), JIS, AS ²⁾ [mm]	A PFA, PTFE [mm]	B [mm]	D [mm]	H [mm]
400 ³⁾	470	480	542	395
450 ³⁾	525	538	583	417
500 ³⁾	575	592	650	460
600 ³⁾	676	693	766	522

- 1) Ground disks DN 15 to 250 (½ to 10") can be used for all available flange standards/pressure ratings.
- 2) For flanges according to AS, only DN 25 and DN 50 are available.
- 3) PN 10/16
- 4) PN 25, JIS 10K/20K

Dimensions in US units

Housing of Proline 500 – digital transmitter

Non-hazardous area or hazardous area: Zone 2; Class I, Division 2

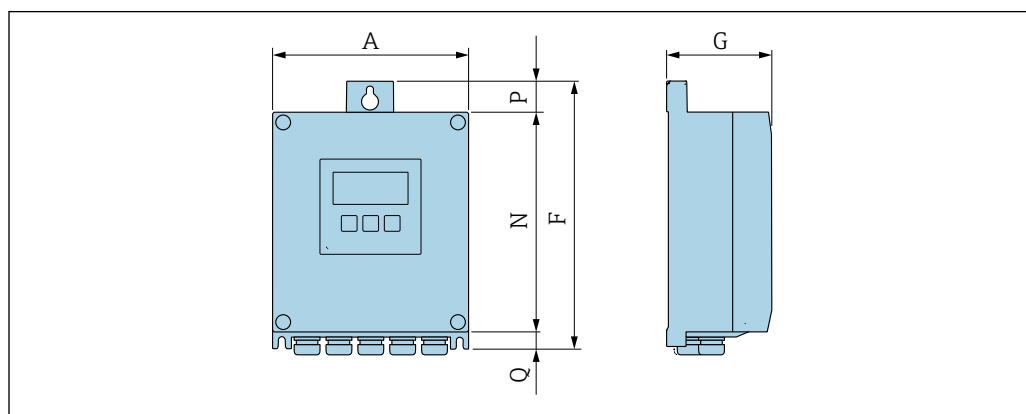

A0033789

Order code for "Transmitter housing", option A "Aluminum, coated" and order code for "Integrated ISEM electronics", option A "Sensor"

A [in]	F [in]	G [in]	N [in]	P [in]	Q [in]
6.57	9.13	3.50	7.36	0.94	0.83

Order code for "Transmitter housing", option D "Polycarbonate" and order code for "Integrated ISEM electronics", option A "Sensor"

A [in]	F [in]	G [in]	N [in]	P [in]	Q [in]
6.97	9.21	3.50	7.76	0.67	0.87

Housing of Proline 500 transmitter

Hazardous area: Zone 2; Class I, Division 2 or Zone 1; Class I, Division 1

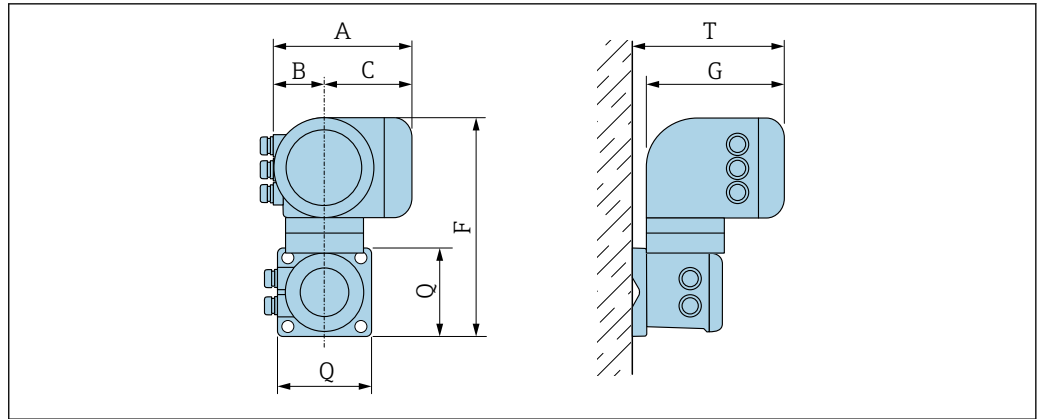

A0033788

Order code for "Transmitter housing", option A "Aluminum, coated" and order code for "Integrated ISEM electronics", option B "Transmitter"

A [in]	B [in]	C [in]	F [in]	G [in]	Q [in]	T [in]
7.40	3.35	4.06	12.5	8.54	5.12	9.41

Order code for "Transmitter housing", option L "Cast, stainless" and order code for "Integrated ISEM electronics", option B "Transmitter"

A [in]	B [in]	C [in]	F [in]	G [in]	Q [in]	T [in]
7.40	3.35	4.06	11.6	8.54	5.12	9.41

Sensor connection housing

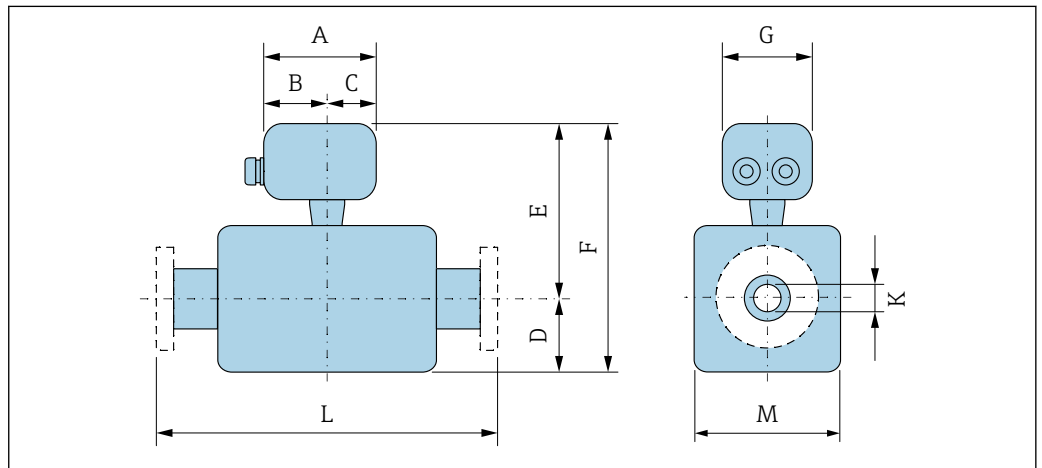

A0033784

Order code for "Sensor connection housing", option A "Aluminum, coated"

DN [in]	A [in]	B [in]	C [in]	D [in]	E ¹⁾ [in]	F ¹⁾ [in]	G [in]	K [in]	L [in]	M [in]
½	5.83	3.70	2.13	3.31	7.76	11.06	5.35	2)	3)	4.72
1	5.83	3.70	2.13	3.31	7.76	11.06	5.35	2)	3)	4.72
1 ¼	5.83	3.70	2.13	3.31	7.76	11.06	5.35	2)	3)	4.72
1 ½	5.83	3.70	2.13	3.31	7.76	11.06	5.35	2)	3)	4.72
2	5.83	3.70	2.13	3.31	7.76	11.06	5.35	2)	3)	4.72

DN [in]	A [in]	B [in]	C [in]	D [in]	E ¹⁾ [in]	F ¹⁾ [in]	G [in]	K [in]	L [in]	M [in]
2 ½	5.83	3.70	2.13	4.29	8.74	13.03	5.35	2)	3)	7.09
3	5.83	3.70	2.13	4.29	8.74	13.03	5.35	2)	3)	7.09
4	5.83	3.70	2.13	4.29	8.74	13.03	5.35	2)	3)	7.09
5	5.83	3.70	2.13	5.91	10.31	16.22	5.35	2)	3)	10.2
6	5.83	3.70	2.13	5.91	10.31	16.22	5.35	2)	3)	10.2
8	5.83	3.70	2.13	7.09	11.3	18.39	5.35	2)	3)	12.8
10	5.83	3.70	2.13	8.07	12.28	20.35	5.35	2)	3)	15.8
12	5.83	3.70	2.13	9.06	13.27	22.32	5.35	2)	3)	18.1
14	5.83	3.70	2.13	11.1	15.71	26.81	5.35	2)	3)	22.2
16	5.83	3.70	2.13	12.13	16.73	28.86	5.35	2)	3)	24.3
18	5.83	3.70	2.13	13.11	17.72	30.83	5.35	2)	3)	26.2
20	5.83	3.70	2.13	14.13	18.74	32.87	5.35	2)	3)	28.2
24	5.83	3.70	2.13	16.18	20.79	36.97	5.35	2)	3)	32.3

- 1) With order code for "Sensor option", option CG "Sensor extended neck for insulation" or order code for "Liner", option B "PFA high temperature": values + 4.33 in
- 2) Depends on the liner → 96
- 3) Total installed length is independent of the process connections. Installed length according to DVGW (German Technical and Scientific Association for Gas and Water). → 91

Order code for "Sensor connection housing", option L "Cast, stainless"

DN [in]	A [in]	B [in]	C [in]	D [in]	E [in]	F [in]	G [in]	K [in]	L [in]	M [in]
½	5.71	3.39	2.32	3.31	9.25	12.56	5.35	1)	2)	4.72
1	5.71	3.39	2.32	3.31	9.25	12.56	5.35	1)	2)	4.72
1 ¼	5.71	3.39	2.32	3.31	9.25	12.56	5.35	1)	2)	4.72
1 ½	5.71	3.39	2.32	3.31	9.25	12.56	5.35	1)	2)	4.72
2	5.71	3.39	2.32	3.31	9.25	12.56	5.35	1)	2)	4.72
2 ½	5.71	3.39	2.32	4.29	10.24	14.53	5.35	1)	2)	7.09
3	5.71	3.39	2.32	4.29	10.24	14.53	5.35	1)	2)	7.09
4	5.71	3.39	2.32	4.29	10.24	14.53	5.35	1)	2)	7.09
5	5.71	3.39	2.32	5.91	11.81	17.72	5.35	1)	2)	10.2
6	5.71	3.39	2.32	5.91	11.81	17.72	5.35	1)	2)	10.2
8	5.71	3.39	2.32	7.09	12.8	19.88	5.35	1)	2)	12.8
10	5.71	3.39	2.32	8.07	13.78	21.85	5.35	1)	2)	15.8
12	5.71	3.39	2.32	9.06	14.76	23.82	5.35	1)	2)	18.1
14	5.71	3.39	2.32	11.1	17.2	28.31	5.35	1)	2)	22.2
16	5.71	3.39	2.32	12.13	18.23	30.35	5.35	1)	2)	24.3
18	5.71	3.39	2.32	13.11	19.21	32.32	5.35	1)	2)	26.2
20	5.71	3.39	2.32	14.13	20.24	34.37	5.35	1)	2)	28.2
24	5.71	3.39	2.32	16.18	22.28	38.46	5.35	1)	2)	32.3

- 1) Depends on the liner → 96
- 2) Total installed length is independent of the process connections. Installed length according to DVGW (German Technical and Scientific Association for Gas and Water). → 91

Flange connections

Flange

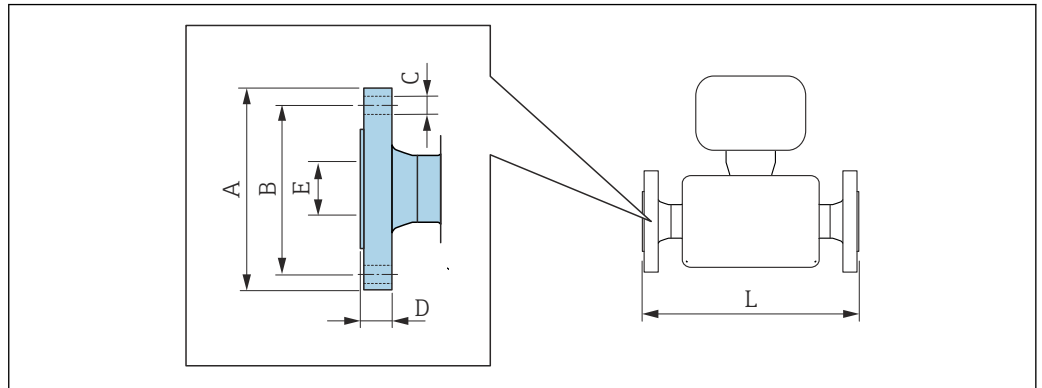

A0015621

Flange according to ASME B16.5, Class 150

A 105: Order code for "Process connection", option A1K

1.4404 (316L): Order code for "Process connection", option A1S

DN [in]	A [in]	B [in]	C [in]	D [in]	E [in]	L ¹⁾ [in]
½	3.5	2.38	4 × Ø0.63	0.38	0.88	7.87
1	4.25	3.12	4 × Ø0.63	0.5	1.35	7.87
1 ½	5	3.88	4 × Ø0.63	0.63	1.93	7.87
2	6	4.75	4 × Ø0.75	0.69	2.41	7.87
3	7.5	6	4 × Ø0.75	0.88	3.54	7.87
4	9	7.5	8 × Ø0.75	0.88	4.54	9.84
6	11	9.5	8 × Ø0.88	0.94	6.7	11.8
8	13.5	11.75	8 × Ø0.88	1.06	8.7	13.8
10	16	14.25	12 × Ø1	1.17	10.85	17.7
12	19	17	12 × Ø1	1.19	12.85	19.7
14	21.06	18.75	12 × Ø1.13	1.39	13.62	21.7
16	23.43	21.25	16 × Ø1.13	1.46	15.59	23.6
18	25	22.75	16 × Ø1.25	1.58	17.6	25.6
20	27.56	25	20 × Ø1.25	1.7	19.61	25.6
24	32.09	29.5	20 × Ø1.37	1.89	23.62	30.7

Surface roughness (flange): Ra 6.3 to 12.5 µm

1) Installed length according to DVGW (German Technical and Scientific Association for Gas and Water).

Flange according to ASME B16.5, Class 300

A 105: Order code for "Process connection", option A2K

1.4404 (316L): Order code for "Process connection", option A2S

DN [in]	A [in]	B [in]	C [in]	D [in]	E [in]	L ¹⁾ [in]
½	3.75	2.62	4 × Ø0.63	0.5	0.88	7.87
1	4.88	3.5	4 × Ø0.75	0.63	1.35	7.87
1 ½	6.12	4.5	4 × Ø0.88	0.75	1.93	7.87
2	6.5	5	8 × Ø0.75	0.82	2.41	7.87

Flange according to ASME B16.5, Class 300

A 105: Order code for "Process connection", option A2K

1.4404 (316L): Order code for "Process connection", option A2S

DN [in]	A [in]	B [in]	C [in]	D [in]	E [in]	L ¹⁾ [in]
3	8.25	6.62	8 × Ø0.88	1.06	3.54	7.87
4	10	7.88	8 × Ø0.88	1.19	4.54	9.84
6	12.5	10.62	12 × Ø0.88	1.38	6.7	11.8

Surface roughness (flange): Ra 6.3 to 12.5 µm

1) Installed length according to DVGW (German Technical and Scientific Association for Gas and Water).

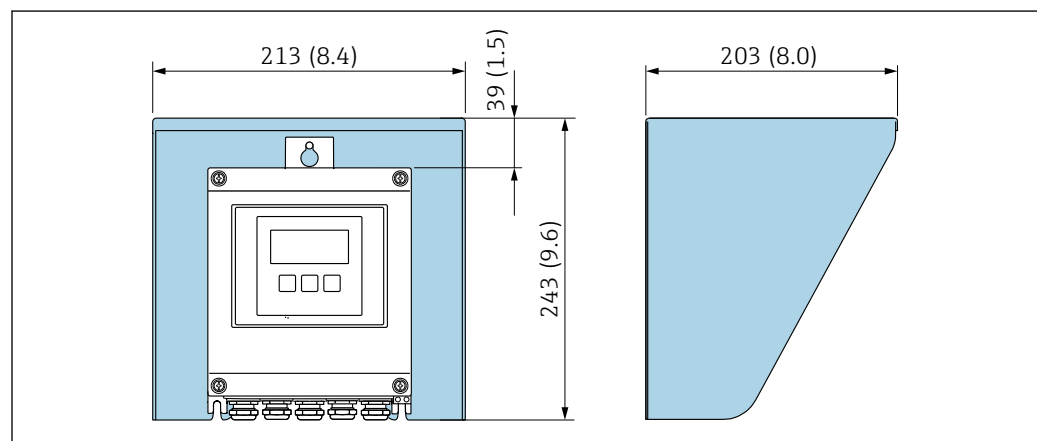
Accessories*Weather protection cover*

A0029552

49 Weather protection cover for Proline 500 – digital; engineering unit mm (in)

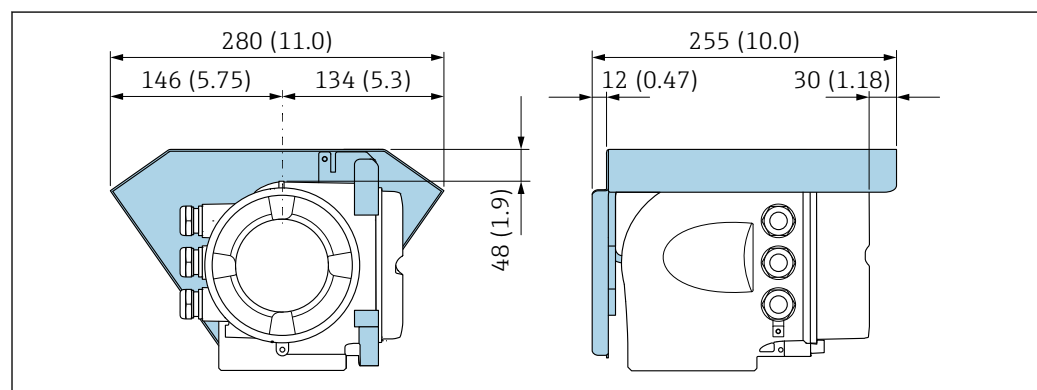

A0029553

50 Weather protection cover for Proline 500; engineering unit mm (in)

External WLAN antenna

i The external WLAN antenna is not suitable for use in hygienic applications.

Proline 500 – digital

External WLAN antenna mounted on device

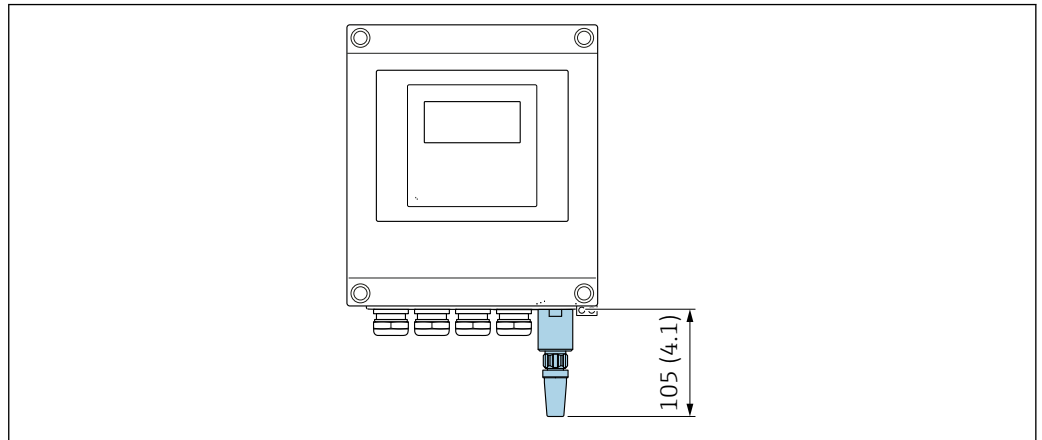

51 Engineering unit mm (in)

External WLAN antenna mounted with cable

The external WLAN antenna can be mounted separately from the transmitter if the transmission/reception conditions at the transmitter mounting location are poor.

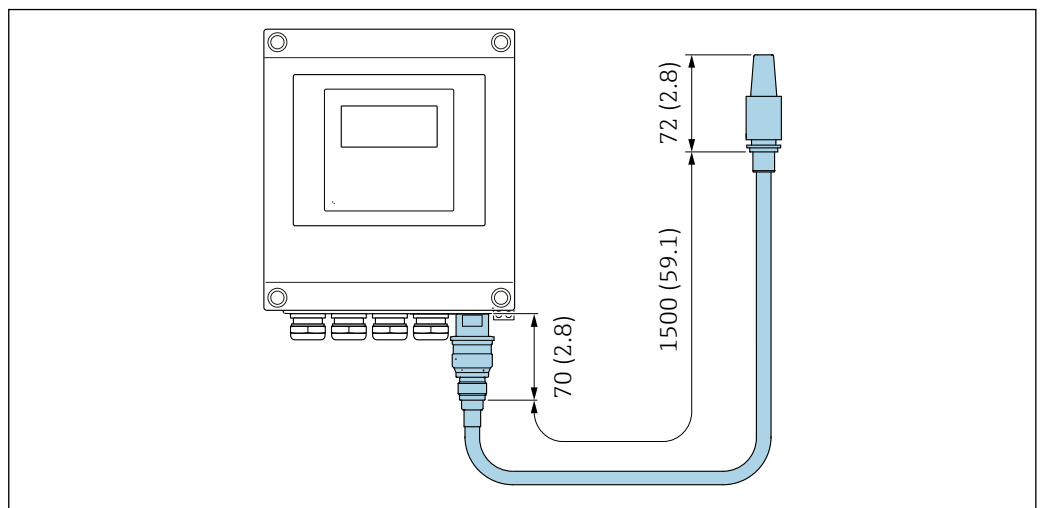

52 Engineering unit mm (in)

Proline 500

External WLAN antenna mounted on device

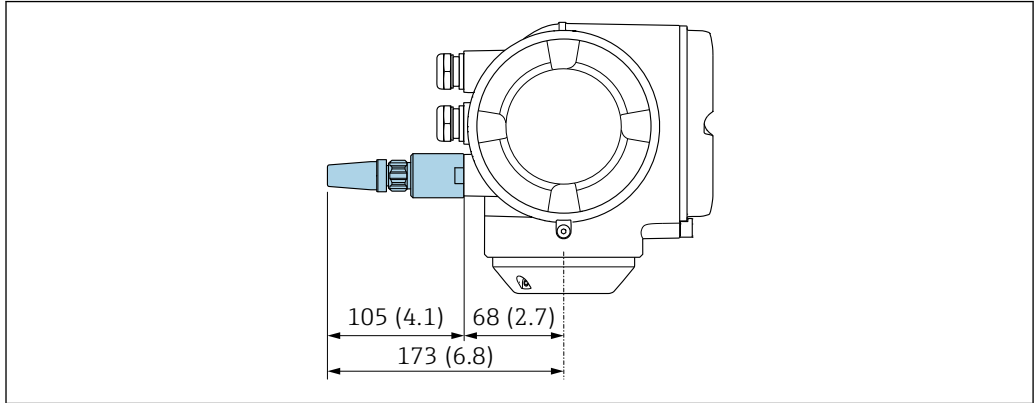

53 Engineering unit mm (in)

A0028923

External WLAN antenna mounted with cable

The external WLAN antenna can be mounted separately from the transmitter if the transmission/reception conditions at the transmitter mounting location are poor.

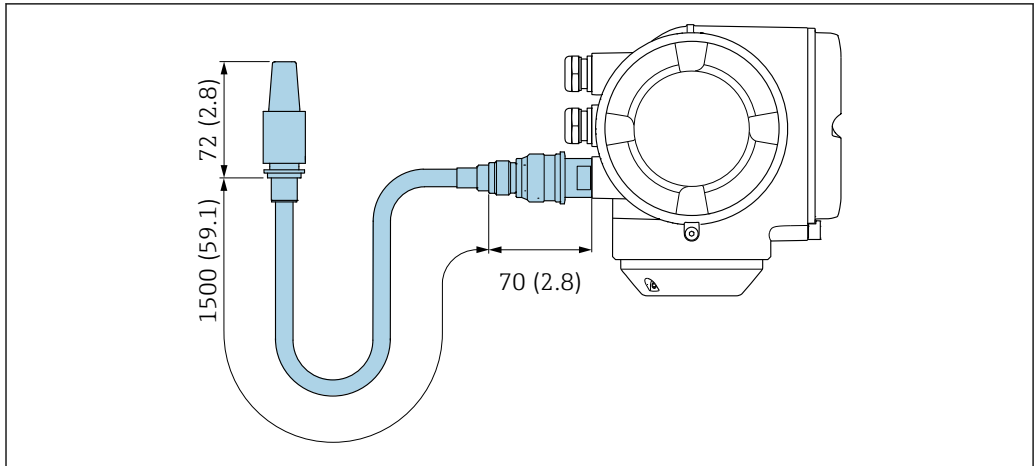

54 Engineering unit mm (in)

A0033597

Ground disk for flange connection

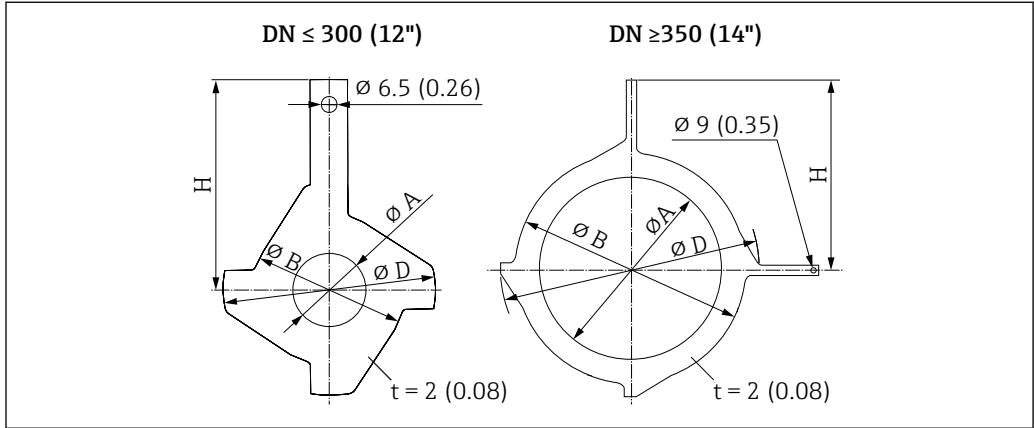

A0042090

DN ¹⁾ ASME [in]	A PFA, PTFE [in]	B [in]	D [in]	H [in]
½	0.63	1.69	2.42	2.87
1	1.02	2.44	3.05	3.44
1 ½	1.61	3.23	3.98	4.06
2	2.05	3.98	4.55	4.25
3	3.15	5.16	6.08	5.31
4	4.09	6.14	7.34	6.02
6	6.22	8.54	10.08	7.24
8	8.11	10.51	11.34	8.07
10	10.24	12.91	14.13	9.45
12	12.28	14.76	16.26	10.75
14	16.50	17.05	18.86	14.37
16	18.50	18.90	21.34	15.55
18	20.67	21.18	22.95	16.42
20	22.64	23.31	25.59	18.11
24	26.61	27.28	30.16	20.55

1) Ground disks can be used for all available pressure ratings.

Weight

All values (weight exclusive of packaging material) refer to devices with flanges of the standard pressure rating.

The weight may be lower than indicated depending on the pressure rating and design.

Transmitter

- Proline 500 – digital polycarbonate: 1.4 kg (3.1 lbs)
- Proline 500 – digital aluminum: 2.4 kg (5.3 lbs)
- Proline 500 aluminum: 6.5 kg (14.3 lbs)
- Proline 500 cast, stainless: 15.6 kg (34.4 lbs)

Sensor

- Sensor with cast connection housing version, stainless: +3.7 kg (+8.2 lbs)
- Sensor with aluminum connection housing version:

Weight in SI units

Nominal diameter		EN (DIN), AS ¹⁾		ASME		JIS	
[mm]	[in]	Pressure rating	[kg]	Pressure rating	[kg]	Pressure rating	[kg]
15	½	PN 40	4.5	Class 150	4.5	10K	4.5
25	1	PN 40	5.3	Class 150	5.3	10K	5.3
32	–	PN 40	6	Class 150	–	10K	5.3
40	1 ½	PN 40	7.4	Class 150	7.4	10K	6.3
50	2	PN 40	8.6	Class 150	8.6	10K	7.3
65	–	PN 16	10	Class 150	–	10K	9.1
80	3	PN 16	12	Class 150	12	10K	10.5
100	4	PN 16	14	Class 150	14	10K	12.7
125	–	PN 16	19.5	Class 150	–	10K	19
150	6	PN 16	23.5	Class 150	23.5	10K	22.5
200	8	PN 10	43	Class 150	43	10K	39.9
250	10	PN 10	63	Class 150	73	10K	67.4

Nominal diameter		EN (DIN), AS ¹⁾		ASME		JIS	
[mm]	[in]	Pressure rating	[kg]	Pressure rating	[kg]	Pressure rating	[kg]
300	12	PN 10	68	Class 150	108	10K	70.3
350	14	PN 10	103	Class 150	173	10K	79
400	16	PN 10	118	Class 150	203	10K	100
450	18	PN 10	159	Class 150	253	10K	128
500	20	PN 10	154	Class 150	283	10K	142
600	24	PN 10	206	Class 150	403	10K	188

1) For flanges according to AS, only DN 25 and 50 are available.

Weight in US units

Nominal diameter		ASME	
[mm]	[in]	Pressure rating	[lbs]
15	½	Class 150	9.92
25	1	Class 150	11.7
40	1 ½	Class 150	16.3
50	2	Class 150	19.0
80	3	Class 150	26.5
100	4	Class 150	30.9
150	6	Class 150	51.8
200	8	Class 150	94.8
250	10	Class 150	161.0
300	12	Class 150	238.1
350	14	Class 150	381.5
400	16	Class 150	447.6
450	18	Class 150	557.9
500	20	Class 150	624.0
600	24	Class 150	888.6

Measuring tube specification

Nominal diameter		Pressure rating					Process connection internal diameter			
		EN (DIN)	ASME	AS 2129	AS 4087	JIS	PFA		PTFE	
[mm]	[in]	[bar]	[psi]	[bar]	[bar]	[bar]	[mm]	[in]	[mm]	[in]
15	½	PN 40	Class 150	-	-	20K	-	-	15	0.59
25	1	PN 40	Class 150	Table E	-	20K	23	0.91	26	1.02
32	-	PN 40	-	-	-	20K	32	1.26	35	1.38
40	1 ½	PN 40	Class 150	-	-	20K	36	1.42	41	1.61
50	2	PN 40	Class 150	Table E	PN 16	10K	48	1.89	52	2.05
65	-	PN 16	-	-	-	10K	63	2.48	67	2.64
80	3	PN 16	Class 150	-	-	10K	75	2.95	80	3.15
100	4	PN 16	Class 150	-	-	10K	101	3.98	104	4.09
125	-	PN 16	-	-	-	10K	126	4.96	129	5.08
150	6	PN 16	Class 150	-	-	10K	154	6.06	156	6.14

Nominal diameter		Pressure rating					Process connection internal diameter			
		EN (DIN)	ASME	AS 2129	AS 4087	JIS	PFA		PTFE	
[mm]	[in]	[bar]	[psi]	[bar]	[bar]	[bar]	[mm]	[in]	[mm]	[in]
200	8	PN 10	Class 150	–	–	10K	201	7.91	202	7.95
250	10	PN 10	Class 150	–	–	10K	–	–	256	10.1
300	12	PN 10	Class 150	–	–	10K	–	–	306	12.0
350	14	PN 10	Class 150	–	–	10K	–	–	337	13.3
400	16	PN 10	Class 150	–	–	10K	–	–	387	15.2
450	18	PN 10	Class 150	–	–	10K	–	–	432	17.0
500	20	PN 10	Class 150	–	–	10K	–	–	487	19.2
600	24	PN 10	Class 150	–	–	10K	–	–	593	23.3

Materials

Transmitter housing

Housing of Proline 500 – digital transmitter

Order code for "Transmitter housing":

- Option **A** "Aluminum coated": aluminum, AlSi10Mg, coated
- Option **D** "Polycarbonate": polycarbonate

Housing of Proline 500 transmitter

Order code for "Transmitter housing":

- Option **A** "Aluminum coated": aluminum, AlSi10Mg, coated
- Option **L** "Cast, stainless": cast, stainless steel, 1.4409 (CF3M) similar to 316L

Window material

Order code for "Transmitter housing":

- Option **A** "Aluminum, coated": glass
- Option **D** "Polycarbonate": plastic
- Option **L** "Cast, stainless": glass

Fastening components for mounting on a post

- Screws, threaded bolts, washers, nuts: stainless A2 (chrome-nickel steel)
- Metal plates: stainless steel, 1.4301 (304)

Sensor connection housing

Order code for "Sensor connection housing":

- Option **A** "Aluminum coated": aluminum, AlSi10Mg, coated
- Option **D** "Polycarbonate": polycarbonate
- Option **L** "Cast, stainless": 1.4409 (CF3M) similar to 316L



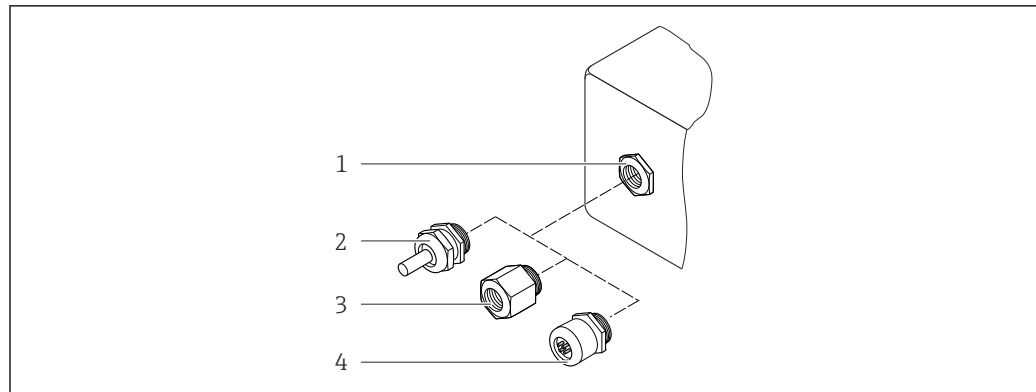

Cable entries/cable glands



A0028352

 55 Possible cable entries/cable glands

- 1 Female thread M20 × 1.5
- 2 Cable gland M20 × 1.5
- 3 Adapter for cable entry with female thread G ½" or NPT ½"
- 4 Device plug

Cable entries and adapters	Material
Cable gland M20 × 1.5	Plastic
<ul style="list-style-type: none"> ■ Adapter for cable entry with female thread G ½" ■ Adapter for cable entry with female thread NPT ½"  Only available for certain device versions: <ul style="list-style-type: none"> ■ Order code for "Transmitter housing": <ul style="list-style-type: none"> ■ Option A "Aluminum, coated" ■ Option D "Polycarbonate" ■ Order code for "Sensor connection housing": <ul style="list-style-type: none"> ■ Proline 500 – digital: <ul style="list-style-type: none"> Option A "Aluminum coated" Option L "Cast, stainless" ■ Proline 500: <ul style="list-style-type: none"> Option A "Aluminum coated" Option L "Cast, stainless" 	Nickel-plated brass
<ul style="list-style-type: none"> ■ Adapter for cable entry with female thread G ½" ■ Adapter for cable entry with female thread NPT ½"  Only available for certain device versions: <ul style="list-style-type: none"> ■ Order code for "Transmitter housing": <ul style="list-style-type: none"> Option L "Cast, stainless" ■ Order code for "Sensor connection housing": <ul style="list-style-type: none"> Option L "Cast, stainless" 	Stainless steel, 1.4404 (316L)
Adapter for device plug  Device plug for digital communication: Only available for certain device versions →  33.	Stainless steel, 1.4404 (316L)

Device plug

Electrical connection	Material
Plug M12x1	<ul style="list-style-type: none"> ■ Socket: Stainless steel, 1.4404 (316L) ■ Contact housing: Polyamide ■ Contacts: Gold-plated brass

Connecting cable

- 
- UV rays can impair the cable outer sheath. Protect the cable from exposure to sun as much as possible.

Connecting cable for sensor - Proline 500 – digital transmitter

PVC cable with copper shield

Connecting cable for sensor - Proline 500 transmitter

PVC cable with copper shield

Sensor housing

- DN 15 to 300 (½ to 12")
Aluminum half-shell housing, aluminum, AlSi10Mg, coated
- DN 25 to 600 (1 to 24")
Fully welded carbon steel housing with protective varnish

Measuring tubes

Stainless steel, 1.4301/304/1.4306/304L

For flanges made of carbon with Al/Zn protective coating (DN 15 to 300 (½ to 12")) or protective varnish (DN 350 to 600 (14 to 24"))

Liner

- PFA
- PTFE

Process connections

EN 1092-1 (DIN 2501)

Stainless steel, 1.4571; carbon steel, E250C ¹⁾/S235JRG2/P245GH

ASME B16.5

Stainless steel, F316L; carbon steel, A105 ¹⁾

JIS B2220

Stainless steel, F316L; carbon steel, A105/A350 LF2 ¹⁾

AS 2129 Table E

- DN 25 (1"): carbon steel, A105/S235JRG2
- DN 40 (1 ½"): carbon steel, A105/S275JR

AS 4087 PN 16

Carbon steel, A105/S275JR

Electrodes

Stainless steel, 1.4435 (F316L); Alloy C22, 2.4602 (UNS N06022); platinum; tantalum; titanium

Seals

As per DIN EN 1514-1, form IBC

Accessories

Protective cover

Stainless steel, 1.4404 (316L)

External WLAN antenna

- Antenna: ASA plastic (acrylic ester-styrene-acrylonitrile) and nickel-plated brass
- Adapter: Stainless steel and nickel-plated brass
- Cable: Polyethylene
- Plug: Nickel-plated brass
- Angle bracket: Stainless steel

1) DN 15 to 300 (½ to 12") with Al/Zn protective varnish; DN 350 to 600 (14 to 24") with protective varnish

Ground disks

- Stainless steel, 1.4435 (316L)
- Alloy C22, 2.4602 (UNS N06022)
- Titanium
- Tantalum

Fitted electrodes

Measuring electrode, reference electrode and empty pipe detection electrode:

- 1.4435 (316L)
- Alloy C22, 2.4602 (UNS N06022)
- Tantalum
- Titanium
- Platinum

Optional: only platinum or tantalum measuring electrode

Process connections

- EN 1092-1 (DIN 2501)
- ASME B16.5
- JIS B2220
- AS 2129 Table E
- AS 4087 PN 16



For information on the different materials used in the process connections → 99

Surface roughness

Stainless steel electrodes, 1.4435 (F316L); Alloy C22, 2.4602 (UNS N06022); platinum; tantalum; titanium:

≤ 0.3 to 0.5 μm (11.8 to 19.7 μin)

(All data refer to parts in contact with the medium)

Liner with PFA:

≤ 0.4 μm (15.7 μin)

(All data refer to parts in contact with the medium)

Operability

Operating concept**Operator-oriented menu structure for user-specific tasks**

- Commissioning
- Operation
- Diagnostics
- Expert level

Fast and safe commissioning

- Guided menus ("Make-it-run" wizards) for applications
- Menu guidance with brief descriptions of the individual parameter functions
- Access to the device via Web server
- WLAN access to the device via mobile handheld terminal, tablet or smart phone

Reliable operation

- Operation in local language
- Uniform operating philosophy applied to device and operating tools
- If replacing electronic modules, transfer the device configuration via the integrated memory (HistoROM backup) which contains the process and measuring device data and the event logbook. No need to reconfigure.

Efficient diagnostic behavior increases measurement availability

- Troubleshooting measures can be called up via the device and in the operating tools
- Diverse simulation options, logbook for events that occur and optional line recorder functions

Languages

Can be operated in the following languages:



- Via local operation
English, German, French, Spanish, Italian, Dutch, Portuguese, Polish, Russian, Turkish, Chinese, Japanese, Korean, Vietnamese, Czech, Swedish
- Via Web browser
English, German, French, Spanish, Italian, Dutch, Portuguese, Polish, Russian, Turkish, Chinese, Japanese, Vietnamese, Czech, Swedish
- Via "FieldCare", "DeviceCare" operating tool: English, German, French, Spanish, Italian, Chinese, Japanese

Local operation

Via display module

Equipment:

- Order code for "Display; operation", option F "4-line, illuminated, graphic display; touch control"
- Order code for "Display; operation", option G "4-line, illuminated, graphic display; touch control + WLAN"

 Information about WLAN interface →  108

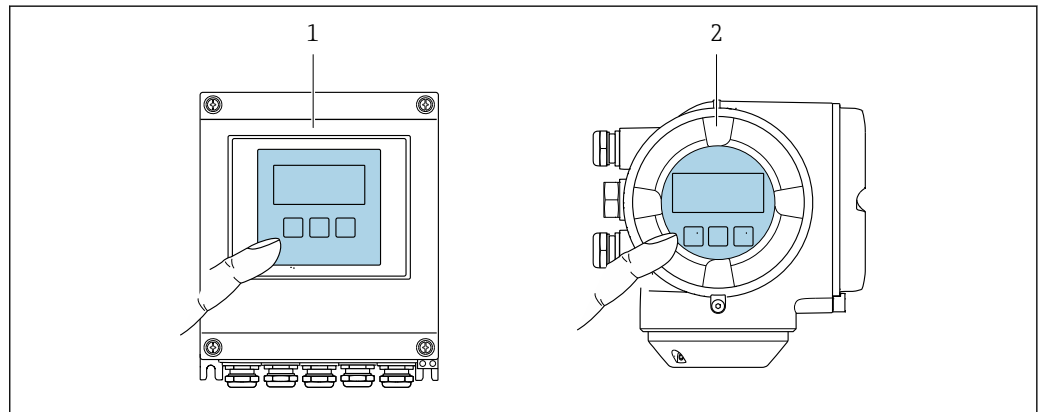



 56 Operation with touch control

- 1 Proline 500 – digital
- 2 Proline 500

Display elements

- 4-line, illuminated, graphic display
- White background lighting; switches to red in event of device errors
- Format for displaying measured variables and status variables can be individually configured
- Permitted ambient temperature for the display: -20 to +60 °C (-4 to +140 °F)
The readability of the display may be impaired at temperatures outside the temperature range.

Operating elements

- External operation via touch control (3 optical keys) without opening the housing: , , 
- Operating elements also accessible in the various zones of the hazardous area

Remote operation

Via HART protocol

This communication interface is available in device versions with a HART output.

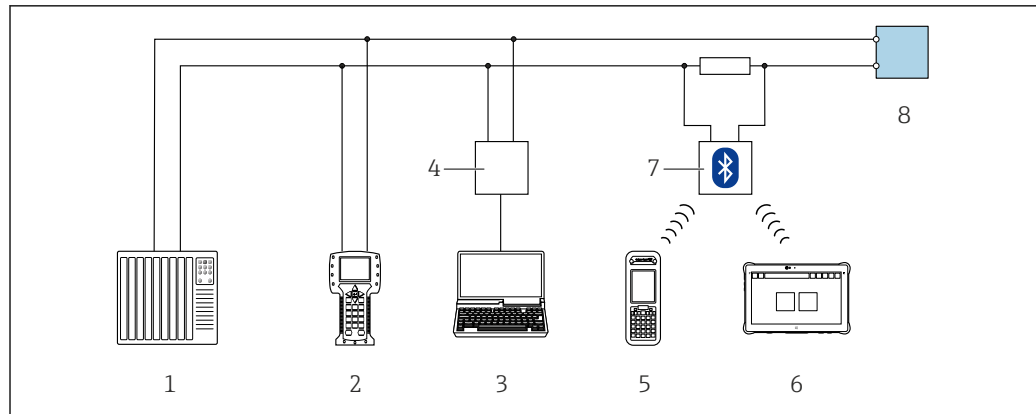

A0028747

57 Options for remote operation via HART protocol (active)

- 1 Control system (e.g. PLC)
- 2 Field Communicator 475
- 3 Computer with Web browser (e.g. Internet Explorer) for accessing the integrated device Web server or computer with operating tool (e.g. FieldCare, DeviceCare, AMS Device Manager, SIMATIC PDM) with COM DTM "CDI Communication TCP/IP"
- 4 Commubox FXA195 (USB)
- 5 Field Xpert SFX350 or SFX370
- 6 Field Xpert SMT70
- 7 VIATOR Bluetooth modem with connecting cable
- 8 Transmitter

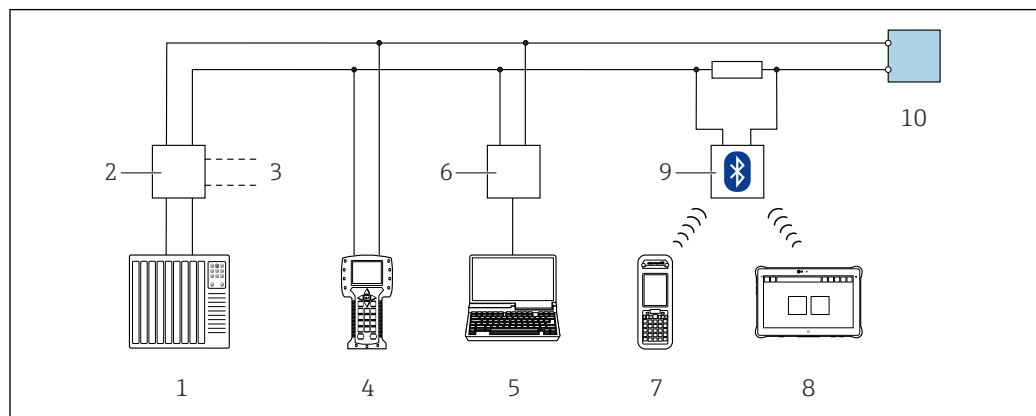

A0028746

58 Options for remote operation via HART protocol (passive)

- 1 Control system (e.g. PLC)
- 2 Transmitter power supply unit, e.g. RN221N (with communication resistor)
- 3 Connection for Commubox FXA195 and Field Communicator 475
- 4 Field Communicator 475
- 5 Computer with Web browser (e.g. Internet Explorer) for accessing the integrated device Web server or computer with operating tool (e.g. FieldCare, DeviceCare, AMS Device Manager, SIMATIC PDM) with COM DTM "CDI Communication TCP/IP"
- 6 Commubox FXA195 (USB)
- 7 Field Xpert SFX350 or SFX370
- 8 Field Xpert SMT70
- 9 VIATOR Bluetooth modem with connecting cable
- 10 Transmitter

Via FOUNDATION Fieldbus network

This communication interface is available in device versions with FOUNDATION Fieldbus.

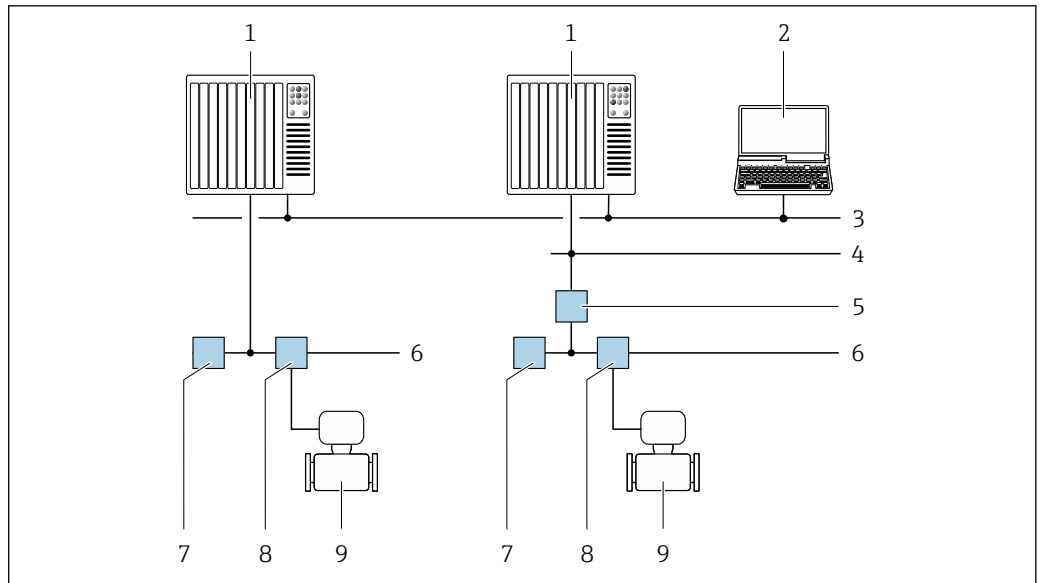

A0028837

59 Options for remote operation via FOUNDATION Fieldbus network

- 1 Automation system
- 2 Computer with FOUNDATION Fieldbus network card
- 3 Industry network
- 4 High Speed Ethernet FF-HSE network
- 5 Segment coupler FF-HSE/FF-H1
- 6 FOUNDATION Fieldbus FF-H1 network
- 7 Power supply FF-H1 network
- 8 T-box
- 9 Measuring device

Via PROFIBUS DP network

This communication interface is available in device versions with PROFIBUS DP.

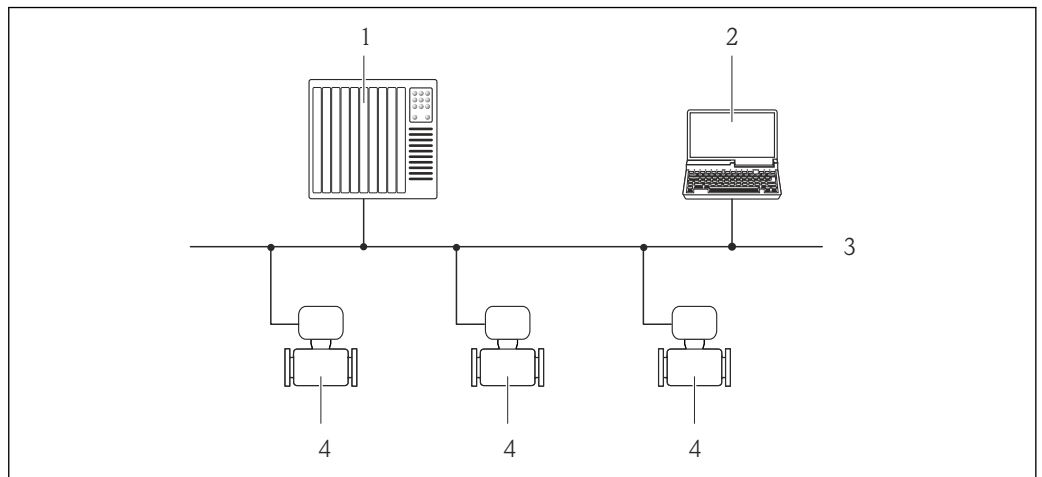

A0020903

60 Options for remote operation via PROFIBUS DP network

- 1 Automation system
- 2 Computer with PROFIBUS network card
- 3 PROFIBUS DP network
- 4 Measuring device

Via PROFIBUS PA network

This communication interface is available in device versions with PROFIBUS PA.

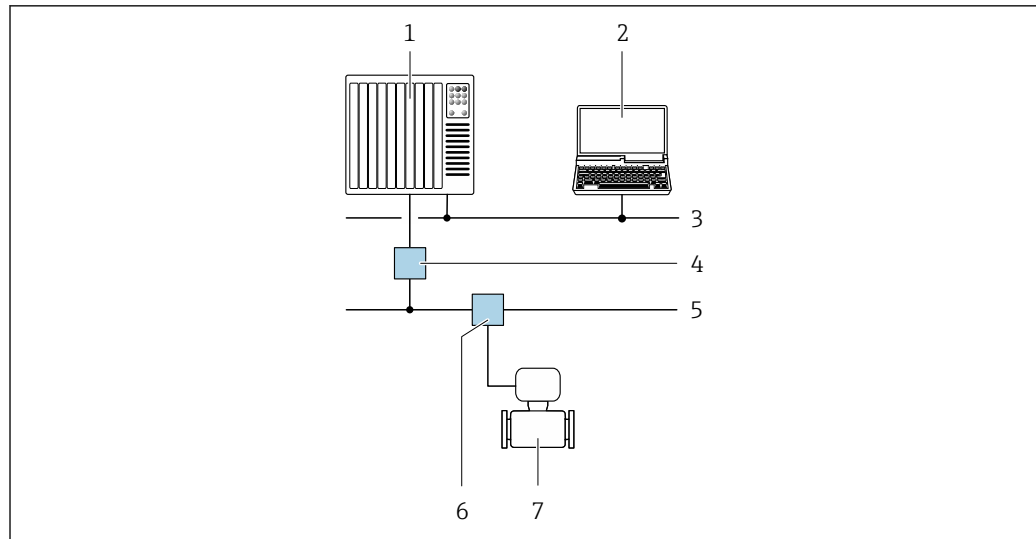

A0028838

61 Options for remote operation via PROFIBUS PA network

- 1 Automation system
- 2 Computer with PROFIBUS network card
- 3 PROFIBUS DP network
- 4 Segment coupler PROFIBUS DP/PA
- 5 PROFIBUS PA network
- 6 T-box
- 7 Measuring device

Via Modbus RS485 protocol

This communication interface is available in device versions with a Modbus-RS485 output.

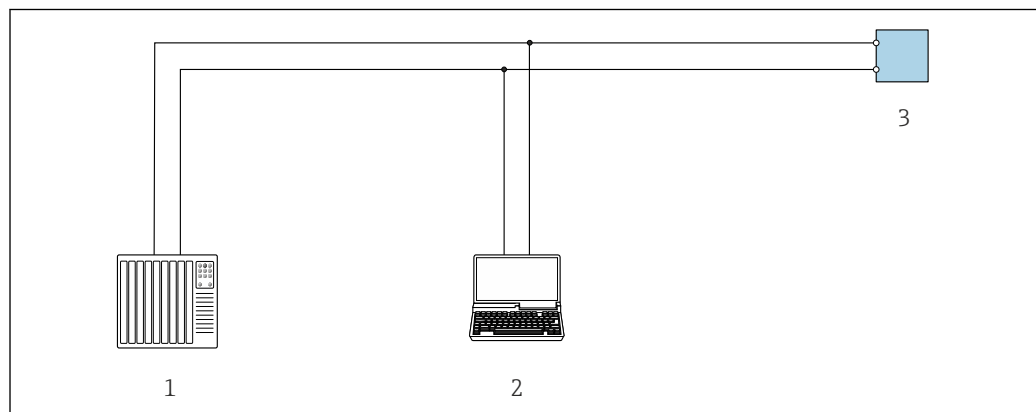

A0029437

62 Options for remote operation via Modbus-RS485 protocol (active)

- 1 Control system (e.g. PLC)
- 2 Computer with Web browser (e.g. Internet Explorer) for accessing the integrated device Web server or with operating tool (e.g. FieldCare, DeviceCare) with COM DTM "CDI Communication TCP/IP" or Modbus DTM
- 3 Transmitter

Via EtherNet/IP network

This communication interface is available in device versions with EtherNet/IP.

Star topology

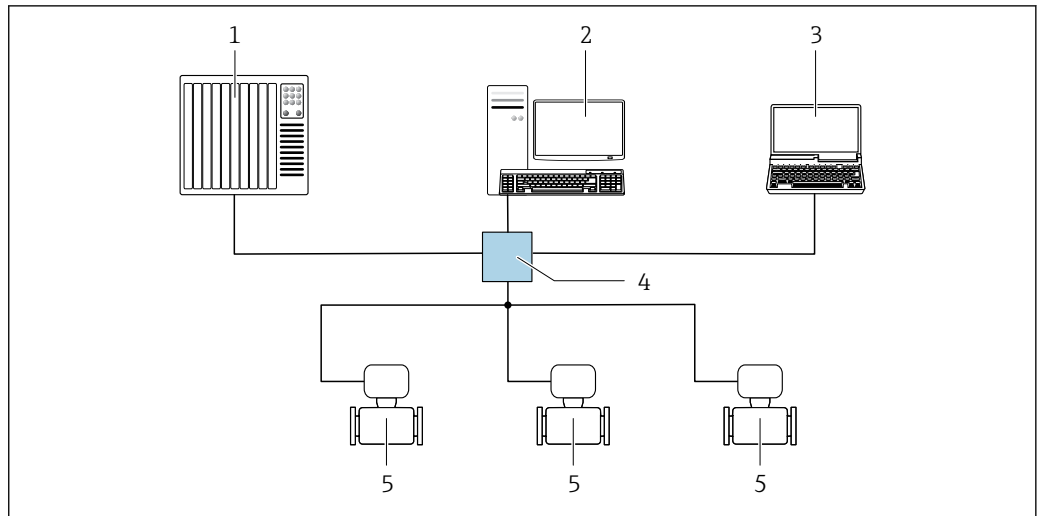

A0032078

63 Options for remote operation via EtherNet/IP network: star topology

- 1 Automation system, e.g. "RSLogix" (Rockwell Automation)
- 2 Workstation for measuring device operation: with Custom Add-On Profile for "RSLogix 5000" (Rockwell Automation) or with Electronic Data Sheet (EDS)
- 3 Computer with Web browser (e.g. Internet Explorer) for accessing the integrated Web server or computer with operating tool (e.g. FieldCare, DeviceCare) with COM DTM "CDI Communication TCP/IP"
- 4 Standard Ethernet switch, e.g. Scalance X204 (Siemens)
- 5 Measuring device

Ring topology

The device is integrated via the terminal connection for signal transmission (output 1) and the service interface (CDI-RJ45).

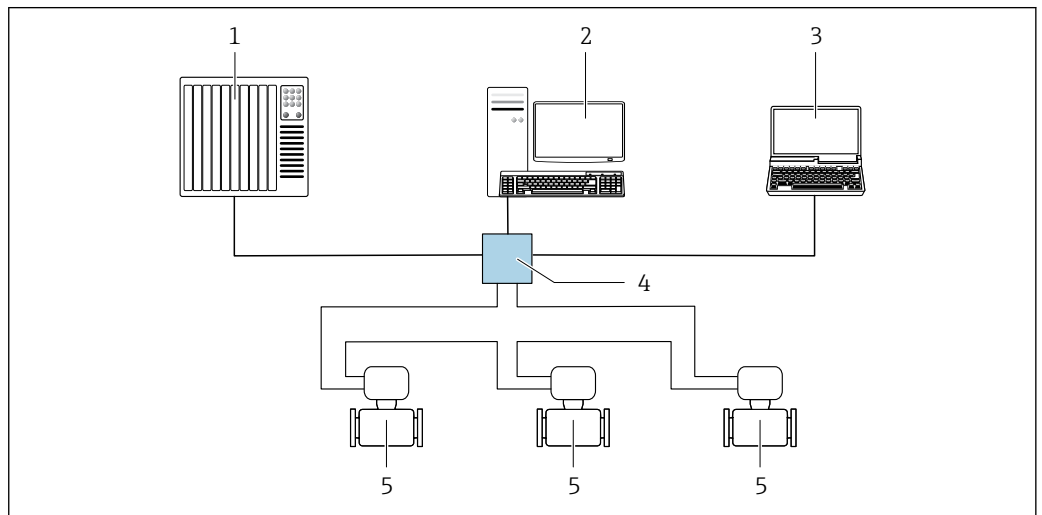

A0033725

64 Options for remote operation via EtherNet/IP network: ring topology

- 1 Automation system, e.g. "RSLogix" (Rockwell Automation)
- 2 Workstation for measuring device operation: with Custom Add-On Profile for "RSLogix 5000" (Rockwell Automation) or with Electronic Data Sheet (EDS)
- 3 Computer with Web browser (e.g. Internet Explorer) for accessing the integrated Web server or computer with operating tool (e.g. FieldCare, DeviceCare) with COM DTM "CDI Communication TCP/IP"
- 4 Standard Ethernet switch, e.g. Scalance X204 (Siemens)
- 5 Measuring device

Via PROFINET network

This communication interface is available in device versions with PROFINET.

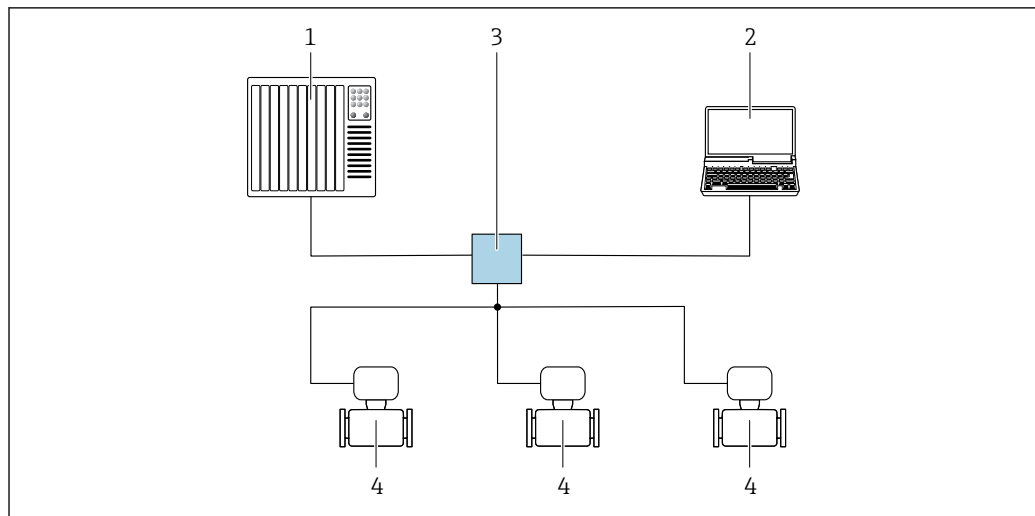
Star topology

A0026545

65 Options for remote operation via PROFINET network: star topology

- 1 Automation system, e.g. Simatic S7 (Siemens)
- 2 Computer with Web browser (e.g. Internet Explorer) for accessing the integrated Web server or computer with operating tool (e.g. FieldCare, DeviceCare, SIMATIC PDM) with COM DTM "CDI Communication TCP/IP"
- 3 Standard Ethernet switch, e.g. Scalance X204 (Siemens)
- 4 Measuring device

Ring topology

The device is integrated via the terminal connection for signal transmission (output 1) and the service interface (CDI-RJ45).

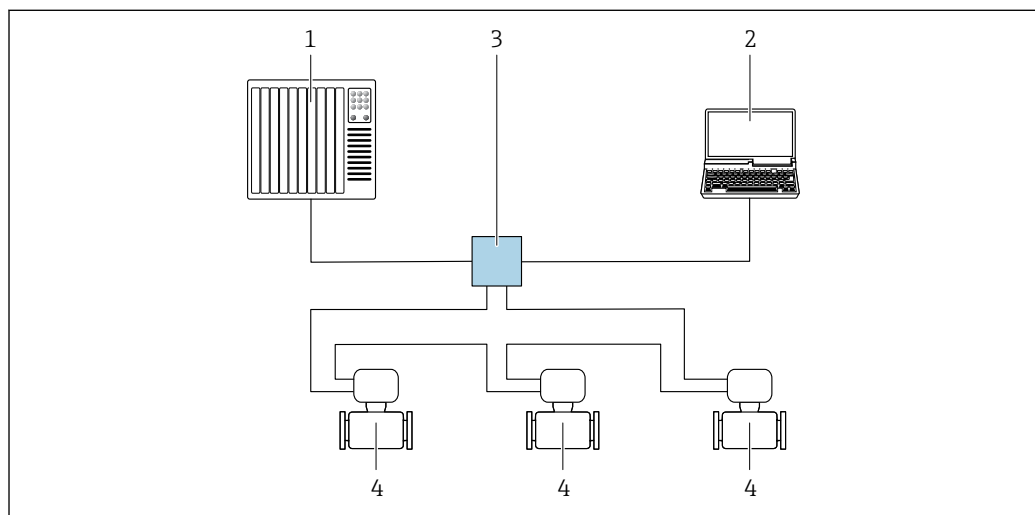

A0033719

66 Options for remote operation via PROFINET network: ring topology

- 1 Automation system, e.g. Simatic S7 (Siemens)
- 2 Computer with Web browser (e.g. Internet Explorer) for accessing the integrated Web server or computer with operating tool (e.g. FieldCare, DeviceCare, SIMATIC PDM) with COM DTM "CDI Communication TCP/IP"
- 3 Standard Ethernet switch, e.g. Scalance X204 (Siemens)
- 4 Measuring device

Via APL network

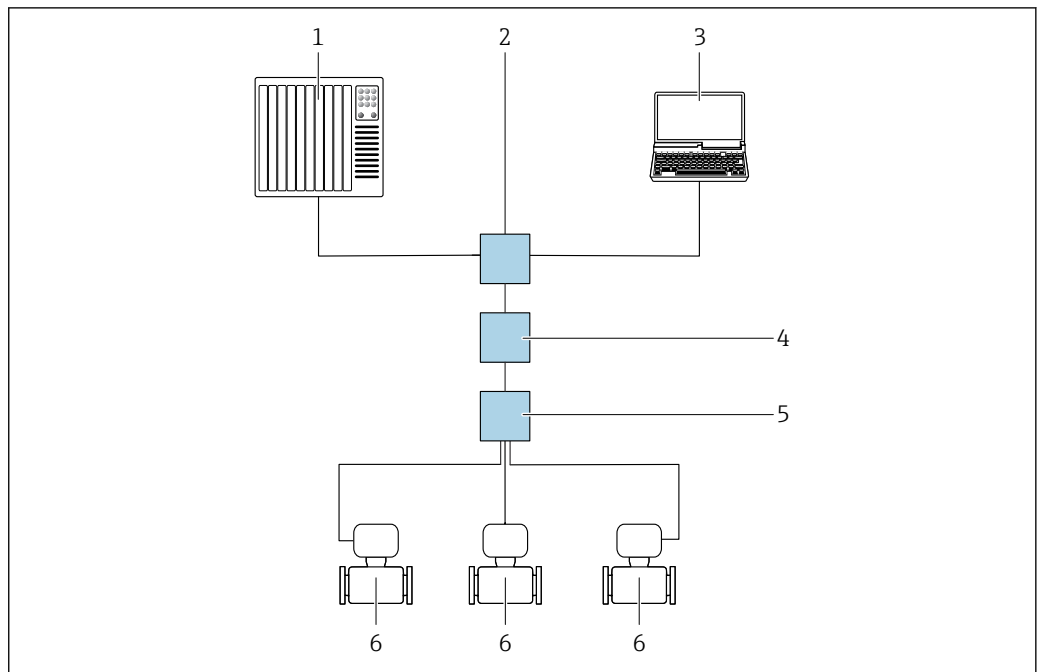

A0046117

67 Options for remote operation via APL network

- 1 Automation system, e.g. Simatic S7 (Siemens)
- 2 Ethernet switch, e.g. Scalance X204 (Siemens)
- 3 Computer with Web browser (e.g. Internet Explorer) for access to integrated Web server or computer with operating tool (e.g. FieldCare or DeviceCare with PROFINET COM DTM or SIMATIC PDM with FDI-Package)
- 4 APL power switch (optional)
- 5 APL field switch
- 6 Measuring device

Service interface

Via service interface (CDI-RJ45)

A point-to-point connection can be established via onsite device configuration. With the housing open, the connection is established directly via the service interface (CDI-RJ45) of the device.



An adapter for RJ45 to the M12 plug is optionally available:

Order code for "Accessories", option **NB**: "Adapter RJ45 M12 (service interface)"

The adapter connects the service interface (CDI-RJ45) to an M12 plug mounted in the cable entry. The connection to the service interface can be established via an M12 plug without opening the device.

Proline 500 – digital transmitter

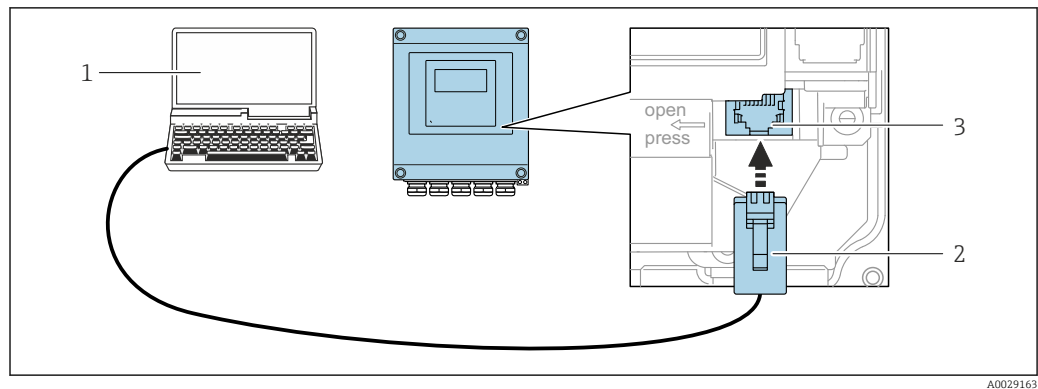

A0029163

 68 Connection via service interface (CDI-RJ45)

- 1 Computer with Web browser (e.g. Microsoft Internet Explorer, Microsoft Edge) for accessing the integrated Web server or with "FieldCare", "DeviceCare" operating tool with COM DTM "CDI Communication TCP/IP" or Modbus DTM
- 2 Standard Ethernet connecting cable with RJ45 plug
- 3 Service interface (CDI-RJ45) of the measuring device with access to the integrated Web server

Proline 500 transmitter

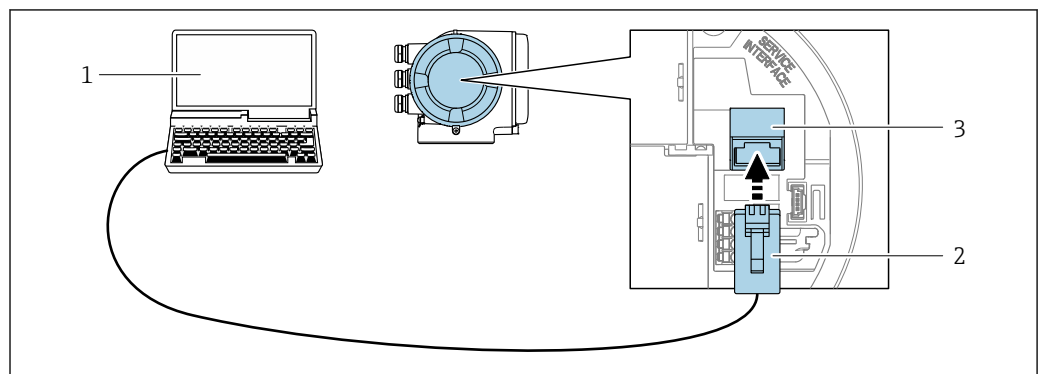

A0027563

 69 Connection via service interface (CDI-RJ45)

- 1 Computer with Web browser (e.g. Microsoft Internet Explorer, Microsoft Edge) for accessing the integrated Web server or with "FieldCare", "DeviceCare" operating tool with COM DTM "CDI Communication TCP/IP" or Modbus DTM
- 2 Standard Ethernet connecting cable with RJ45 plug
- 3 Service interface (CDI-RJ45) of the measuring device with access to the integrated Web server

Via WLAN interface

The optional WLAN interface is available on the following device version:

Order code for "Display; operation", option G "4-line, illuminated; touch control + WLAN"

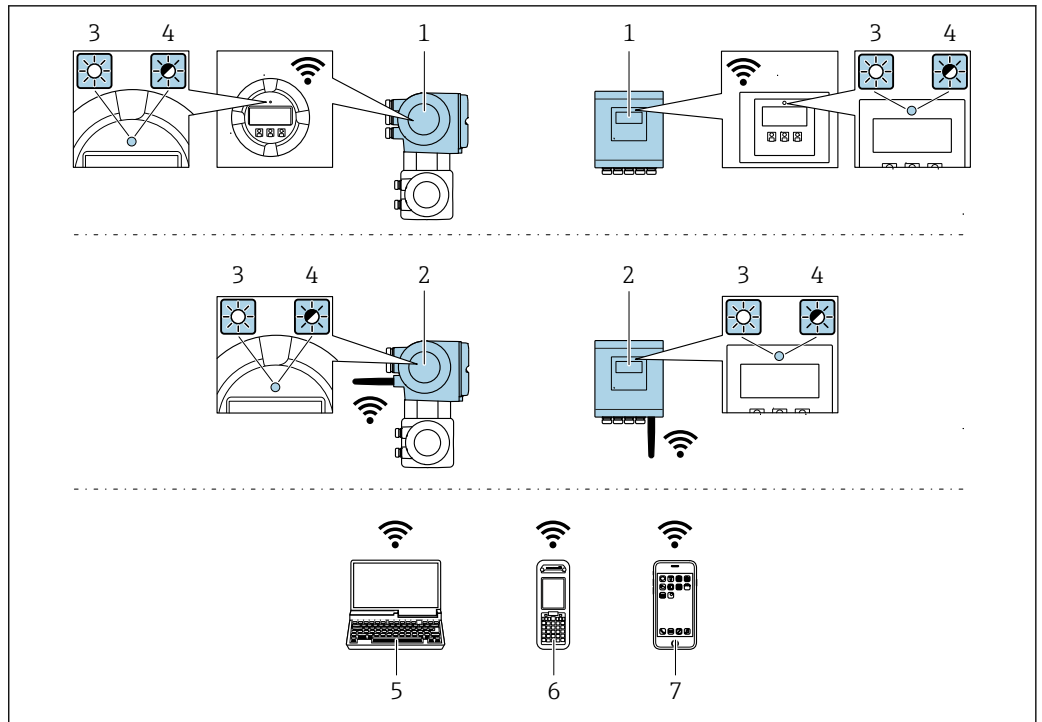

A0034569

- 1 Transmitter with integrated WLAN antenna
- 2 Transmitter with external WLAN antenna
- 3 LED lit constantly: WLAN reception is enabled on measuring device
- 4 LED flashing: WLAN connection established between operating unit and measuring device
- 5 Computer with WLAN interface and Web browser (e.g. Microsoft Internet Explorer, Microsoft Edge) for accessing the integrated device Web server or with operating tool (e.g. FieldCare, DeviceCare)
- 6 Mobile handheld terminal with WLAN interface and Web browser (e.g. Microsoft Internet Explorer, Microsoft Edge) for accessing the integrated device Web server or operating tool (e.g. FieldCare, DeviceCare)
- 7 Smart phone or tablet (e.g. Field Xpert SMT70)

Function	WLAN: IEEE 802.11 b/g (2.4 GHz) <ul style="list-style-type: none"> ▪ Access Point with DHCP server (factory setting) ▪ Network
Encryption	WPA2-PSK AES-128 (in accordance with IEEE 802.11i)
Configurable WLAN channels	1 to 11
Degree of protection	IP67
Available antennas	<ul style="list-style-type: none"> ▪ Internal antenna ▪ External antenna (optional) In the event of poor transmission/reception conditions at the place of installation. Available as an accessory → 120. i Only 1 antenna is active at any one time!
Range	<ul style="list-style-type: none"> ▪ Internal antenna: typically 10 m (32 ft) ▪ External antenna: typically 50 m (164 ft)
Materials (external antenna)	<ul style="list-style-type: none"> ▪ Antenna: ASA plastic (acrylic ester-styrene-acrylonitrile) and nickel-plated brass ▪ Adapter: Stainless steel and nickel-plated brass ▪ Cable: Polyethylene ▪ Plug: Nickel-plated brass ▪ Angle bracket: Stainless steel

Network integration

i Network integration is only available for the HART communication protocol.

With the optional "OPC-UA Server" application package, the device can be integrated into an Ethernet network via the service interface (CDI-RJ45 and WLAN) and communicate with OPC-UA clients. If the device is used in this way, IT security must be considered.

i Transmitters with an Ex de approval may **not** be connected via the service interface (CDI-RJ45)!
Order code for "Approval transmitter + sensor", options (Ex de):
BB, C2, GB, MB, NB

For permanent access to device data and for device configuration via the Web server, the device is incorporated directly in a network via the service interface (CDI-RJ45). In this way, the device can be accessed any time from the control station. The measured values are processed separately via the inputs and outputs through the automation system.

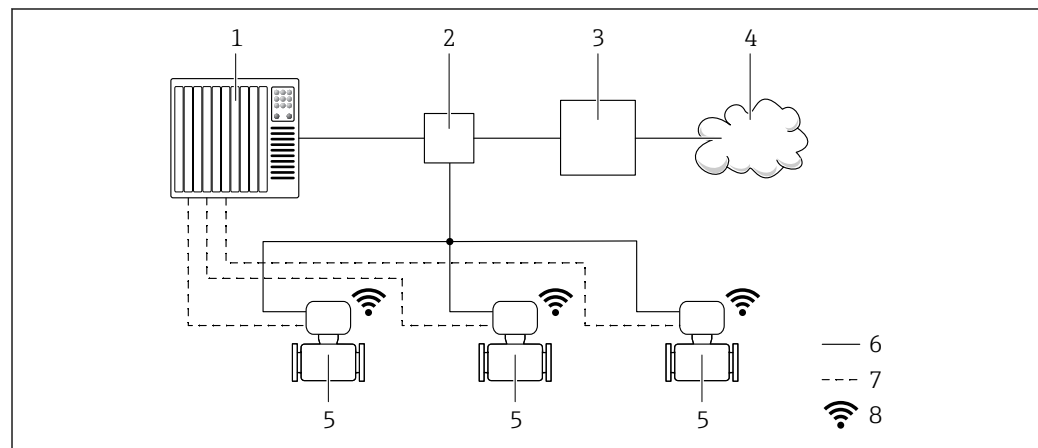

A0033618

- 1 Automation system, e.g. Simatic S7 (Siemens)
- 2 Ethernet switch
- 3 Edge Gateway
- 4 Cloud
- 5 Measuring device
- 6 Ethernet network
- 7 Measured values via inputs and outputs
- 8 Optional WLAN interface

i The optional WLAN interface is available on the following device version:
Order code for "Display; operation", option **G** "4-line, backlit, graphic display; touch control + WLAN"

📖 Special Documentation for the OPC-UA Server application package → **📄** 124.

Supported operating tools

Different operating tools can be used for local or remote access to the measuring device. Depending on the operating tool used, access is possible with different operating units and via a variety of interfaces.

Supported operating tools	Operating unit	Interface	Additional information
Web browser	Notebook, PC or tablet with Web browser	<ul style="list-style-type: none"> ■ CDI-RJ45 service interface ■ WLAN interface ■ Ethernet-based fieldbus (EtherNet/IP, PROFINET) 	Special Documentation for the device
DeviceCare SFE100	Notebook, PC or tablet with Microsoft Windows system	<ul style="list-style-type: none"> ■ CDI-RJ45 service interface ■ WLAN interface ■ Fieldbus protocol 	→ 📄 122
FieldCare SFE500	Notebook, PC or tablet with Microsoft Windows system	<ul style="list-style-type: none"> ■ CDI-RJ45 service interface ■ WLAN interface ■ Fieldbus protocol 	→ 📄 122

Supported operating tools	Operating unit	Interface	Additional information
Field Xpert	SMT70/77/50	<ul style="list-style-type: none"> ■ All fieldbus protocols ■ WLAN interface ■ Bluetooth ■ CDI-RJ45 service interface 	Operating Instructions BA01202S Device description files: Use update function of handheld terminal
SmartBlue app	Smart phone or tablet with iOS or Android	WLAN	→  122



Other operating tools based on FDT technology with a device driver such as DTM/iDTM or DD/EDD can be used for device operation. These operating tools are available from the individual manufacturers. Integration into the following operating tools, among others, is supported:

- FactoryTalk AssetCentre (FTAC) from Rockwell Automation → www.rockwellautomation.com
- Process Device Manager (PDM) from Siemens → www.siemens.com
- Asset Management Solutions (AMS) from Emerson → www.emersonprocess.com
- FieldCommunicator 375/475 from Emerson → www.emersonprocess.com
- Field Device Manager (FDM) from Honeywell → www.process.honeywell.com
- FieldMate from Yokogawa → www.yokogawa.com
- PACTWare → www.pactware.com

The related device description files are available: www.endress.com → Downloads

Web server

Thanks to the integrated Web server the device can be operated and configured via a Web browser and via the service interface (CDI-RJ45) or via the WLAN interface. The structure of the operating menu is the same as for the local display. In addition to the measured values, device status information is also displayed and allows users to monitor the status of the device. Furthermore the device data can be managed and the network parameters can be configured.

A device that has a WLAN interface (can be ordered as an option) is required for the WLAN connection: order code for "Display; operation", option G "4-line, illuminated; touch control + WLAN". The device acts as an Access Point and enables communication by computer or a mobile handheld terminal.

Supported functions

Data exchange between the operating unit (such as a notebook for example) and the measuring device:

- Upload the configuration from the measuring device (XML format, configuration backup)
- Save the configuration to the measuring device (XML format, restore configuration)
- Export event list (.csv file)
- Export parameter settings (.csv file or PDF file, document the measuring point configuration)
- Export the Heartbeat verification log (PDF file, only available with the "Heartbeat Verification" application package)
- Flash firmware version for device firmware upgrade, for instance
- Download driver for system integration
- Visualize up to 1000 saved measured values (only available with the **Extended HistoROM** application package →  118)



Web server special documentation →  124

HistoROM data management

The measuring device features HistoROM data management. HistoROM data management comprises both the storage and import/export of key device and process data, making operation and servicing far more reliable, secure and efficient.



When the device is delivered, the factory settings of the configuration data are stored as a backup in the device memory. This memory can be overwritten with an updated data record, for example after commissioning.

Additional information on the data storage concept

There are different types of data storage units in which device data are stored and used by the device:

	HistoROM backup	T-DAT	S-DAT
Available data	<ul style="list-style-type: none"> ▪ Event logbook such as diagnostic events for example ▪ Parameter data record backup ▪ Device firmware package ▪ Driver for system integration for exporting via Web server, e.g.: <ul style="list-style-type: none"> ▪ GSD for PROFIBUS DP ▪ GSD for PROFIBUS PA ▪ GSDML for PROFINET ▪ EDS for EtherNet/IP ▪ DD for FOUNDATION Fieldbus 	<ul style="list-style-type: none"> ▪ Measured value logging ("Extended HistoROM" order option) ▪ Current parameter data record (used by firmware at run time) ▪ Maximum indicators (min/max values) ▪ Totalizer values 	<ul style="list-style-type: none"> ▪ Sensor data: nominal diameter etc. ▪ Serial number ▪ Calibration data ▪ Device configuration (e.g. SW options, fixed I/O or multi I/O)
Storage location	Fixed on the user interface board in the connection compartment	Attachable to the user interface board in the connection compartment	In the sensor plug in the transmitter neck part

Data backup

Automatic

- The most important device data (sensor and transmitter) are automatically saved in the DAT modules
- If the transmitter or measuring device is replaced: once the T-DAT containing the previous device data has been exchanged, the new measuring device is ready for operation again immediately without any errors
- If the sensor is replaced: once the sensor has been replaced, new sensor data are transferred from the S-DAT in the measuring device and the measuring device is ready for operation again immediately without any errors
- If exchanging the electronics module (e.g. I/O electronics module): Once the electronics module has been replaced, the software of the module is compared against the current device firmware. The module software is upgraded or downgraded where necessary. The electronics module is available for use immediately afterwards and no compatibility problems occur.

Manual

Additional parameter data record (complete parameter settings) in the integrated device memory HistoROM backup for:

- Data backup function
Backup and subsequent restoration of a device configuration in the device memory HistoROM backup
- Data comparison function
Comparison of the current device configuration with the device configuration saved in the device memory HistoROM backup

Data transmission

Manual

- Transfer of a device configuration to another device using the export function of the specific operating tool, e.g. with FieldCare, DeviceCare or Web server: to duplicate the configuration or to store in an archive (e.g. for backup purposes)
- Transmission of the drivers for system integration via Web server, e.g.:
 - GSD for PROFIBUS DP
 - GSD for PROFIBUS PA
 - GSDML for PROFINET
 - EDS for EtherNet/IP
 - DD for FOUNDATION Fieldbus

Event list

Automatic

- Chronological display of up to 20 event messages in the events list
- If the **Extended HistoROM** application package (order option) is enabled: up to 100 event messages are displayed in the events list along with a time stamp, plain text description and remedial measures
- The events list can be exported and displayed via a variety of interfaces and operating tools e.g. DeviceCare, FieldCare or Web server

Data logging

Manual

If the **Extended HistoROM** application package (order option) is enabled:

- Record up to 1 000 measured values via 1 to 4 channels
- User configurable recording interval
- Record up to 250 measured values via each of the 4 memory channels
- Export the measured value log via a variety of interfaces and operating tools e.g. FieldCare, DeviceCare or web server

Certificates and approvals

Current certificates and approvals that are available for the product can be selected via the Product Configurator at www.endress.com:

1. Select the product using the filters and search field.
2. Open the product page.
3. Select **Configuration**.

CE mark

The device meets the legal requirements of the applicable EU Directives. These are listed in the corresponding EU Declaration of Conformity along with the standards applied.

Endress+Hauser confirms successful testing of the device by affixing to it the CE mark.

UKCA marking

The device meets the legal requirements of the applicable UK regulations (Statutory Instruments). These are listed in the UKCA Declaration of Conformity along with the designated standards. By selecting the order option for UKCA marking, Endress+Hauser confirms a successful evaluation and testing of the device by affixing the UKCA mark.

Contact address Endress+Hauser UK:

Endress+Hauser Ltd.
 Floats Road
 Manchester M23 9NF
 United Kingdom
www.uk.endress.com

RCM mark

The measuring system meets the EMC requirements of the "Australian Communications and Media Authority (ACMA)".

Ex approval

The measuring device is certified for use in hazardous areas and the relevant safety instructions are provided in the separate "Safety Instructions" (XA) document. Reference is made to this document on the nameplate.

-  The separate Ex documentation (XA) containing all the relevant explosion protection data is available from your Endress+Hauser sales center.

Proline 500 – digital

ATEX, IECEx

Currently, the following versions for use in hazardous areas are available:

Ex ia, Ex db

Transmitter		Sensor	
Category	Type of protection	Category	Type of protection
II(1)G	[Ex ia] IIC	II2G	Ex db ia IIC T6...T1 Gb
II3(1)G	Ex ec [ia Ga] IIC T5...T4 Gc	II2G	Ex db ia IIC T6...T1 Gb

Ex tb

Transmitter		Sensor	
Category	Type of protection	Category	Type of protection
II(1)D	[Ex ia] IIIC	II2D	Ex ia tb IIIC T** °C Db

Non-Ex, Ex ec

Transmitter		Sensor	
Category	Type of protection	Category	Type of protection
Non-Ex	Non-Ex	II3G	Ex ec ic IIC T5...T1 Gc
II3G	Ex ec IIC T5...T4 Gc	II3G	Ex ec ic IIC T5...T1 Gc

cCSAus

Currently, the following versions for use in hazardous areas are available:

IS (Ex nA, Ex i)

Transmitter	Sensor
Class I Division 2 Groups A - D	Class I, II, III Division 1 Groups A-G

NI (Ex nA)

Transmitter	Sensor
Class I Division 2 Groups A - D	

Ex nA, Ex i

Transmitter	Sensor
Class I, Zone 2 AEx/ Ex nA [ia Ga] IIC T5...T4 Gb	Class I, Zone 1 AEx/ Ex d ia IIC T6...T1 Gb

Ex nA

Transmitter	Sensor
Class I, Zone 2 AEx/ Ex nA IIC T5...T4 Gc	Class I, Zone 2 AEx/Ex nA ic IIC T5...T1 Gc

Ex tb

Transmitter	Sensor
[AEx / Ex ia] IIIC	Zone 2 1 AEx/ Ex ia tb IIIC T** °C Db

Proline 500*ATEX, IECEx*

Currently, the following versions for use in hazardous areas are available:

Ex db eb

Category	Type of protection	
	Transmitter	Sensor
II2G	Ex db eb ia IIC T6...T4 Gb	Ex eb ia IIC T6...T1 Gb

Ex db

Category	Type of protection	
	Transmitter	Sensor
II2G	Ex db ia IIC T6...T4 Gb	Ex eb ia IIC T6...T1 Gb

Ex tb

Category	Type of protection	
	Transmitter	Sensor
II2G	Ex tb IIIC T85°C Db	Ex ia tb IIIC T** °C Db

Ex ec

Category	Type of protection	
	Transmitter	Sensor
II3G	Ex ec IIC T5...T4 Gc	Ex ec ic IIC T5...T1 Gc

cCSAus

Currently, the following versions for use in hazardous areas are available:

IS (Ex i), XP (Ex d)

Transmitter	Sensor
Class I, II, III Division 1 Groups A-G	

NI (Ex nA)

Transmitter	Sensor
Class I Division 2 Groups A - D	

Ex de

Transmitter	Sensor
Class I, Zone 1 AEx/ Ex de ia IIC T6...T4 Gb	Class I, Zone 1 AEx/Ex e ia IIC T6...T1 Gb

Ex d

Transmitter	Sensor
Class I, Zone 1 AEx/ Ex d ia IIC T6...T4 Gb	Class I, Zone 1 AEx/Ex e ia IIC T6...T1 Gb

Ex nA

Transmitter	Sensor
Class I, Zone 2 AEx/ Ex nA IIC T5...T4 Gc	Class I, Zone 2 AEx/Ex nA ic IIC T5...T1 Gc

Ex tb

Transmitter	Sensor
Zone 21 AEx/ Ex tb IIIC T85 °C Db	Zone 21 AEx/ Ex ia tb IIIC T** °C Db

Functional safety

The measuring device can be used for flow monitoring systems (min., max., range) up to SIL 2 (single-channel architecture; order code for "Additional approval", option LA) and SIL 3 (multi-channel architecture with homogeneous redundancy) and is independently evaluated and certified in accordance with IEC 61508.

The following types of monitoring in safety equipment are possible:

 Functional Safety Manual with information on the SIL device →  123

HART certification**HART interface**

The measuring device is certified and registered by the FieldComm Group. The measuring system meets all the requirements of the following specifications:

- Certified according to HART 7
- The device can also be operated with certified devices of other manufacturers (interoperability)

FOUNDATION Fieldbus certification**FOUNDATION Fieldbus interface**

The measuring device is certified and registered by the FieldComm Group. The measuring system meets all the requirements of the following specifications:

- Certified in accordance with FOUNDATION Fieldbus H1
- Interoperability Test Kit (ITK), revision version 6.2.0 (certificate available on request)
- Physical Layer Conformance Test
- The device can also be operated with certified devices of other manufacturers (interoperability)

Certification PROFIBUS**PROFIBUS interface**

The measuring device is certified and registered by the PNO (PROFIBUS Nutzerorganisation e.V./ PROFIBUS User Organization). The measuring system meets all the requirements of the following specifications:

- Certified according to PA Profile 3.02
- The device can also be operated with certified devices of other manufacturers (interoperability)

EtherNet/IP certification

The measuring device is certified and registered by the ODVA (Open Device Vendor Association). The measuring system meets all the requirements of the following specifications:

- Certified in accordance with the ODVA Conformance Test
- EtherNet/IP Performance Test
- EtherNet/IP PlugFest compliance
- The device can also be operated with certified devices of other manufacturers (interoperability)

Certification PROFINET**PROFINET interface**

The measuring device is certified and registered by the PNO (PROFIBUS Nutzerorganisation e.V. / PROFIBUS User Organization). The measuring system meets all the requirements of the following specifications:

- Certified according to:
 - Test specification for PROFINET devices
 - PROFINET Security Level 2 – Netload Class 2 0 Mbps
- The device can also be operated with certified devices of other manufacturers (interoperability)
- The device supports PROFINET S2 system redundancy.

Certification PROFINET with Ethernet-APL**PROFINET interface**

The measuring device is certified and registered by the PNO (PROFIBUS Nutzerorganisation e.V. / PROFIBUS User Organization). The measuring system meets all the requirements of the following specifications:

- Certified according to:
 - Test specification for PROFINET devices
 - PROFINET PA Profile 4
 - PROFINET Security Level 2– Netload Class 2 0 Mbps
 - APL conformance test
- The device can also be operated with certified devices of other manufacturers (interoperability)
- The device supports PROFINET S2 system redundancy.

Radio approval

The measuring device has radio approval.



For detailed information on the radio approval, see the Special Documentation

Pressure Equipment Directive

The devices can be ordered with or without a PED or UKCA approval. If a device with a PED or UKCA approval is required, this must be explicitly stated in the order. For devices with nominal diameters less than or equal to DN 25 (1"), this is neither possible nor necessary. A UK Ex approval must be selected for UKCA.

- With the marking:
 - a) PED/G1/x (x = category) or
 - b) UK/G1/x (x = category)
 on the sensor nameplate, Endress+Hauser confirms compliance with the "Essential Safety Requirements"
 - a) specified in Annex I of the Pressure Equipment Directive 2014/68/EU or
 - b) Schedule 2 of Statutory Instruments 2016 No. 1105.
- Devices bearing this marking (PED or UKCA) are suitable for the following types of medium: Media in Group 1 and 2 with a vapor pressure greater than, or smaller and equal to 0.5 bar (7.3 psi)
- Devices not bearing this marking (without PED or UKCA) are designed and manufactured according to sound engineering practice. They meet the requirements of
 - a) Art. 4 Para. 3 of the Pressure Equipment Directive 2014/68/EU or
 - b) Part 1, Para. 8 of Statutory Instruments 2016 No. 1105.
 The scope of application is indicated
 - a) in diagrams 6 to 9 in Annex II of the Pressure Equipment Directive 2014/68/EU or
 - b) Schedule 3, Para. 2 of Statutory Instruments 2016 No. 1105.

Additional certification**PWIS-free**

PWIS = paint-wetting impairment substances

Order code for "Service":

- Option **HC**: PWIS-free (version A)
- Option **HD**: PWIS-free (version B)
- Option **HE**: PWIS-free (version C)



For more information on PWIS-free certification, see "Test specification" document TS01028D

Other standards and guidelines

- EN 60529
Degrees of protection provided by enclosures (IP code)
- EN 61010-1
Safety requirements for electrical equipment for measurement, control and laboratory use - general requirements
- IEC/EN 61326-2-3
Emission in accordance with Class A requirements. Electromagnetic compatibility (EMC requirements).
- NAMUR NE 21
Electromagnetic compatibility (EMC) of industrial process and laboratory control equipment
- NAMUR NE 32
Data retention in the event of a power failure in field and control instruments with microprocessors

- NAMUR NE 43
Standardization of the signal level for the breakdown information of digital transmitters with analog output signal.
- NAMUR NE 53
Software of field devices and signal-processing devices with digital electronics
- NAMUR NE 105
Specifications for integrating fieldbus devices in engineering tools for field devices
- NAMUR NE 107
Self-monitoring and diagnosis of field devices
- NAMUR NE 131
Requirements for field devices for standard applications

Ordering information

Detailed ordering information is available from your nearest sales organization www.addresses.endress.com or in the Product Configurator at www.endress.com:

1. Select the product using the filters and search field.
2. Open the product page.
3. Select **Configuration**.



Product Configurator - the tool for individual product configuration

- Up-to-the-minute configuration data
- Depending on the device: Direct input of measuring point-specific information such as measuring range or operating language
- Automatic verification of exclusion criteria
- Automatic creation of the order code and its breakdown in PDF or Excel output format
- Ability to order directly in the Endress+Hauser Online Shop

Application packages

Many different application packages are available to enhance the functionality of the device. Such packages might be needed to address safety aspects or specific application requirements.

The application packages can be ordered with the device or subsequently from Endress+Hauser. Detailed information on the order code in question is available from your local Endress+Hauser sales center or on the product page of the Endress+Hauser website: www.endress.com.

Diagnostic functionality

Order code for "Application package", option EA "Extended HistoROM"

Comprises extended functions concerning the event log and the activation of the measured value memory.

Event log:

Memory volume is extended from 20 message entries (standard version) to up to 100 entries.

Data logging (line recorder):

- Memory capacity for up to 1000 measured values is activated.
- 250 measured values can be output via each of the 4 memory channels. The recording interval can be defined and configured by the user.
- Measured value logs can be accessed via the local display or operating tool e.g. FieldCare, DeviceCare or Web server.



For detailed information, see the Operating Instructions for the device.

Heartbeat Technology

Order code for "Application package", option EB "Heartbeat Verification + Monitoring"

Heartbeat Verification

Meets the requirement for traceable verification to DIN ISO 9001:2008 Chapter 7.6 a) "Control of monitoring and measuring equipment".

- Functional testing in the installed state without interrupting the process.
- Traceable verification results on request, including a report.
- Simple testing process via local operation or other operating interfaces.
- Clear measuring point assessment (pass/fail) with high test coverage within the framework of manufacturer specifications.
- Extension of calibration intervals according to operator's risk assessment.

Heartbeat Monitoring

Continuously supplies data, which are characteristic of the measuring principle, to an external condition monitoring system for the purpose of preventive maintenance or process analysis. These data enable the operator to:

- Draw conclusions - using these data and other information - about the impact the process influences (e.g. formation of buildup, magnetic field interference etc.) have on measuring performance over time.
- Schedule servicing in time.
- Monitor the process or product quality.



For detailed information, see the Special Documentation for the device.

Cleaning

Order code for "Application package", option EC "ECC electrode cleaning "

The electrode cleaning circuit (ECC) function has been developed to have a solution for applications where magnetite (Fe_3O_4) deposits frequently occur (e.g. hot water). Since magnetite is highly conductive this build up leads to measuring errors and ultimately to the loss of signal. The application package is designed to avoid build-up of very conductive matter and thin layers (typical of magnetite).



For detailed information, see the Operating Instructions for the device.

OPC-UA Server

Order code for "Application package", option EL "OPC-UA Server"

The application package provides an integrated OPC-UA server for comprehensive device services for IoT and SCADA applications.



For detailed information, see the Special Documentation for the device.















Accessories



Various accessories, which can be ordered with the device or subsequently from Endress+Hauser, are available for the device. Detailed information on the order code in question is available from your local Endress+Hauser sales center or on the product page of the Endress+Hauser website:

www.endress.com.

Device-specific accessories

For the transmitter





Accessories	Description
Transmitter <ul style="list-style-type: none"> ▪ Proline 500 – digital ▪ Proline 500 	Transmitter for replacement or storage. Use the order code to define the following specifications: <ul style="list-style-type: none"> ▪ Approvals ▪ Output ▪ Input ▪ Display/operation ▪ Housing ▪ Software <p> <ul style="list-style-type: none"> ▪ Proline 500 – digital transmitter: Order number: 5X5BXX-*****A ▪ Proline 500 transmitter: Order number: 5X5BXX-*****B </p> <p> Proline 500 transmitter for replacement: It is essential to specify the serial number of the current transmitter when ordering. On the basis of the serial number, the device-specific data (e.g. calibration factors) of the replaced device can be used for the new transmitter.</p> <p> <ul style="list-style-type: none"> ▪ Proline 500 – digital transmitter: Installation Instructions EA01151D ▪ Proline 500 transmitter: Installation Instructions EA01152D </p>
External WLAN antenna	External WLAN antenna with 1.5 m (59.1 in) connecting cable and two angle brackets. Order code for "Accessory enclosed", option P8 "Wireless antenna wide area". <ul style="list-style-type: none">  <ul style="list-style-type: none"> ▪ The external WLAN antenna is not suitable for use in hygienic applications. ▪ Additional information regarding the WLAN interface →  108.  Order number: 71351317  Installation Instructions EA01238D
Pipe mounting set	Pipe mounting set for transmitter. <ul style="list-style-type: none">  Proline 500 – digital transmitter Order number: 71346427  Installation Instructions EA01195D  Proline 500 transmitter Order number: 71346428
Weather protection cover Transmitter <ul style="list-style-type: none"> ▪ Proline 500 – digital ▪ Proline 500 	Is used to protect the measuring device from the effects of the weather: e.g. rainwater, excess heating from direct sunlight. <ul style="list-style-type: none">  <ul style="list-style-type: none"> ▪ Proline 500 – digital transmitter Order number: 71343504 ▪ Proline 500 transmitter Order number: 71343505  Installation Instructions EA01191D
Display guard Proline 500 – digital	Is used to protect the display against impact or scoring, for example from sand in desert areas. <ul style="list-style-type: none">  Order number: 71228792  Installation Instructions EA01093D
Ground cable	Set, consisting of two ground cables for potential equalization.



<p>Connecting cable Proline 500 – digital Sensor – Transmitter</p>	<p>The connecting cable can be ordered directly with the measuring device (order code for "Cable, sensor connection) or as an accessory (order number DK5012).</p> <p>The following cable lengths are available: order code for "Cable, sensor connection"</p> <ul style="list-style-type: none"> ▪ Option B: 20 m (65 ft) ▪ Option E: User-configurable up to max. 50 m ▪ Option F: User-configurable up to max. 165 ft <p> Maximum possible cable length for a Proline 500 – digital connecting cable: 300 m (1000 ft)</p>
<p>Connecting cable Proline 500 Sensor – Transmitter</p>	<p>The connecting cable can be ordered directly with the measuring device (order code for "Cable, sensor connection") or as an accessory (order number DK5012).</p> <p>The following cable lengths are available: order code for "Cable, sensor connection"</p> <ul style="list-style-type: none"> ▪ Option 1: 5 m (16 ft) ▪ Option 2: 10 m (32 ft) ▪ Option 3: 20 m (65 ft) ▪ Option 4: User-configurable cable length (m) ▪ Option 5: User-configurable cable length (ft) <p> Possible cable length for a Proline 500 connecting cable: depending on the medium conductivity, max. 200 m (660 ft)</p>

For the sensor



Accessories	Description
<p>Ground disks</p>	<p>Are used to ground the medium in lined measuring tubes to ensure proper measurement.</p> <p> For details, see Installation Instructions EA00070D</p>

Communication-specific accessories



Accessories	Description
<p>Commubox FXA195 HART</p>	<p>For intrinsically safe HART communication with FieldCare via the USB interface.</p> <p> Technical Information TI00404F</p>
<p>HART Loop Converter HMX50</p>	<p>Is used to evaluate and convert dynamic HART process variables to analog current signals or limit values.</p> <p> <ul style="list-style-type: none"> ▪ Technical Information TI00429F ▪ Operating Instructions BA00371F </p>
<p>Fieldgate FXA42</p>	<p>Is used to transmit the measured values of connected 4 to 20 mA analog measuring devices, as well as digital measuring devices</p> <p> <ul style="list-style-type: none"> ▪ Technical Information TI01297S ▪ Operating Instructions BA01778S ▪ Product page: www.endress.com/fxa42 </p>
<p>Field Xpert SMT50</p>	<p>The Field Xpert SMT70 tablet PC for device configuration enables mobile plant asset management in non-hazardous areas. It is suitable for commissioning and maintenance staff to manage field instruments with a digital communication interface and to record progress.</p> <p>This tablet PC is designed as an all-in-one solution with a preinstalled driver library and is an easy-to-use, touch-sensitive tool which can be used to manage field instruments throughout their entire life cycle.</p> <p> <ul style="list-style-type: none"> ▪ Technical Information TI01342S ▪ Operating Instructions BA01709S ▪ Product page: www.endress.com/smt50 </p>

Field Xpert SMT70	<p>The Field Xpert SMT70 tablet PC for device configuration enables mobile plant asset management in hazardous and non-hazardous areas. It is suitable for commissioning and maintenance staff to manage field instruments with a digital communication interface and to record progress.</p> <p>This tablet PC is designed as an all-in-one solution with a preinstalled driver library and is an easy-to-use, touch-sensitive tool which can be used to manage field instruments throughout their entire life cycle.</p>  <ul style="list-style-type: none"> ▪ Technical Information TI01342S ▪ Operating Instructions BA01709S ▪ Product page: www.endress.com/smt70
Field Xpert SMT77	<p>The Field Xpert SMT77 tablet PC for device configuration enables mobile plant asset management in areas categorized as Ex Zone 1.</p>  <ul style="list-style-type: none"> ▪ Technical Information TI01418S ▪ Operating Instructions BA01923S ▪ Product page: www.endress.com/smt77

Service-specific accessories

Accessory	Description
Applicator	<p>Software for selecting and sizing Endress+Hauser measuring devices:</p> <ul style="list-style-type: none"> ▪ Choice of measuring devices with industrial requirements ▪ Calculation of all the necessary data for identifying the optimum flowmeter: e.g. nominal diameter, pressure loss, flow velocity and accuracy. ▪ Graphic illustration of the calculation results ▪ Determination of the partial order code, administration, documentation and access to all project-related data and parameters over the entire life cycle of a project. <p>Applicator is available:</p> <ul style="list-style-type: none"> ▪ Via the Internet: https://portal.endress.com/webapp/applicator ▪ As a downloadable DVD for local PC installation.
W@M	<p>W@M Life Cycle Management</p> <p>Improved productivity with information at your fingertips. Data relevant to a plant and its components is generated from the first stages of planning and during the asset's complete life cycle.</p> <p>W@M Life Cycle Management is an open and flexible information platform with online and on-site tools. Instant access for your staff to current, in-depth data shortens your plant's engineering time, speeds up procurement processes and increases plant uptime.</p> <p>Combined with the right services, W@M Life Cycle Management boosts productivity in every phase. For more information, see: www.endress.com/lifecyclemanagement</p>
FieldCare	<p>FDT-based plant asset management tool from Endress+Hauser.</p> <p>It can configure all smart field units in your system and helps you manage them. By using the status information, it is also a simple but effective way of checking their status and condition.</p>  <ul style="list-style-type: none"> ▪ Operating Instructions BA00027S and BA00059S
DeviceCare	<p>Tool for connecting and configuring Endress+Hauser field devices.</p>  <ul style="list-style-type: none"> ▪ Innovation brochure IN01047S

System components

Accessories	Description
Memograph M graphic data manager	<p>The Memograph M graphic data manager provides information on all the relevant measured variables. Measured values are recorded correctly, limit values are monitored and measuring points analyzed. The data are stored in the 256 MB internal memory and also on a SD card or USB stick.</p>  <ul style="list-style-type: none"> ▪ Technical Information TI00133R ▪ Operating Instructions BA00247R
iTEMP	<p>The temperature transmitters can be used in all applications and are suitable for the measurement of gases, steam and liquids. They can be used to read in the medium temperature.</p>  <ul style="list-style-type: none"> ▪ "Fields of Activity" document FA00006T

Supplementary documentation



For an overview of the scope of the associated Technical Documentation, refer to the following:

- *Device Viewer* (www.endress.com/deviceviewer): Enter serial number from nameplate.
- *Endress+Hauser Operations app*: Enter serial number from nameplate or scan matrix code on nameplate.

Standard documentation

Brief Operating Instructions

Brief Operating Instructions for the sensor

Measuring device	Documentation code
Proline Promag P	KA01290D

Brief Operating Instructions for the transmitter

Measuring device	Documentation code							PROFINET with Ethernet-APL
	HART	FOUNDATION Fieldbus	PROFIBUS PA	PROFIBUS DP	Modbus RS485	EtherNet/IP	PROFINET	
Proline 500 – digital	KA01313D	KA01292D	KA01407D	KA01388D	KA01317D	KA01343D	KA01349D	KA01519D
Proline 500	KA01312D	KA01293D	KA01406D	KA01387D	KA01316D	KA01342D	KA01348D	KA01518D

Operating Instructions

Measuring device	Documentation code							PROFINET with Ethernet-APL
	HART	FOUNDATION Fieldbus	PROFIBUS PA	PROFIBUS DP	Modbus RS485	EtherNet/IP	PROFINET	
Promag P 500	BA01399D	BA01480D	BA01405D	BA01867D	BA01402D	BA01721D	BA01724D	BA02102D

Description of Device Parameters

Measuring device	Documentation code							PROFINET with Ethernet-APL
	HART	FOUNDATION Fieldbus	PROFIBUS PA	PROFIBUS DP	Modbus RS485	EtherNet/IP	PROFINET	
Promag 500	GP01054D	GP01099D	GP01056D	GP01136D	GP01055D	GP01118D	GP01119D	GP01169D

Supplementary device-dependent documentation

Safety instructions

Safety instructions for electrical equipment for hazardous areas.

Contents	Documentation code
ATEX/IECEX Ex i	XA01522D
ATEX/IECEX Ex ec	XA01523D
cCSAus IS	XA01524D
cCSAus Ex e ia/Ex d ia	XA01525D
cCSAus Ex nA	XA01526D
INMETRO Ex i	XA01527D
INMETRO Ex ec	XA01528D

Contents	Documentation code
NEPSI Ex i	XA01529D
NEPSI Ex nA	XA01530D
EAC Ex i	XA01658D
EAC Ex nA	XA01659D
JPN	XA01776D

Functional Safety Manual

Contents	Documentation code
Promag 500	SD01741D

Special Documentation

Contents	Documentation code
Information on the Pressure Equipment Directive	SD01614D
Radio approvals for WLAN interface for A309/A310 display module	SD01793D
OPC-UA server ¹⁾	SD02044D

1) This Special Documentation is only available for device versions with a HART output.

Contents	Documentation code							
	HART	FOUNDATIO N Fieldbus	PROFIBUS PA	PROFIBUS DP	Modbus RS485	PROFINET	EtherNet/IP	PROFINET with Ethernet- APL
Heartbeat Technology	SD01641D	SD01745D	SD01747D	SD02207D	SD01746D	SD01987D	SD01981D	SD02730D
Web server	SD01658D	SD01661D	SD01660D	SD02236D	SD01659D	SD01979D	SD01978D	SD02760D

Installation Instructions

Contents	Comment
Installation instructions for spare part sets and accessories	Documentation code: specified for each individual accessory → 120.

Registered trademarks

HART®

Registered trademark of the FieldComm Group, Austin, Texas, USA

PROFIBUS®

Registered trademark of the PROFIBUS Nutzerorganisation e.V. (PROFIBUS User Organization), Karlsruhe, Germany

FOUNDATION™ Fieldbus

Registration-pending trademark of the FieldComm Group, Austin, Texas, USA

Modbus®

Registered trademark of SCHNEIDER AUTOMATION, INC.

EtherNet/IP™

Trademark of ODVA, Inc.

Ethernet-APL™

Registered trademark of the PROFIBUS Nutzerorganisation e.V. (PROFIBUS User Organization),
Karlsruhe, Germany

PROFINET®

Registered trademark of the PROFIBUS Nutzerorganisation e.V. (PROFIBUS User Organization),
Karlsruhe, Germany



www.addresses.endress.com
