

Technical Information

Proline Promass P 100

Coriolis flowmeter



Specialist for life sciences with an ultra-compact transmitter

Application

- Measuring principle operates independently of physical fluid properties such as viscosity or density
- Dedicated to applications under sterile conditions in the life sciences industry

Device properties

- ASME BPE, 3-A, EHEDG conform & low delta-ferrite
- Electropolished measuring tube in 1.4435 (316L)
- Fast recovery from CIP/SIP
- Robust, ultra-compact transmitter housing
- Highest degree of protection: IP69K
- Local display available

Your benefits

- Highest process quality – fully compliant to industry requirements
- Fewer process measuring points – multivariable measurement (flow, density, temperature)
- Space-saving installation – no in-/outlet run needs
- Space-saving transmitter – full functionality on smallest footprint
- Time-saving local operation without additional software and hardware – integrated web server
- Integrated verification – Heartbeat Technology





Table of contents

About this document	3	Degree of protection	48
Symbols	3	Vibration- and shock-resistance	48
Function and system design	4	Interior cleaning	48
Measuring principle	4	Electromagnetic compatibility (EMC)	48
Measuring system	6	Process	48
Equipment architecture	7	Medium temperature range	48
Security	7	Density	49
Input	8	Pressure-temperature ratings	49
Measured variable	8	Sensor housing	52
Measuring range	8	Flow limit	53
Operable flow range	8	Pressure loss	53
Input signal	8	System pressure	53
Output	9	Thermal insulation	54
Output signal	9	Heating	54
Signal on alarm	10	Vibrations	54
Ex connection data	12	Mechanical construction	55
Low flow cut off	13	Dimensions in SI units	55
Protocol-specific data	13	Dimensions in US units	76
Power supply	23	Weight	83
Terminal assignment	23	Materials	84
Pin assignment, device plug	30	Process connections	86
Supply voltage	33	Surface roughness	86
Power consumption	33	Operability	86
Current consumption	33	Operating concept	86
Device fuse	33	Local display	87
Power supply failure	34	Remote operation	87
Electrical connection	34	Service interface	89
Potential equalization	38	Certificates and approvals	91
Terminals	38	CE mark	91
Cable entries	39	UKCA marking	92
Cable specification	39	RCM mark	92
Performance characteristics	40	Pressure Equipment Directive	92
Reference operating conditions	40	Other standards and guidelines	92
Maximum measured error	40	Ordering information	93
Repeatability	42	Application packages	93
Response time	42	Heartbeat Technology	93
Influence of ambient temperature	42	Concentration measurement	94
Influence of medium temperature	42	Special density	94
Influence of medium pressure	43	Accessories	94
Design fundamentals	43	Device-specific accessories	94
Mounting	44	Communication-specific accessories	95
Mounting location	44	Service-specific accessories	96
Orientation	45	System components	96
Inlet and outlet runs	46	Supplementary documentation	96
Special mounting instructions	46	Standard documentation	97
Installing the Safety Barrier Promass 100	47	Supplementary device-dependent documentation	97
Environment	47	Registered trademarks	98
Ambient temperature range	47		
Storage temperature	47		
Climate class	48		









About this document

Symbols





Electrical symbols

Symbol	Meaning
	Direct current
	Alternating current
	Direct current and alternating current
	Ground connection A grounded terminal which, as far as the operator is concerned, is grounded via a grounding system.
	Potential equalization connection (PE: protective earth) Ground terminals that must be connected to ground prior to establishing any other connections. The ground terminals are located on the interior and exterior of the device: <ul style="list-style-type: none"> ▪ Interior ground terminal: potential equalization is connected to the supply network. ▪ Exterior ground terminal: device is connected to the plant grounding system.

Symbols for certain types of information

Symbol	Meaning
	Permitted Procedures, processes or actions that are permitted.
	Preferred Procedures, processes or actions that are preferred.
	Forbidden Procedures, processes or actions that are forbidden.
	Tip Indicates additional information.
	Reference to documentation
	Reference to page
	Reference to graphic
	Visual inspection

Symbols in graphics

Symbol	Meaning
1, 2, 3, ...	Item numbers
	Series of steps
A, B, C, ...	Views
A-A, B-B, C-C, ...	Sections
	Hazardous area
	Safe area (non-hazardous area)
	Flow direction

Function and system design

Measuring principle

The measuring principle is based on the controlled generation of Coriolis forces. These forces are always present in a system when both translational and rotational movements are superimposed.

$$F_c = 2 \cdot \Delta m (v \cdot \omega)$$

F_c = Coriolis force

Δm = moving mass

ω = rotational velocity

v = radial velocity in rotating or oscillating system

The amplitude of the Coriolis force depends on the moving mass Δm , its velocity v in the system and thus on the mass flow. Instead of a constant rotational velocity ω , the sensor uses oscillation.

In the sensor, an oscillation is produced in the measuring tube. The Coriolis forces produced at the measuring tube cause a phase shift in the tube oscillations (see illustration):

- If there is zero flow (i.e. when the fluid stands still), the oscillation measured at points A and B has the same phase (no phase difference) (1).
- Mass flow causes deceleration of the oscillation at the inlet of the tubes (2) and acceleration at the outlet (3).

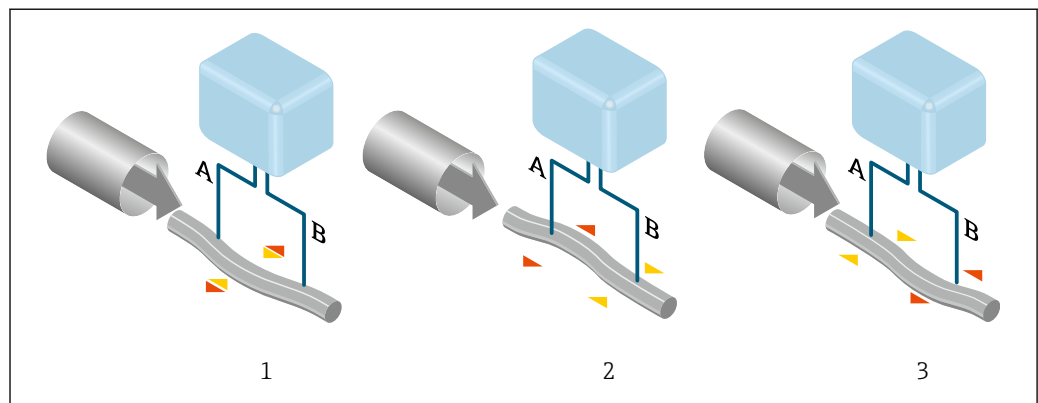

A0029932

The phase difference (A-B) increases with increasing mass flow. Electrodynamic sensors register the tube oscillations at the inlet and outlet. System balance is ensured by the antiphase oscillation of an eccentrically arranged swinging mass. The measuring principle operates independently of temperature, pressure, viscosity, conductivity and flow profile.

Density measurement

The measuring tube is continuously excited at its resonance frequency. A change in the mass and thus the density of the oscillating system (comprising measuring tube and fluid) results in a corresponding, automatic adjustment in the oscillation frequency. The resonance frequency is thus a function of the medium density. The microprocessor utilizes this relationship to obtain a density signal.

Volume measurement

Together with the measured mass flow, this is used to calculate the volume flow.

Temperature measurement

The temperature of the measuring tube is determined in order to calculate the compensation factor due to temperature effects. This signal corresponds to the process temperature and is also available as an output signal.

Gas Fraction Handler (GFH)

The Gas Fraction Handler is a Promass software function that improves measurement stability and repeatability. The function continuously checks for the presence of disturbances in single-phase flow, i.e. gas bubbles in liquids or droplets in gas. In the presence of the second phase, flow and density become increasingly unstable. The Gas Fraction Handler function improves measurement stability

with respect to the severity of the disturbances, without any effect under single-phase flow conditions.



The Gas Fraction Handler is only available in device versions with HART, Modbus RS485, PROFINET and PROFINET with Ethernet-APL.



For detailed information on the Gas Fraction Handler, see the Special Documentation for "Gas Fraction Handler"

Measuring system

The device consists of a transmitter and a sensor. If a device with Modbus RS485 intrinsically safe is ordered, the Safety Barrier Promass 100 is part of the scope of supply and must be implemented to operate the device.

The device is available as a compact version:
The transmitter and sensor form a mechanical unit.

Transmitter

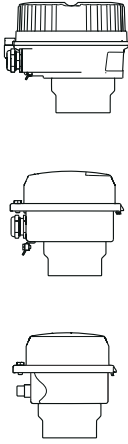
<p>Proline 100</p>  <p>A0016693</p> <p>A0016694</p> <p>A0016695</p>	<p>Device versions and materials:</p> <ul style="list-style-type: none"> ▪ Compact, aluminum, coated: Aluminum, AlSi10Mg, coated ▪ Compact, hygienic, stainless: Hygienic version, stainless steel 1.4301 (304) ▪ Ultra-compact, hygienic, stainless: Hygienic version, stainless steel 1.4301 (304) <p>Configuration:</p> <ul style="list-style-type: none"> ▪ Via operating tools (e.g. FieldCare, DeviceCare) ▪ Also for device version with local display (LCD): Via web browser (e.g. Microsoft Internet Explorer) ▪ Also for device version with 4-20 mA HART, pulse/frequency/switch output: Via web browser (e.g. Microsoft Internet Explorer) ▪ Also for device version with EtherNet/IP output: <ul style="list-style-type: none"> ▪ Via web browser (e.g. Microsoft Internet Explorer) ▪ Via Add-on Profile Level 3 for automation system from Rockwell Automation ▪ Via Electronic Data Sheet (EDS) ▪ Also for device version with PROFINET output: <ul style="list-style-type: none"> ▪ Via web browser (e.g. Microsoft Internet Explorer) ▪ Via device master file (GSD)
---	---

Sensor

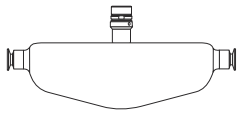
<p>Promass P</p>  <p>A0016509</p>	<ul style="list-style-type: none"> ▪ Bent single-tube system ▪ For use in sterile applications in heavily regulated industries ▪ Nominal diameter range: DN 8 to 50 (3/8 to 2") ▪ Materials: <ul style="list-style-type: none"> ▪ Sensor: stainless steel, 1.4301 (304) ▪ Measuring tubes: stainless steel, 1.4435 BN2 (316L) ▪ Process connections: stainless steel, 1.4435 BN2 (316L); 1.4404 (F316/F316L) ▪ Surface quality: Ra_{max} 0.76 µm (30 µin) Ra_{max} 0.38 µm (15 µin) (electropolished) ▪ Delta ferrite <1%
---	--

Safety Barrier Promass 100

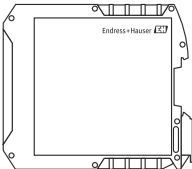
 <p>A0016763</p>	<ul style="list-style-type: none"> ▪ Dual-channel safety barrier for installation in non-hazardous locations or zone 2/div. 2: <ul style="list-style-type: none"> ▪ Channel 1: DC 24 V power supply ▪ Channel 2: Modbus RS485 ▪ In addition to current, voltage and power limitation, it offers galvanic isolation of circuits for explosion protection. ▪ Easy top-hat rail mounting (DIN 35 mm) for installation in control cabinets
---	--

Equipment architecture

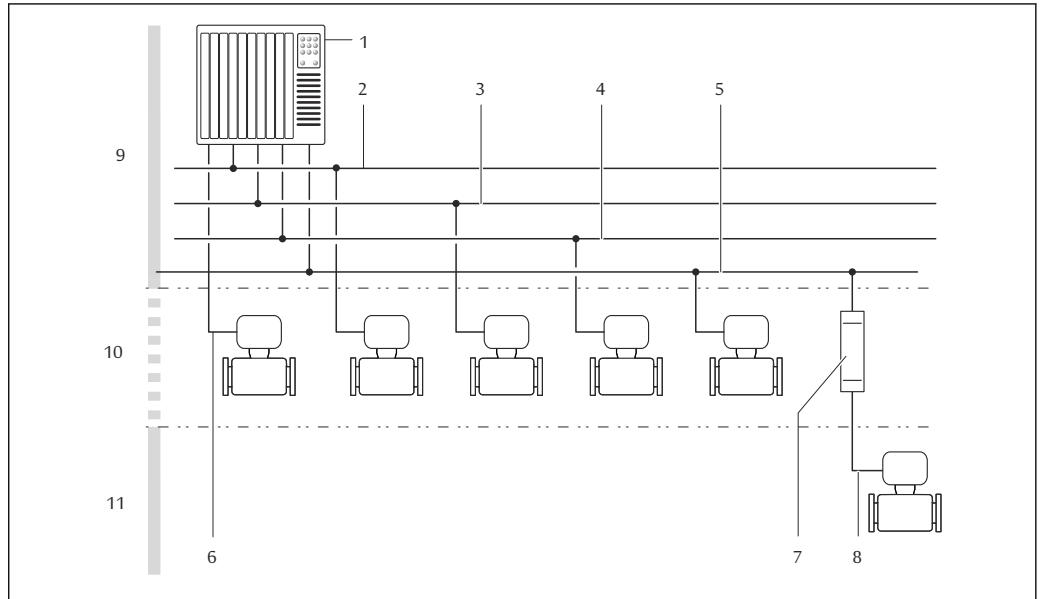

A0016779

1 Possibilities for integrating measuring devices into a system

- 1 Control system (e.g. PLC)
- 2 EtherNet/IP
- 3 PROFIBUS DP
- 4 PROFINET
- 5 Modbus RS485
- 6 4-20 mA HART, pulse/frequency/switch output
- 7 Safety Barrier Promass 100
- 8 Modbus RS485 intrinsically safe
- 9 Non-hazardous area
- 10 Non-hazardous area and Zone 2/Div. 2
- 11 Hazardous area and Zone 1/Div. 1

Security

IT security

Our warranty is valid only if the product is installed and used as described in the Operating Instructions. The product is equipped with security mechanisms to protect it against any inadvertent changes to the settings.

IT security measures, which provide additional protection for the product and associated data transfer, must be implemented by the operators themselves in line with their security standards.

Input

Measured variable

Direct measured variables

- Mass flow
- Density
- Temperature

Calculated measured variables



- Volume flow
- Corrected volume flow
- Reference density

Measuring range

Measuring range for liquids

DN		Measuring range full scale values $\dot{m}_{\min(F)}$ to $\dot{m}_{\max(F)}$	
[mm]	[in]	[kg/h]	[lb/min]
8	$\frac{3}{8}$	0 to 2 000	0 to 73.50
15	$\frac{1}{2}$	0 to 6 500	0 to 238.9
25	1	0 to 18 000	0 to 661.5
40	$1\frac{1}{2}$	0 to 45 000	0 to 1 654
50	2	0 to 70 000	0 to 2 573

Recommended measuring range

 Flow limit →  53

Operable flow range

Over 1000 : 1.

Flow rates above the preset full scale value do not override the electronics unit, with the result that the totalizer values are registered correctly.

Input signal

External measured values

To increase the accuracy of certain measured variables or to calculate the corrected volume flow for gases, the automation system can continuously write different measured values to the measuring device:

- Operating pressure to increase accuracy (Endress+Hauser recommends the use of a pressure measuring device for absolute pressure, e.g. Cerabar M or Cerabar S)
- Medium temperature to increase accuracy (e.g. iTEMP)
- Reference density for calculating the corrected volume flow for gases

 Various pressure transmitters and temperature measuring devices can be ordered from Endress +Hauser: see "Accessories" section →  96

It is recommended to read in external measured values to calculate the following measured variables:

- Mass flow
- Corrected volume flow

HART protocol

The measured values are written from the automation system to the measuring device via the HART protocol. The pressure transmitter must support the following protocol-specific functions:

- HART protocol
- Burst mode

Digital communication

The measured values can be written by the automation system via:

- PROFIBUS DP
- Modbus RS485
- EtherNet/IP
- PROFINET

Output



Output signal

HART current output

Current output	4-20 mA HART (active)
Maximum output values	<ul style="list-style-type: none"> ■ DC 24 V (no flow) ■ 22.5 mA
Load	0 to 700 Ω
Resolution	0.38 µA
Damping	Configurable: 0.07 to 999 s
Assignable measured variables	<ul style="list-style-type: none"> ■ Mass flow ■ Volume flow ■ Corrected volume flow ■ Density ■ Reference density ■ Temperature <p> The range of options increases if the measuring device has one or more application packages.</p>

Pulse/frequency/switch output

Function	Can be set to pulse, frequency or switch output
Version	Passive, open collector
Maximum input values	<ul style="list-style-type: none"> ■ DC 30 V ■ 25 mA
Voltage drop	For 25 mA: ≤ DC 2 V
Pulse output	
Pulse width	Configurable: 0.05 to 2 000 ms
Maximum pulse rate	10 000 Impulse/s
Pulse value	Adjustable
Assignable measured variables	<ul style="list-style-type: none"> ■ Mass flow ■ Volume flow ■ Corrected volume flow
Frequency output	
Output frequency	Configurable: 0 to 10 000 Hz
Damping	Configurable: 0 to 999 s
Pulse/pause ratio	1:1

Assignable measured variables	<ul style="list-style-type: none"> ▪ Mass flow ▪ Volume flow ▪ Corrected volume flow ▪ Density ▪ Reference density ▪ Temperature <p> The range of options increases if the measuring device has one or more application packages.</p>
Switch output	
Switching behavior	Binary, conductive or non-conductive
Switching delay	Configurable: 0 to 100 s
Number of switching cycles	Unlimited
Assignable functions	<ul style="list-style-type: none"> ▪ Off ▪ On ▪ Diagnostic behavior ▪ Limit value <ul style="list-style-type: none"> ▪ Mass flow ▪ Volume flow ▪ Corrected volume flow ▪ Density ▪ Reference density ▪ Temperature ▪ Totalizer 1-3 ▪ Flow direction monitoring ▪ Status <ul style="list-style-type: none"> ▪ Partially filled pipe detection ▪ Low flow cut off <p> The range of options increases if the measuring device has one or more application packages.</p>

PROFIBUS DP

Signal encoding	NRZ code
Data transfer	9.6 kBaud...12 MBaud
Terminating resistor	Integrated, can be activated via DIP switches

Modbus RS485

Physical interface	In accordance with EIA/TIA-485-A standard
Terminating resistor	<ul style="list-style-type: none"> ▪ For device version used in non-hazardous areas or Zone 2/Div. 2: integrated and can be activated via DIP switches on the transmitter electronics module ▪ For device version used in intrinsically safe areas: integrated and can be activated via DIP switches on the Safety Barrier Promass 100

EtherNet/IP

Standards	In accordance with IEEE 802.3
------------------	-------------------------------

PROFINET

Standards	In accordance with IEEE 802.3
------------------	-------------------------------

Signal on alarm

Depending on the interface, failure information is displayed as follows:

Current output 4 to 20 mA

4 to 20 mA

Failure mode	Choose from: <ul style="list-style-type: none"> ▪ 4 to 20 mA in accordance with NAMUR recommendation NE 43 ▪ 4 to 20 mA in accordance with US ▪ Min. value: 3.59 mA ▪ Max. value: 22.5 mA ▪ Definable value between: 3.59 to 22.5 mA ▪ Actual value ▪ Last valid value
---------------------	---

Pulse/frequency/switch output

Pulse output	
Failure mode	Choose from: <ul style="list-style-type: none"> ▪ Actual value ▪ No pulses
Frequency output	
Failure mode	Choose from: <ul style="list-style-type: none"> ▪ Actual value ▪ 0 Hz ▪ Definable value between: 0 to 12 500 Hz
Switch output	
Failure mode	Choose from: <ul style="list-style-type: none"> ▪ Current status ▪ Open ▪ Closed

PROFIBUS DP

Status and alarm messages	Diagnostics in accordance with PROFIBUS PA Profile 3.02
----------------------------------	---

Modbus RS485

Failure mode	Choose from: <ul style="list-style-type: none"> ▪ NaN value instead of current value ▪ Last valid value
---------------------	---

EtherNet/IP

Device diagnostics	Device condition can be read out in Input Assembly
---------------------------	--

PROFINET

Device diagnostics	According to "Application Layer protocol for decentralized periphery", Version 2.3
---------------------------	--

Local display

Plain text display	With information on cause and remedial measures
Backlight	Red backlighting indicates a device error.



Status signal as per NAMUR recommendation NE 107

Interface/protocol

- Via digital communication:
 - HART protocol
 - PROFIBUS DP
 - Modbus RS485
 - EtherNet/IP
 - PROFINET
- Via service interface
CDI-RJ45 service interface

Plain text display	With information on cause and remedial measures
---------------------------	---



Additional information on remote operation → 87

Web browser

Plain text display	With information on cause and remedial measures
---------------------------	---

Light emitting diodes (LED)

Status information	<p>Status indicated by various light emitting diodes</p> <p>The following information is displayed depending on the device version:</p> <ul style="list-style-type: none"> ▪ Supply voltage active ▪ Data transmission active ▪ Device alarm/error has occurred ▪ EtherNet/IP network available ▪ EtherNet/IP connection established ▪ PROFINET network available ▪ PROFINET connection established ▪ PROFINET blinking feature
---------------------------	---

Ex connection data

These values only apply for the following device version:
Order code for "Output", option M "Modbus RS485", for use in intrinsically safe areas

Safety Barrier Promass 100*Safety-related values*

Terminal numbers			
Supply voltage		Signal transmission	
2 (L-)	1 (L+)	26 (B)	27 (A)
$U_{\text{nom}} = \text{DC } 24 \text{ V}$ $U_{\text{max}} = \text{AC } 260 \text{ V}$		$U_{\text{nom}} = \text{DC } 5 \text{ V}$ $U_{\text{max}} = \text{AC } 260 \text{ V}$	

Intrinsically safe values

Terminal numbers			
Supply voltage		Signal transmission	
20 (L-)	10 (L+)	62 (B)	72 (A)
$U_o = 16.24 \text{ V}$ $I_o = 623 \text{ mA}$ $P_o = 2.45 \text{ W}$ With IIC ¹⁾ : $L_o = 92.8 \text{ } \mu\text{H}$, $C_o = 0.433 \text{ } \mu\text{F}$, $L_o/R_o = 14.6 \text{ } \mu\text{H}/\Omega$ With IIB: $L_o = 372 \text{ } \mu\text{H}$, $C_o = 2.57 \text{ } \mu\text{F}$, $L_o/R_o = 58.3 \text{ } \mu\text{H}/\Omega$			
 For an overview and for information on the interdependencies between the gas group - sensor - nominal diameter, see the "Safety Instructions" (XA) document for the measuring device			

1) The gas group depends on the sensor and nominal diameter ff.

Transmitter

Intrinsically safe values

Order code "Approval"	Terminal numbers			
	Supply voltage		Signal transmission	
	20 (L-)	10 (L+)	62 (B)	72 (A)
<ul style="list-style-type: none"> ▪ Option BM: ATEX II2G + IECEx Z1 Ex ia, II2D Ex tb ▪ Option BO: ATEX II1/2G + IECEx Z0/Z1 Ex ia, II2D ▪ Option BQ: ATEX II1/2G + IECEx Z0/Z1 Ex ia ▪ Option BU: ATEX II2G + IECEx Z1 Ex ia ▪ Option C2: CSA C/US IS Cl. I, II, III Div. 1 ▪ Option 85: ATEX II2G + IECEx Z1 Ex ia + CSA C/US IS Cl. I, II, III Div. 1 	$U_i = 16.24 \text{ V}$ $I_i = 623 \text{ mA}$ $P_i = 2.45 \text{ W}$ $L_i = 0 \text{ } \mu\text{H}$ $C_i = 6 \text{ nF}$			
 For an overview and for information on the interdependencies between the gas group - sensor - nominal diameter, see the "Safety Instructions" (XA) document for the measuring device				

Low flow cut off

The switch points for low flow cut off are user-selectable.

Protocol-specific data

HART

Manufacturer ID	0x11
Device type ID	0x4A
HART protocol revision	7
Device description files (DTM, DD)	Information and files under: www.endress.com
HART load	Min. 250 Ω

Dynamic variables	<p>Read out the dynamic variables: HART command 3 The measured variables can be freely assigned to the dynamic variables.</p> <p>Measured variables for PV (primary dynamic variable)</p> <ul style="list-style-type: none"> ▪ Mass flow ▪ Volume flow ▪ Corrected volume flow ▪ Density ▪ Reference density ▪ Temperature <p>Measured variables for SV, TV, QV (secondary, tertiary and quaternary dynamic variable)</p> <ul style="list-style-type: none"> ▪ Mass flow ▪ Volume flow ▪ Corrected volume flow ▪ Density ▪ Reference density ▪ Temperature ▪ Totalizer 1 ▪ Totalizer 2 ▪ Totalizer 3 <p> The range of options increases if the measuring device has one or more application packages.</p> <p>Heartbeat Technology application package Additional measured variables are available with the Heartbeat Technology application package:</p> <ul style="list-style-type: none"> ▪ Carrier pipe temperature ▪ Oscillation amplitude 0
Device variables	<p>Read out the device variables: HART command 9 The device variables are permanently assigned.</p> <p>A maximum of 8 device variables can be transmitted:</p> <ul style="list-style-type: none"> ▪ 0 = mass flow ▪ 1 = volume flow ▪ 2 = corrected volume flow ▪ 3 = density ▪ 4 = reference density ▪ 5 = temperature ▪ 6 = totalizer 1 ▪ 7 = totalizer 2 ▪ 8 = totalizer 3 ▪ 13 = target mass flow ▪ 14 = carrier mass flow ▪ 15 = concentration

PROFIBUS DP

Manufacturer ID	0x11
Ident number	0x1561
Profile version	3.02
Device description files (GSD, DTM, DD)	<p>Information and files at:</p> <ul style="list-style-type: none"> ▪ https://www.endress.com/download On the device product page: PRODUCTS → Product Finder → Links ▪ https://www.profibus.com

<p>Output values (from measuring device to automation system)</p>	<p>Analog input 1 to 8</p> <ul style="list-style-type: none"> ▪ Mass flow ▪ Volume flow ▪ Corrected volume flow ▪ Target mass flow ▪ Carrier mass flow ▪ Density ▪ Reference density ▪ Concentration ▪ Temperature ▪ Carrier pipe temperature ▪ Electronics temperature ▪ Oscillation frequency ▪ Oscillation amplitude ▪ Frequency fluctuation ▪ Oscillation damping ▪ Tube damping fluctuation ▪ Signal asymmetry ▪ Exciter current <p>Digital input 1 to 2</p> <ul style="list-style-type: none"> ▪ Partially filled pipe detection ▪ Low flow cut off <p>Totalizer 1 to 3</p> <ul style="list-style-type: none"> ▪ Mass flow ▪ Volume flow ▪ Corrected volume flow
<p>Input values (from automation system to measuring device)</p>	<p>Analog output 1 to 3 (fixed assignment)</p> <ul style="list-style-type: none"> ▪ Pressure ▪ Temperature ▪ Reference density <p>Digital output 1 to 3 (fixed assignment)</p> <ul style="list-style-type: none"> ▪ Digital output 1: switch positive zero return on/off ▪ Digital output 2: perform zero adjustment ▪ Digital output 3: switch switch output on/off <p>Totalizer 1 to 3</p> <ul style="list-style-type: none"> ▪ Totalize ▪ Reset and hold ▪ Preset and hold ▪ Stop ▪ Operating mode configuration: <ul style="list-style-type: none"> ▪ Net flow total ▪ Forward flow total ▪ Reverse flow total
<p>Supported functions</p>	<ul style="list-style-type: none"> ▪ Identification & Maintenance Simplest device identification on the part of the control system and nameplate ▪ PROFIBUS upload/download Reading and writing parameters is up to ten times faster with PROFIBUS upload/download ▪ Condensed Status Simplest and self-explanatory diagnostic information by categorizing diagnostic messages that occur
<p>Configuration of the device address</p>	<ul style="list-style-type: none"> ▪ DIP switches on the I/O electronics module ▪ Via operating tools (e.g. FieldCare)

Modbus RS485

<p>Protocol</p>	<p>Modbus Applications Protocol Specification V1.1</p>
<p>Device type</p>	<p>Slave</p>
<p>Slave address range</p>	<p>1 to 247</p>
<p>Broadcast address range</p>	<p>0</p>

Function codes	<ul style="list-style-type: none"> ▪ 03: Read holding register ▪ 04: Read input register ▪ 06: Write single registers ▪ 08: Diagnostics ▪ 16: Write multiple registers ▪ 23: Read/write multiple registers
Broadcast messages	Supported by the following function codes: <ul style="list-style-type: none"> ▪ 06: Write single registers ▪ 16: Write multiple registers ▪ 23: Read/write multiple registers
Supported baud rate	<ul style="list-style-type: none"> ▪ 1 200 BAUD ▪ 2 400 BAUD ▪ 4 800 BAUD ▪ 9 600 BAUD ▪ 19 200 BAUD ▪ 38 400 BAUD ▪ 57 600 BAUD ▪ 115 200 BAUD
Data transfer mode	<ul style="list-style-type: none"> ▪ ASCII ▪ RTU
Data access	Each device parameter can be accessed via Modbus RS485.  For Modbus register information, see "Description of device parameters" documentation

EtherNet/IP

Protocol	<ul style="list-style-type: none"> ▪ The CIP Networks Library Volume 1: Common Industrial Protocol ▪ The CIP Networks Library Volume 2: EtherNet/IP Adaptation of CIP
Communication type	<ul style="list-style-type: none"> ▪ 10Base-T ▪ 100Base-TX
Device profile	Generic device (product type: 0x2B)
Manufacturer ID	0x49E
Device type ID	0x104A
Baud rates	Automatic ¹⁰ / ₁₀₀ Mbit with half-duplex and full-duplex detection
Polarity	Auto-polarity for automatic correction of crossed TxD and RxD pairs
Supported CIP connections	Max. 3 connections
Explicit connections	Max. 6 connections
I/O connections	Max. 6 connections (scanner)
Configuration options for measuring device	<ul style="list-style-type: none"> ▪ DIP switches on the electronics module for IP addressing ▪ Manufacturer-specific software (FieldCare) ▪ Add-on Profile Level 3 for Rockwell Automation control systems ▪ Web browser ▪ Electronic Data Sheet (EDS) integrated in the measuring device
Configuration of the EtherNet interface	<ul style="list-style-type: none"> ▪ Speed: 10 MBit, 100 MBit, auto (factory setting) ▪ Duplex: half-duplex, full-duplex, auto (factory setting)
Configuration of the device address	<ul style="list-style-type: none"> ▪ DIP switches on the electronics module for IP addressing (last octet) ▪ DHCP ▪ Manufacturer-specific software (FieldCare) ▪ Add-on Profile Level 3 for Rockwell Automation control systems ▪ Web browser ▪ EtherNet/IP tools, e.g. RSLinx (Rockwell Automation)
Device Level Ring (DLR)	No

Fix Input			
RPI	5 ms to 10 s (factory setting: 20 ms)		
Exclusive Owner Multicast		Instance	Size [byte]
	Instance configuration:	0x68	398
	O → T configuration:	0x66	64
	T → O configuration:	0x64	44
Exclusive Owner Multicast		Instance	Size [byte]
	Instance configuration:	0x69	-
	O → T configuration:	0x66	64
	T → O configuration:	0x64	44
Input only Multicast		Instance	Size [byte]
	Instance configuration:	0x68	398
	O → T configuration:	0xC7	-
	T → O configuration:	0x64	44
Input only Multicast		Instance	Size [byte]
	Instance configuration:	0x69	-
	O → T configuration:	0xC7	-
	T → O configuration:	0x64	44
Input Assembly	<ul style="list-style-type: none"> ■ Current device diagnostics ■ Mass flow ■ Volume flow ■ Corrected volume flow ■ Density ■ Reference density ■ Temperature ■ Totalizer 1 ■ Totalizer 2 ■ Totalizer 3 		
Configurable Input			
RPI	5 ms to 10 s (factory setting: 20 ms)		
Exclusive Owner Multicast		Instance	Size [byte]
	Instance configuration:	0x68	398
	O → T configuration:	0x66	64
	T → O configuration:	0x65	88
Exclusive Owner Multicast		Instance	Size [byte]
	Instance configuration:	0x69	-
	O → T configuration:	0x66	64
	T → O configuration:	0x65	88
Input only Multicast		Instance	Size [byte]
	Instance configuration:	0x68	398
	O → T configuration:	0xC7	-
	T → O configuration:	0x65	88
Input only Multicast		Instance	Size [byte]
	Instance configuration:	0x69	-
	O → T configuration:	0xC7	-
	T → O configuration:	0x65	88

Configurable Input Assembly	<ul style="list-style-type: none"> ▪ Current device diagnostics ▪ Mass flow ▪ Volume flow ▪ Corrected volume flow ▪ Density ▪ Reference density ▪ Temperature ▪ Totalizer 1 ▪ Totalizer 2 ▪ Totalizer 3 <p> The range of options increases if the measuring device has one or more application packages.</p>
Fix Output	
Output Assembly	<ul style="list-style-type: none"> ▪ Activation of reset totalizers 1-3 ▪ Activation of pressure compensation ▪ Activation of reference density compensation ▪ Activation of temperature compensation ▪ Reset totalizers 1-3 ▪ External pressure value ▪ Pressure unit ▪ External reference density ▪ Reference density unit ▪ External temperature ▪ Temperature unit
Configuration	
Configuration Assembly	<p>Only the most common configurations are listed below.</p> <ul style="list-style-type: none"> ▪ Software write protection ▪ Mass flow unit ▪ Mass unit ▪ Volume flow unit ▪ Volume unit ▪ Corrected volume flow unit ▪ Corrected volume unit ▪ Density unit ▪ Reference density unit ▪ Temperature unit ▪ Pressure unit ▪ Length ▪ Totalizer 1-3: <ul style="list-style-type: none"> ▪ Assignment ▪ Unit ▪ Operating mode ▪ Failure mode ▪ Alarm delay

PROFINET

Protocol	"Application layer protocol for decentral device periphery and distributed automation", version 2.3
Conformance Class	B
Communication type	100 MBit/s
Device profile	Application interface identifier 0xF600 Generic device
Manufacturer ID	0x11
Device type ID	0x844A
Device description files (GSD, DTM)	Information and files at: <ul style="list-style-type: none"> ▪ https://www.endress.com/download On the device product page: PRODUCTS → Product Finder → Links ▪ https://www.profibus.com
Baud rates	Automatic 100 Mbit/s with full-duplex detection

Cycle times	From 8 ms
Polarity	Auto-polarity for automatic correction of crossed TxD and RxD pairs
Supported connections	<ul style="list-style-type: none"> ▪ 1 x AR (Application Relation) ▪ 1 x Input CR (Communication Relation) ▪ 1 x Output CR (Communication Relation) ▪ 1 x Alarm CR (Communication Relation)
Configuration options for measuring device	<ul style="list-style-type: none"> ▪ DIP switches on the electronics module, for device name assignment (last part) ▪ Manufacturer-specific software (FieldCare, DeviceCare) ▪ Web browser ▪ Device master file (GSD), can be read out via the integrated web server of the measuring device
Configuration of the device name	<ul style="list-style-type: none"> ▪ DIP switches on the electronics module, for device name assignment (last part) ▪ DCP protocol
Output values (from measuring device to automation system)	<p>Analog Input module (slot 1 to 14)</p> <ul style="list-style-type: none"> ▪ Mass flow ▪ Volume flow ▪ Corrected volume flow ▪ Target mass flow ▪ Carrier mass flow ▪ Density ▪ Reference density ▪ Concentration ▪ Temperature ▪ Carrier pipe temperature ▪ Electronics temperature ▪ Oscillation frequency ▪ Oscillation amplitude ▪ Frequency fluctuation ▪ Oscillation damping ▪ Tube damping fluctuation ▪ Signal asymmetry ▪ Exciter current <p>Discrete Input module (slot 1 to 14)</p> <ul style="list-style-type: none"> ▪ Empty pipe detection ▪ Low flow cut off <p>Diagnostics Input module (slot 1 to 14)</p> <ul style="list-style-type: none"> ▪ Previous diagnostics ▪ Actual diagnostics <p>Totalizer 1 to 3 (slot 15 to 17)</p> <ul style="list-style-type: none"> ▪ Mass flow ▪ Volume flow ▪ Corrected volume flow <p>Heartbeat Verification module (fixed assignment) Verification status (slot 23)</p> <p> The range of options increases if the measuring device has one or more application packages.</p>

<p>Input values (from automation system to measuring device)</p>	<p>Analog Output module (fixed assignment)</p> <ul style="list-style-type: none"> ▪ External pressure (slot 18) ▪ External temperature (slot 19) ▪ External reference density (slot 20) <p>Discrete Output module (fixed assignment)</p> <ul style="list-style-type: none"> ▪ Activate/deactivate positive zero return (slot 21) ▪ Perform zero adjustment (slot 22) <p>Totalizer 1 to 3 (slot 15 to 17)</p> <ul style="list-style-type: none"> ▪ Totalize ▪ Reset and hold ▪ Preset and hold ▪ Stop ▪ Operating mode configuration: <ul style="list-style-type: none"> ▪ Net flow total ▪ Forward flow total ▪ Reverse flow total <p>Heartbeat Verification module (fixed assignment) Start verification (slot 23)</p> <p> The range of options increases if the measuring device has one or more application packages.</p>
<p>Supported functions</p>	<ul style="list-style-type: none"> ▪ Identification & Maintenance Simple device identification via: <ul style="list-style-type: none"> ▪ Control system ▪ Nameplate ▪ Measured value status The process variables are communicated with a measured value status ▪ Blinking feature via the local display for simple device identification and assignment

Administration of software options

Input/output value	Process variable	Category	Slot
Output value	Mass flow	Process variable	1...14
	Volume flow		
	Corrected volume flow		
	Density		
	Reference density		
	Temperature		
	Electronics temperature		
	Oscillation frequency		
	Frequency fluctuation		
	Oscillation damping		
	Oscillation frequency		
	Signal asymmetry		
	Exciter current		
	Empty pipe detection		
	Low flow cut off		
Current device diagnostics			
Previous device diagnostics			
Output value	Target mass flow	Concentration ¹⁾	1...14
	Carrier mass flow		
	Concentration		
Output value	Carrier pipe temperature	Heartbeat ²⁾	1...14

Input/output value	Process variable	Category	Slot
	Oscillation damping 1		
	Oscillation frequency 1		
	Oscillation amplitude 0		
	Oscillation amplitude 1		
	Frequency fluctuation 1		
	Tube damping fluctuation 1		
	Exciter current 1		
Input value	External density	Process monitoring	18
	External temperature		19
	External reference density		20
	Flow override		21
	Zero adjust		22
	Verification status	Heartbeat Verification ²⁾	23

- 1) Only available with the "Concentration" application package.
- 2) Only available with the "Heartbeat" application package.

Startup configuration

Startup configuration (NSU)	<p>If startup configuration is enabled, the configuration of the most important device parameters is taken from the automation system and used.</p> <p>The following configuration is taken from the automation system:</p> <ul style="list-style-type: none"> ▪ Management <ul style="list-style-type: none"> ▪ Software revision ▪ Write protection ▪ System units <ul style="list-style-type: none"> ▪ Mass flow ▪ Mass ▪ Volume flow ▪ Volume ▪ Corrected volume flow ▪ Corrected volume ▪ Density ▪ Reference density ▪ Temperature ▪ Pressure ▪ Concentration application package <ul style="list-style-type: none"> ▪ Coefficients A0 to A4 ▪ Coefficients B1 to B3 ▪ Sensor adjustment ▪ Process parameters <ul style="list-style-type: none"> ▪ Damping (flow, density, temperature) ▪ Flow override ▪ Low flow cut off <ul style="list-style-type: none"> ▪ Assign process variable ▪ Switch-on/switch-off point ▪ Pressure shock suppression ▪ Empty pipe detection <ul style="list-style-type: none"> ▪ Assign process variable ▪ Limits ▪ Response time ▪ Max. damping ▪ Corrected volume flow calculation <ul style="list-style-type: none"> ▪ External reference density ▪ Fixed reference density ▪ Reference temperature ▪ Linear expansion coefficient ▪ Square expansion coefficient ▪ Measuring mode <ul style="list-style-type: none"> ▪ Medium ▪ Gas type ▪ Reference sound velocity ▪ Temperature coefficient sound velocity ▪ External compensation <ul style="list-style-type: none"> ▪ Pressure compensation ▪ Pressure value ▪ External pressure ▪ Diagnostic settings ▪ Diagnostic behavior for diverse diagnostic information
-----------------------------	--

Power supply

Terminal assignment

Overview: housing version and connection versions

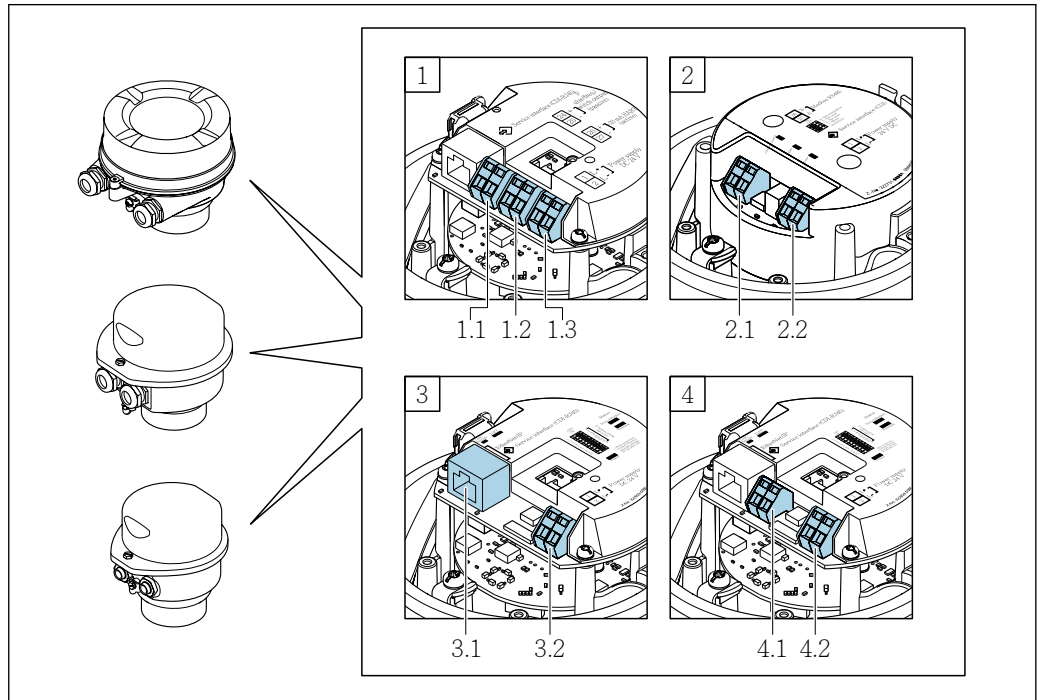

A0016770

- A Housing version: compact, aluminum coated
- B Housing version: compact, hygienic, stainless
- C Housing version: ultra-compact, hygienic, stainless
- 1 Connection version: 4-20 mA HART, pulse/frequency/switch output
 - 1.1 Signal transmission: pulse/frequency/switch output
 - 1.2 Signal transmission: 4-20 mA HART
 - 1.3 Supply voltage
- 2 Connection version: Modbus RS485
 - 2.1 Signal transmission
 - 2.2 Supply voltage
- 3 Connection versions: EtherNet/IP and PROFINET
 - 3.1 Signal transmission
 - 3.2 Supply voltage
- 4 Connection version: PROFIBUS DP
 - 4.1 Signal transmission
 - 4.2 Supply voltage

Transmitter

Connection version 4-20 mA HART with pulse/frequency/switch output

Order code for "Output", option **B**

Depending on the housing version, the transmitters can be ordered with terminals or device plugs.

Order code "Housing"	Connection methods available		Possible options for order code "Electrical connection"
	Outputs	Power supply	
Options A, B	Terminals	Terminals	<ul style="list-style-type: none"> ▪ Option A: coupling M20x1 ▪ Option B: thread M20x1 ▪ Option C: thread G ½" ▪ Option D: thread NPT ½"
Options A, B	Device plugs → 31	Terminals	<ul style="list-style-type: none"> ▪ Option L: plug M12x1 + thread NPT ½" ▪ Option N: plug M12x1 + coupling M20 ▪ Option P: plug M12x1 + thread G ½" ▪ Option U: plug M12x1 + thread M20
Options A, B, C	Device plugs → 31	Device plugs → 31	Option Q: 2 x plug M12x1
Order code for "Housing": <ul style="list-style-type: none"> ▪ Option A: compact, coated aluminum ▪ Option B: compact, hygienic, stainless ▪ Option C: ultra-compact, hygienic, stainless 			

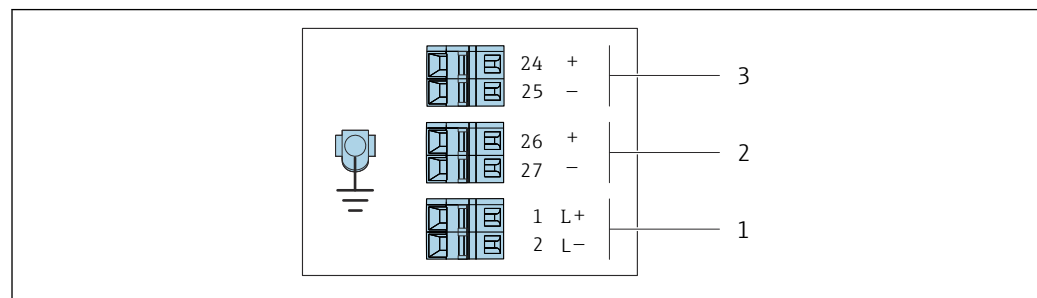

A0016888

2 Terminal assignment 4-20 mA HART with pulse/frequency/switch output

- 1 Power supply: DC 24 V
- 2 Output 1: 4-20 mA HART (active)
- 3 Output 2: pulse/frequency/switch output (passive)



Order code "Output"	Terminal number					
	Power supply		Output 1		Output 2	
	2 (L-)	1 (L+)	27 (-)	26 (+)	25 (-)	24 (+)
Option B	DC 24 V		4-20 mA HART (active)		Pulse/frequency/switch output (passive)	
Order code for "Output": Option B: 4-20 mA HART with pulse/frequency/switch output						

PROFIBUS DP connection version

 For use in the non-hazardous area and Zone 2/Div. 2

Order code for "Output", option **L**

Depending on the housing version, the transmitters can be ordered with terminals or device plugs.

Order code "Housing"	Connection methods available		Possible options for order code "Electrical connection"
	Output	Power supply	
Options A, B	Terminals	Terminals	<ul style="list-style-type: none"> ▪ Option A: coupling M20x1 ▪ Option B: thread M20x1 ▪ Option C: thread G ½" ▪ Option D: thread NPT ½"
Options A, B	Device plug connectors →  31	Terminals	<ul style="list-style-type: none"> ▪ Option L: plug M12x1 + thread NPT ½" ▪ Option N: plug M12x1 + coupling M20 ▪ Option P: plug M12x1 + thread G ½" ▪ Option U: plug M12x1 + thread M20
Options A, B, C	Device plug connectors →  31	Device plug connectors →  31	Option Q : 2 x plug M12x1
Order code for "Housing": <ul style="list-style-type: none"> ▪ Option A: compact, coated aluminum ▪ Option B: compact, hygienic, stainless ▪ Option C: ultra-compact, hygienic, stainless 			

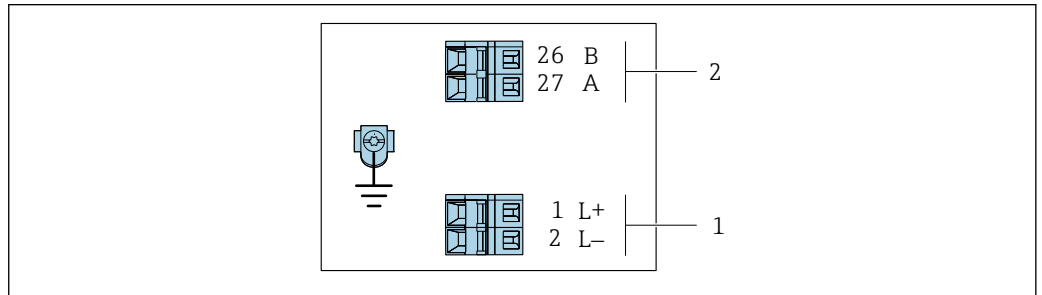

A0022716

 3 PROFIBUS DP terminal assignment

- 1 Power supply: DC 24 V
- 2 PROFIBUS DP



Order code "Output"	Terminal number			
	Power supply		Output	
	2 (L-)	1 (L+)	26 (RxD/TxD-P)	27 (RxD/TxD-N)
Option L	DC 24 V		B	A
Order code for "Output": Option L : PROFIBUS DP, for use in non-hazardous areas and Zone 2/Div. 2				

Modbus RS485 connection version

 For use in the non-hazardous area and Zone 2/Div. 2

Order code for "Output", option **M**

Depending on the housing version, the transmitters can be ordered with terminals or device plugs.

Order code "Housing"	Connection methods available		Possible options for order code "Electrical connection"
	Output	Power supply	
Options A, B	Terminals	Terminals	<ul style="list-style-type: none"> ▪ Option A: coupling M20x1 ▪ Option B: thread M20x1 ▪ Option C: thread G ½" ▪ Option D: thread NPT ½"
Options A, B	Device plugs →  31	Terminals	<ul style="list-style-type: none"> ▪ Option L: plug M12x1 + thread NPT ½" ▪ Option N: plug M12x1 + coupling M20 ▪ Option P: plug M12x1 + thread G ½" ▪ Option U: plug M12x1 + thread M20
Options A, B, C	Device plugs →  31	Device plugs →  31	Option Q: 2 x plug M12x1
Order code for "Housing": <ul style="list-style-type: none"> ▪ Option A: compact, coated aluminum ▪ Option B: compact, hygienic, stainless ▪ Option C: ultra-compact, hygienic, stainless 			

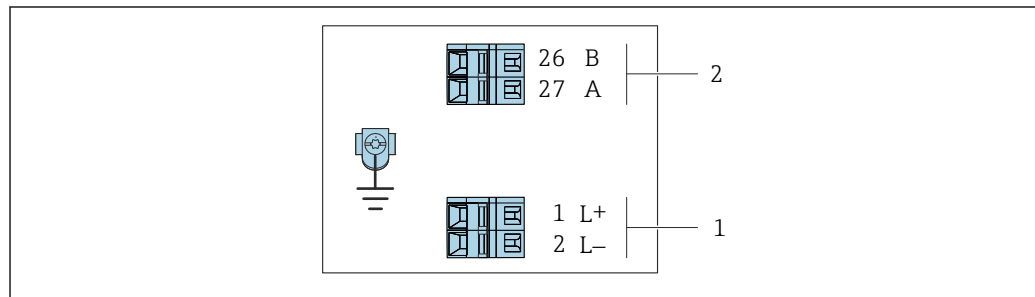

A0019528

 4 *Modbus RS485 terminal assignment, connection version for use in non-hazardous areas and Zone 2/Div. 2*

- 1 Power supply: DC 24 V
- 2 Modbus RS485

Order code "Output"	Terminal number			
	Power supply		Output	
	1 (L+)	2 (L-)	26 (B)	27 (A)
Option M	DC 24 V		Modbus RS485	
Order code for "Output": Option M : Modbus RS485, for use in non-hazardous areas and Zone 2/Div. 2				

Modbus RS485 connection version

 For use in the intrinsically safe area. Connection via Safety Barrier Promass 100.

Order code for "Output", option **M**

Depending on the housing version, the transmitters can be ordered with terminals or device plugs.

Order code "Housing"	Connection methods available		Possible options for order code "Electrical connection"
	Output	Power supply	
Options A, B	Terminals	Terminals	<ul style="list-style-type: none"> ▪ Option A: coupling M20x1 ▪ Option B: thread M20x1 ▪ Option C: thread G ½" ▪ Option D: thread NPT ½"
A, B, C	Device plugs →  31		Option I: plug M12x1
Order code for "Housing": <ul style="list-style-type: none"> ▪ Option A: compact, coated aluminum ▪ Option B: compact, hygienic, stainless ▪ Option C: ultra-compact, hygienic, stainless 			

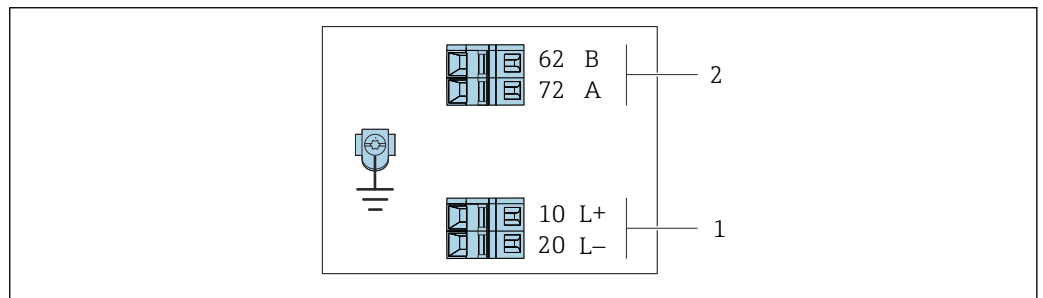

A0030219

 5 *Modbus RS485 terminal assignment, connection version for use in intrinsically safe areas (connection via Safety Barrier Promass 100)*

- 1 *Intrinsically safe power supply*
- 2 *Modbus RS485*

Order code "Output"	10 (L+)	20 (L-)	62 (B)	72 (A)
Option M	Intrinsically safe supply voltage		Modbus RS485 intrinsically safe	
Order code for "Output": Option M : Modbus RS485, for use in the intrinsically safe area (connection via Safety Barrier Promass 100)				

EtherNet/IP connection version

Order code for "Output", option **N**

Depending on the housing version, the transmitters can be ordered with terminals or device plugs.

Order code "Housing"	Connection methods available		Possible options for order code "Electrical connection"
	Output	Power supply	
Options A, B	Device plug connectors → 32	Terminals	<ul style="list-style-type: none"> ▪ Option L: plug M12x1 + thread NPT ½" ▪ Option N: plug M12x1 + coupling M20 ▪ Option P: plug M12x1 + thread G ½" ▪ Option U: plug M12x1 + thread M20
Options A, B, C	Device plug connectors → 32	Device plug connectors → 32	Option Q : 2 x plug M12x1

Order code for "Housing":

- Option **A**: compact, coated aluminum
- Option **B**: compact, hygienic, stainless
- Option **C** ultra-compact, hygienic, stainless

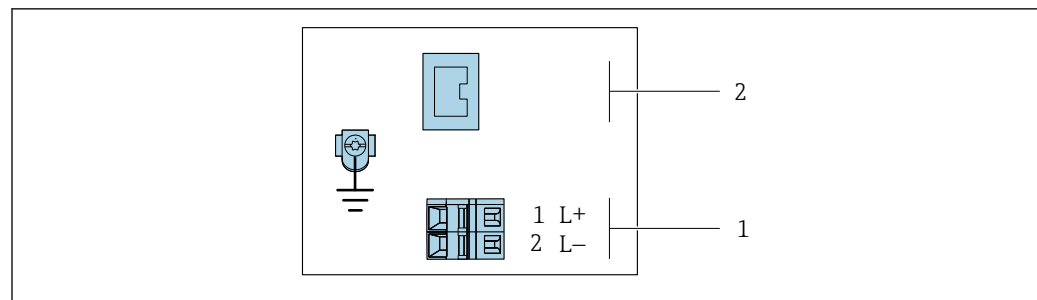

A0017054

6 EtherNet/IP terminal assignment

- 1 Power supply: DC 24 V
- 2 EtherNet/IP



Order code "Output"	Terminal number		Output Device plug M12x1
	Power supply 2 (L-)	1 (L+)	
Option N	DC 24 V		EtherNet/IP

Order code for "Output":
Option **N**: EtherNet/IP

PROFINET connection version

Order code for "Output", option **R**

Depending on the housing version, the transmitters can be ordered with terminals or device plugs.

Order code "Housing"	Connection methods available		Possible options for order code "Electrical connection"
	Output	Power supply	
Options A, B	Device plug connectors →  30	Terminals	<ul style="list-style-type: none"> ▪ Option L: plug M12x1 + thread NPT 1/2" ▪ Option N: plug M12x1 + coupling M20 ▪ Option P: plug M12x1 + thread G 1/2" ▪ Option U: plug M12x1 + thread M20
Options A, B, C	Device plug connectors →  30	Device plug connectors →  30	Option Q : 2 x plug M12x1
Order code for "Housing": <ul style="list-style-type: none"> ▪ Option A: compact, coated aluminum ▪ Option B: compact, hygienic, stainless ▪ Option C ultra-compact, hygienic, stainless 			

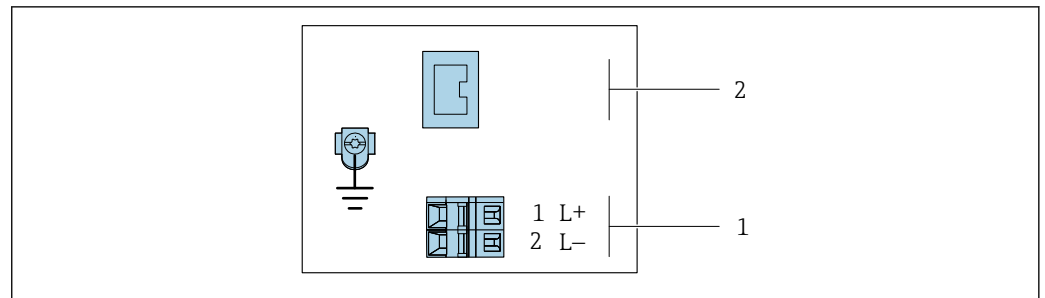

A0017054

 7 *PROFINET terminal assignment*

- 1 Power supply: DC 24 V
- 2 PROFINET

Order code "Output"	Terminal number		Output Device plug M12x1
	Power supply 2 (L-)	1 (L+)	
Option R	DC 24 V		PROFINET
Order code for "Output": Option R : PROFINET			

Safety Barrier Promass 100

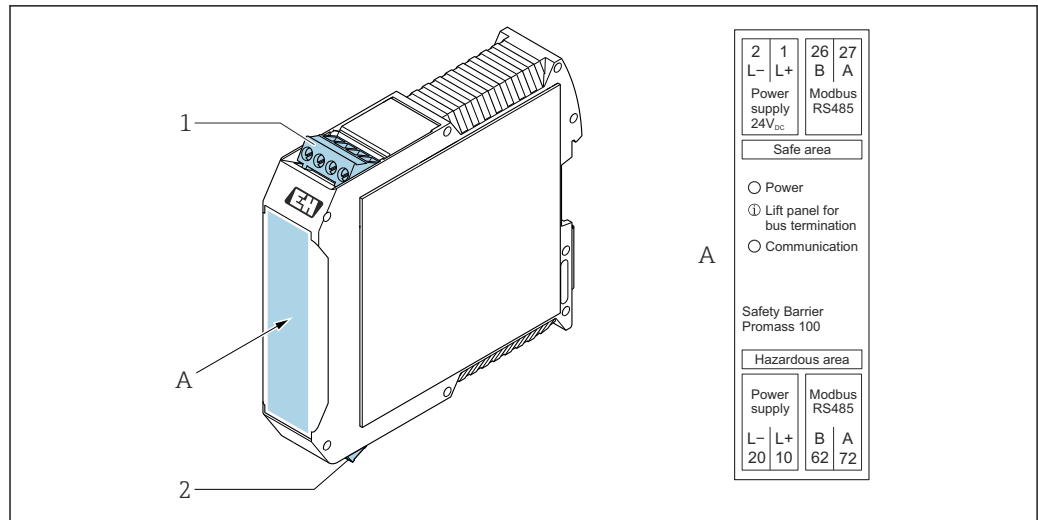

8 Safety Barrier Promass 100 with terminals

- 1 Non-hazardous area, Zone 2, Class I Division 2
- 2 Intrinsically safe area

Pin assignment, device plug

- i** Order codes for the M12x1 connectors, see the "Order code for **electrical connection**" column:
 - 4-20 mA HART, pulse/frequency/switch output → 23
 - PROFIBUS DP → 25
 - Modbus RS485 → 26
 - EtherNet/IP → 28
 - PROFINET → 29

Supply voltage

For all connection versions except MODBUS RS485 intrinsically safe (device side), male connection (plug)

- i** Device plug MODBUS RS485 intrinsically safe with supply voltage → 31

<p style="text-align: center;">A0029042</p>	Pin		Assignment	
	1	L+	DC 24 V	
	2		Not assigned	
	3		Not assigned	
	4	L-	DC 24 V	
	5		Grounding/shielding ¹⁾	
Coding		Plug/socket		
A		Plug		

1) Not assigned for order code for "Housing", option C "Ultra-compact, hygienic, stainless"

- i** The following is recommended as a socket:
 - Binder, series 763, part no. 79 3440 35 05
 - Alternatively: Phoenix part no. 1682951 SAC-5P-5.0-PUR/M12FS SH
 - With the order code for "Output", option **B**: 4-20 mA HART, pulse/frequency/switch output
 - With the order code for "Output", option **N**: EtherNet/IP
 - When using the device in a hazardous location: Use a suitably certified socket.

4-20 mA HART with pulse/frequency/switch output

Device plug for signal transmission (device side), female connection

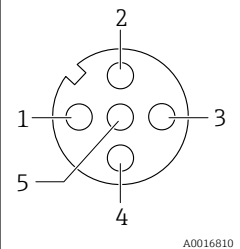
	Pin		Assignment
	1	+	4-20 mA HART (active)
	2	-	4-20 mA HART (active)
	3	+	Pulse/frequency/switch output (passive)
	4	-	Pulse/frequency/switch output (passive)
	5		Grounding/shielding ¹⁾
Coding		Plug/socket	
A		Socket	

1) Not assigned for order code for "Housing", option C "Ultra-compact, hygienic, stainless"



- Recommended plug: Binder, series 763, part no. 79 3439 12 05
- When using the device in a hazardous location, use a suitably certified plug.

PROFIBUS DP



For use in the non-hazardous area and Zone 2/Div. 2.

Device plug for signal transmission (device side)

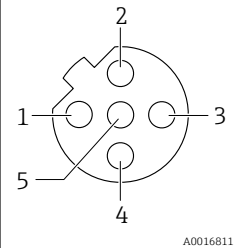
	Pin		Assignment
	1		Not assigned
	2	A	PROFIBUS DP
	3		Not assigned
	4	B	PROFIBUS DP
	5		Grounding/shielding ¹⁾
Coding		Plug/socket	
B		Socket	

1) Not assigned for order code for "Housing", option C "Ultra-compact, hygienic, stainless"



- Recommended plug: Binder, series 763, part no. 79 4449 20 05
- When using the device in a hazardous location, use a suitably certified plug.

MODBUS RS485

Device plug for signal transmission with supply voltage (device side), MODBUS RS485 (intrinsically safe)

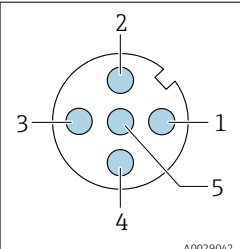
	Pin		Assignment
	1	L+	Supply voltage, intrinsically safe
	2	A	Modbus RS485 intrinsically safe
	3	B	
	4	L-	Supply voltage, intrinsically safe
	5		Grounding/shielding ¹⁾
Coding		Plug/socket	
A		Plug	

1) Not assigned for order code for "Housing", option C "Ultra-compact, hygienic, stainless"

- i** Recommended socket: Binder, series 763, part no. 79 3439 12 05
- When using the device in a hazardous location: Use a suitably certified socket.

Device plug for signal transmission (device side), MODBUS RS485 (not intrinsically safe)

- i** For use in the non-hazardous area and Zone 2/Div. 2.

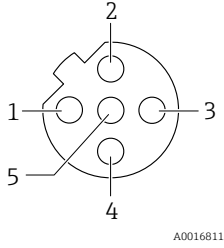
	Pin		Assignment
	1		Not assigned
	2	A	Modbus RS485
	3		Not assigned
	4	B	Modbus RS485
	5		Grounding/shielding ¹⁾
Coding		Plug/socket	
B		Socket	

1) Not assigned for order code for "Housing", option C "Ultra-compact, hygienic, stainless"

- i** Recommended plug: Binder, series 763, part no. 79 4449 20 05
- When using the device in a hazardous location, use a suitably certified plug.

EtherNet/IP

Device plug for signal transmission (device side)

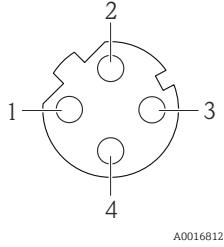
	Pin		Assignment
	1	+	Tx
	2	+	Rx
	3	-	Tx
	4	-	Rx
	Coding		Plug/socket
D		Socket	

- i** Recommended plug:
 - Binder, series 763, part no. 99 3729 810 04
 - Phoenix, part no. 1543223 SACC-M12MSD-4Q
 - When using the device in a hazardous location, use a suitably certified plug.

PROFINET

Device plug for signal transmission (device side)

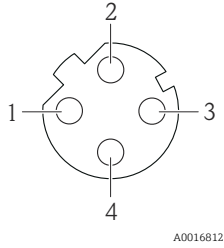
	Pin		Assignment
	1	+	TD +
	2	+	RD +
	3	-	TD -
	4	-	RD -
	Coding		Plug/socket
D		Socket	

- i** Recommended plug:
 - Binder, series 763, part no. 99 3729 810 04
 - Phoenix, part no. 1543223 SACC-M12MSD-4Q
 - When using the device in a hazardous location, use a suitably certified plug.

Supply voltage The power unit must be tested to ensure it meets safety requirements (e.g. PELV, SELV).

Transmitter

For device version with communication type:

- HART, PROFIBUS DP, EtherNet/IP: DC 20 to 30 V
- Modbus RS485, device version:
 - For use in the non-hazardous area and Zone 2/Div. 2: DC 20 to 30 V
 - For use in the intrinsically safe area: power supply via Safety Barrier Promass 100

Promass 100 safety barrier

DC 20 to 30 V

Power consumption

Transmitter

Order code for "Output"	Maximum Power consumption
Option B : 4-20 mA HART with pulse/frequency/switch output	3.5 W
Option L : PROFIBUS DP	3.5 W
Option M Modbus RS485, for use in non-hazardous areas and Zone 2/Div. 2	3.5 W
Option M : Modbus RS485, for use in intrinsically safe areas	2.45 W
Option N : EtherNet/IP	3.5 W
Option R : PROFINET	3.5 W

Promass 100 safety barrier

Order code for "Output"	Maximum Power consumption
Option M : Modbus RS485, for use in intrinsically safe areas	4.8 W

Current consumption

Transmitter

Order code for "Output"	Maximum Current consumption	Maximum switch-on current
Option B : 4-20mA HART, pul./freq./switch output	145 mA	18 A (< 0.125 ms)
Option L : PROFIBUS DP	145 mA	18 A (< 0.125 ms)
Option M Modbus RS485, for use in non-hazardous areas and Zone 2/Div. 2	90 mA	10 A (< 0.8 ms)
Option M : Modbus RS485, for use in intrinsically safe areas	145 mA	16 A (< 0.4 ms)
Option N : EtherNet/IP	145 mA	18 A (< 0.125 ms)
Option R : PROFINET	145 mA	18 A (< 0.125 ms)

Promass 100 safety barrier

Order code for "Output"	Maximum Current consumption	Maximum switch-on current
Option M : Modbus RS485, for use in intrinsically safe areas	230 mA	10 A (< 0.8 ms)

Device fuse

Fine-wire fuse (slow-blow) T2A

Power supply failure

- Totalizers stop at the last value measured.
- Depending on the device version, the configuration is retained in the device memory or in the plug-in memory (HistoROM DAT).
- Error messages (incl. total operated hours) are stored.

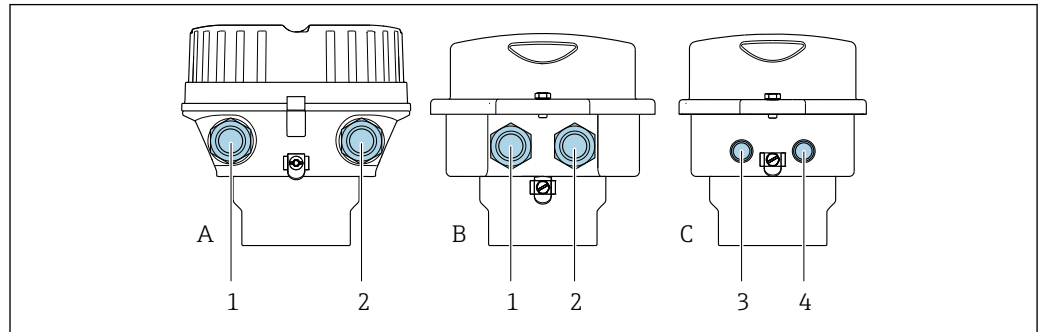
Electrical connection**Connecting the transmitter**

A0016924

- A Housing version: compact, coated, aluminum
 B Housing version: compact, hygienic, stainless
 1 Cable entry or device plug for signal transmission
 2 Cable entry or device plug for supply voltage
 C Housing version: ultra-compact, hygienic, stainless, M12 device plug
 3 Device plug for signal transmission
 4 Device plug for supply voltage

- i** ▪ Terminal assignment → 23
- Pin assignment, device plug → 30

- i** In the case of device versions with a connector, the transmitter housing does not need to be opened to connect the signal cable or power supply cable.

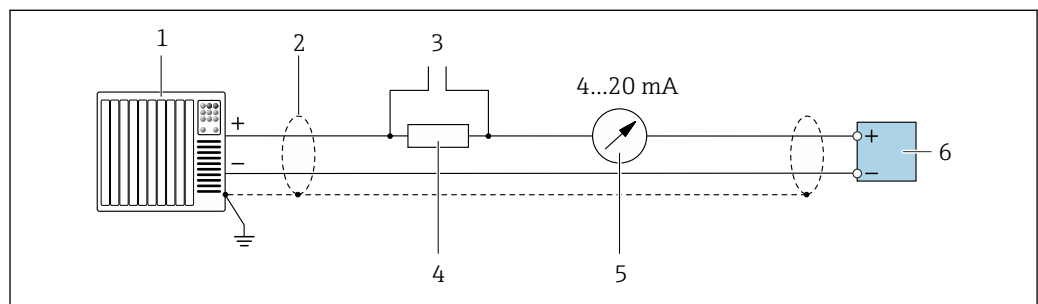
Connection examples*Current output 4 to 20 mA HART*

A0029055

9 Connection example for 4 to 20 mA HART current output (active)

- 1 Automation system with current input (e.g. PLC)
- 2 Cable shield provided at one end. The cable shield must be grounded at both ends to comply with EMC requirements; observe cable specifications → 39
- 3 Connection for HART operating devices → 87
- 4 Resistor for HART communication ($\geq 250 \Omega$): observe maximum load
- 5 Analog display unit: observe maximum load
- 6 Transmitter

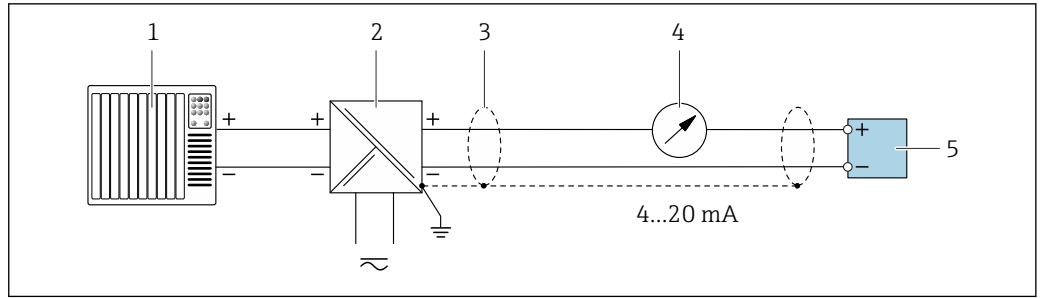

A0028762

10 Connection example for 4 to 20 mA HART current output (passive)

- 1 Automation system with current input (e.g. PLC)
- 2 Power supply
- 3 Cable shield provided at one end. The cable shield must be grounded at both ends to comply with EMC requirements; observe cable specifications → 39
- 4 Analog display unit: observe maximum load
- 5 Transmitter

Pulse/frequency output

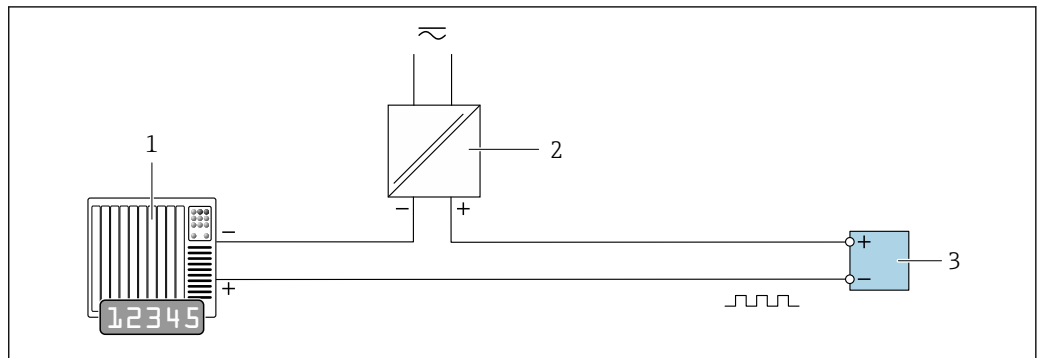

A0028761

11 Connection example for pulse/frequency output (passive)

- 1 Automation system with pulse/frequency input (e.g. PLC with 10 kΩ pull-up or pull-down resistor)
- 2 Power supply
- 3 Transmitter: observe input values → 9

Switch output

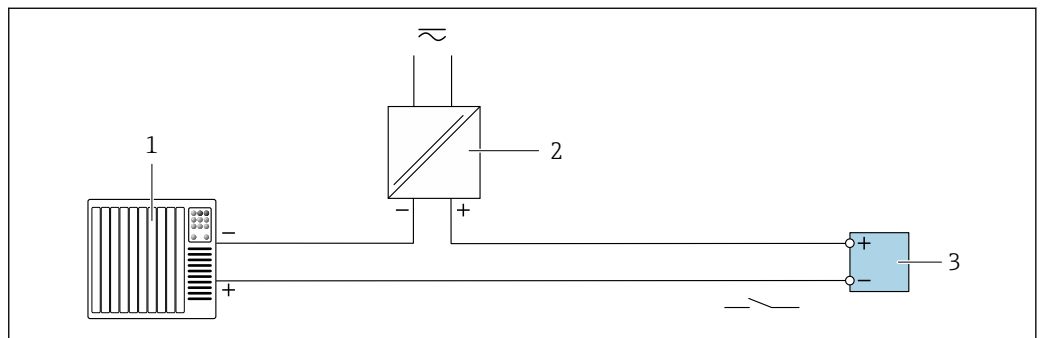

A0028760

12 Connection example for switch output (passive)

- 1 Automation system with switch input (e.g. PLC with a 10 kΩ pull-up or pull-down resistor)
- 2 Power supply
- 3 Transmitter: observe input values

PROFIBUS DP

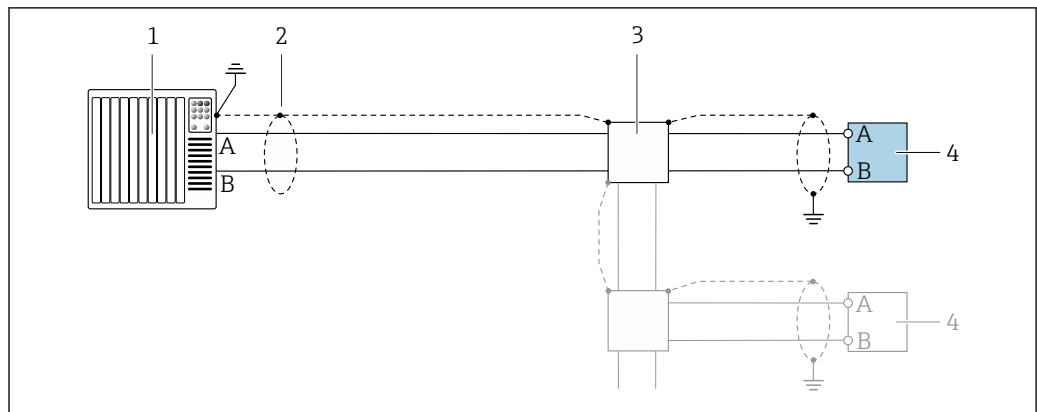

A0028765

13 Connection example for PROFIBUS DP, non-hazardous area and Zone 2/Div. 2

- 1 Control system (e.g. PLC)
- 2 Cable shield provided at one end. The cable shield must be grounded at both ends to comply with EMC requirements; observe cable specifications
- 3 Distribution box
- 4 Transmitter

i If baud rates > 1.5 MBaud an EMC cable entry must be used and the cable shield must continue as far as the terminal wherever possible.

Modbus RS485

Modbus RS485, non-hazardous area and Zone 2/Div. 2

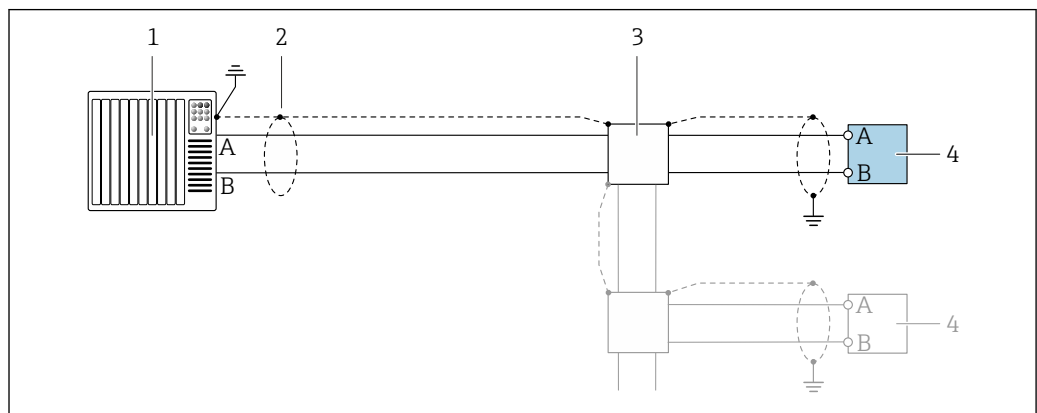

A0028765

14 Connection example for Modbus RS485, non-hazardous area and Zone 2/Div. 2

- 1 Control system (e.g. PLC)
- 2 Cable shield provided at one end. The cable shield must be grounded at both ends to comply with EMC requirements; observe cable specifications → 39
- 3 Distribution box
- 4 Transmitter

Modbus RS485 intrinsically safe

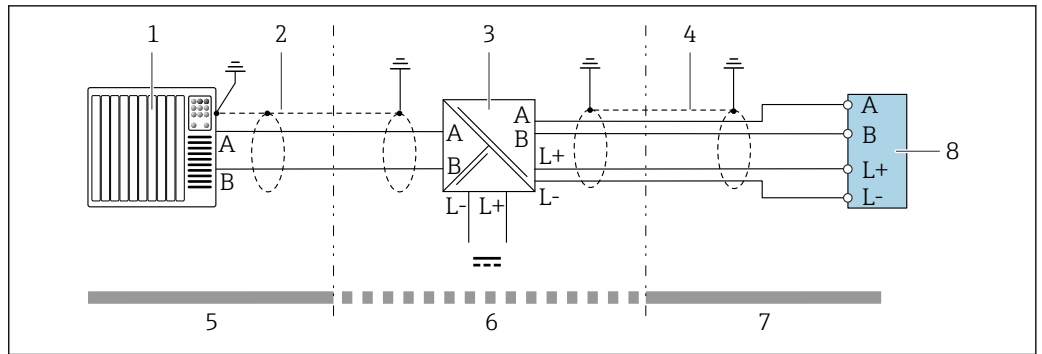

15 Connection example for Modbus RS485 intrinsically safe

- 1 Control system (e.g. PLC)
- 2 Cable shield provided at one end. Observe cable specifications
- 3 Safety Barrier Promass 100
- 4 Observe cable specifications
- 5 Non-hazardous area
- 6 Non-hazardous area and Zone 2/Div. 2
- 7 Intrinsically safe area
- 8 Transmitter

EtherNet/IP

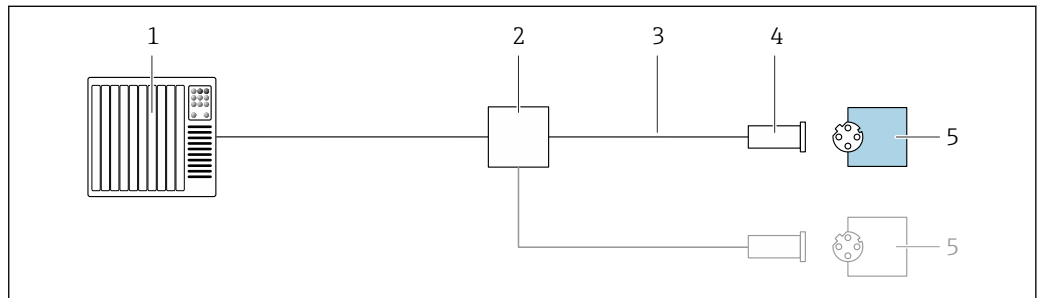

16 Connection example for Ethernet/IP

- 1 Control system (e.g. PLC)
- 2 Ethernet switch
- 3 Observe cable specifications
- 4 Device plug
- 5 Transmitter

PROFINET

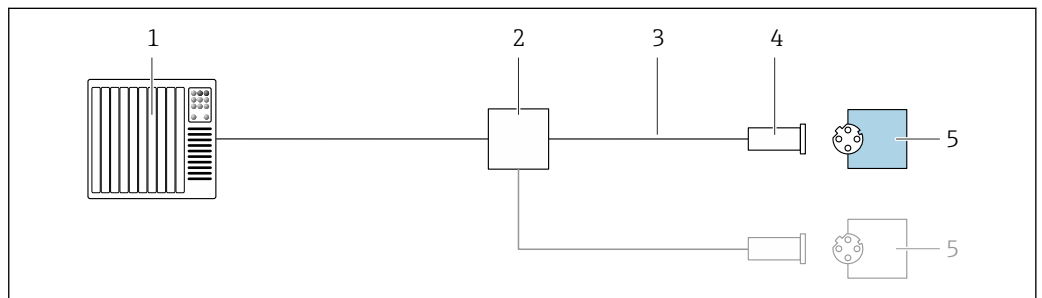

17 Connection example for PROFINET

- 1 Control system (e.g. PLC)
- 2 Ethernet switch
- 3 Observe cable specifications
- 4 Device plug
- 5 Transmitter

HART input

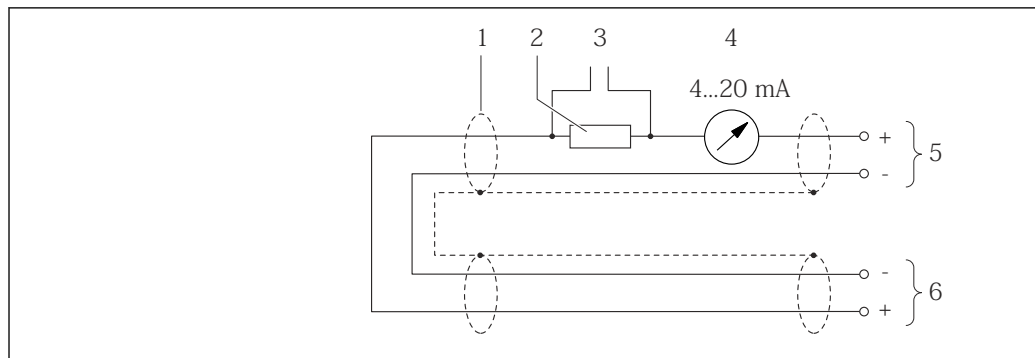

A0019828

18 Connection example for HART input (burst mode) via current output (active)

- 1 Cable shield provided at one end. Observe cable specifications
- 2 Resistor for HART communication ($\geq 250 \Omega$): observe maximum load
- 3 Connection for HART operating devices
- 4 Analog display unit
- 5 Transmitter
- 6 Sensor for external measured variable

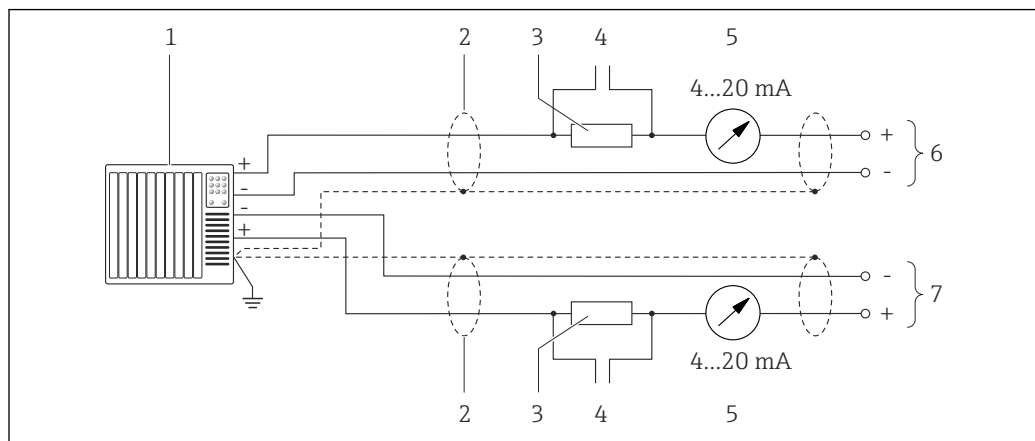

A0019830

19 Connection example for HART input (master mode) via current output (active)

- 1 Automation system with current input (e.g. PLC).
Prerequisite: automation system with HART version 6, HART commands 113 and 114 can be processed.
- 2 Cable shield provided at one end. Observe cable specifications
- 3 Resistor for HART communication ($\geq 250 \Omega$): observe maximum load
- 4 Connection for HART operating devices
- 5 Analog display unit
- 6 Transmitter
- 7 Sensor for external measured variable

Potential equalization

Requirements

For potential equalization:

- Pay attention to in-house grounding concepts
- Take account of operating conditions like the pipe material and grounding
- Connect the medium, sensor and transmitter to the same electrical potential
- Use a ground cable with a minimum cross-section of 6 mm^2 (0.0093 in^2) and a cable lug for potential equalization connections



For devices intended for use in hazardous locations, please observe the guidelines in the Ex documentation (XA).

Terminals

Transmitter

Spring terminals for wire cross-sections 0.5 to 2.5 mm^2 (20 to 14 AWG)

Promass 100 safety barrier

Plug-in screw terminals for wire cross-sections 0.5 to 2.5 mm^2 (20 to 14 AWG)

Cable entries

- Cable gland: M20 × 1.5 with cable Ø 6 to 12 mm (0.24 to 0.47 in)
- Thread for cable entry:
 - M20
 - G ½"
 - NPT ½"

Cable specification

Permitted temperature range

- The installation guidelines that apply in the country of installation must be observed.
- The cables must be suitable for the minimum and maximum temperatures to be expected.

Power supply cable (incl. conductor for the inner ground terminal)

Standard installation cable is sufficient.

Signal cable

Current output 4 to 20 mA HART

A shielded cable is recommended. Observe grounding concept of the plant.

Pulse /frequency /switch output

Standard installation cable is sufficient

PROFIBUS DP

The IEC 61158 standard specifies two types of cable (A and B) for the bus line which can be used for every transmission rate. Cable type A is recommended.

Cable type	A
Characteristic impedance	135 to 165 Ω at a measuring frequency of 3 to 20 MHz
Cable capacitance	< 30 pF/m
Wire cross-section	> 0.34 mm ² (22 AWG)
Cable type	Twisted pairs
Loop resistance	≤110 Ω/km
Signal damping	Max. 9 dB over the entire length of the cable cross-section
Shield	Copper braided shielding or braided shielding with foil shield. When grounding the cable shield, observe the grounding concept of the plant.



For further information on planning and installing PROFIBUS networks see:

Operating Instructions "PROFIBUS DP/PA: Guidelines for planning and commissioning" (BA00034S)

Modbus RS485

The EIA/TIA-485 standard specifies two types of cable (A and B) for the bus line which can be used for every transmission rate. Cable type A is recommended.

Cable type	A
Characteristic impedance	135 to 165 Ω at a measuring frequency of 3 to 20 MHz
Cable capacitance	< 30 pF/m
Wire cross-section	> 0.34 mm ² (22 AWG)
Cable type	Twisted pairs
Loop resistance	≤110 Ω/km
Signal damping	Max. 9 dB over the entire length of the cable cross-section
Shield	Copper braided shielding or braided shielding with foil shield. When grounding the cable shield, observe the grounding concept of the plant.

EtherNet/IP

The standard ANSI/TIA/EIA-568-B.2 Annex specifies CAT 5 as the minimum category for a cable used for EtherNet/IP. CAT 5e and CAT 6 are recommended.



For more information on planning and installing EtherNet/IP networks, please refer to the "Media Planning and Installation Manual. EtherNet/IP" of ODVA Organization

PROFINET

Standard IEC 61156-6 specifies CAT 5 as the minimum category for a cable used for PROFINET. CAT 5e and CAT 6 are recommended.



For more information on planning and installing PROFINET networks, see: "PROFINET Cabling and Interconnection Technology", Guideline for PROFINET

Connecting cable between Safety Barrier Promass 100 and measuring device

Cable type	Shielded twisted-pair cable with 2x2 wires. When grounding the cable shield, observe the grounding concept of the plant.
Maximum cable resistance	2.5 Ω , one side



Comply with the maximum cable resistance specifications to ensure the operational reliability of the measuring device.

The maximum cable length for individual wire cross-sections is specified in the table below. Observe the maximum capacitance and inductance per unit length of the cable and connection values for hazardous areas .

Wire cross-section		Maximum cable length	
[mm ²]	[AWG]	[m]	[ft]
0.5	20	70	230
0.75	18	100	328
1.0	17	100	328
1.5	16	200	656
2.5	14	300	984

Performance characteristics

Reference operating conditions

- Error limits based on ISO 11631
- Water with +15 to +45 °C (+59 to +113 °F) at 2 to 6 bar (29 to 87 psi)
- Specifications as per calibration protocol
- Accuracy based on accredited calibration rigs that are traced to ISO 17025.



To obtain measured errors, use the *Applicator* sizing tool → 96

Maximum measured error

o.r. = of reading; 1 g/cm³ = 1 kg/l; T = medium temperature

Base accuracy



Design fundamentals → 43

Mass flow and volume flow (liquids)

±0.10 % o.r.

Density (liquids)

Under reference conditions	Standard density calibration ¹⁾	Wide-range Density specification ^{2) 3)}
[g/cm ³]	[g/cm ³]	[g/cm ³]
±0.0005	±0.01	±0.002

- 1) Valid over the entire temperature and density range
- 2) Valid range for special density calibration: 0 to 2 g/cm³, +10 to +80 °C (+50 to +176 °F)
- 3) order code for "Application package", option EE "Special density"

Temperature

$$\pm 0.5 \text{ °C} \pm 0.005 \cdot T \text{ °C} (\pm 0.9 \text{ °F} \pm 0.003 \cdot (T - 32) \text{ °F})$$

Zero point stability

DN		Zero point stability	
[mm]	[in]	[kg/h]	[lb/min]
8	$\frac{3}{8}$	0.20	0.007
15	$\frac{1}{2}$	0.65	0.024
25	1	1.80	0.066
40	$1\frac{1}{2}$	4.50	0.165
50	2	7.0	0.257

Flow values

Flow values as turndown parameters depending on the nominal diameter.

SI units

DN [mm]	1:1	1:10	1:20	1:50	1:100	1:500
	[kg/h]	[kg/h]	[kg/h]	[kg/h]	[kg/h]	[kg/h]
8	2 000	200	100	40	20	4
15	6 500	650	325	130	65	13
25	18 000	1 800	900	360	180	36
40	45 000	4 500	2 250	900	450	90
50	70 000	7 000	3 500	1 400	700	140

US units

DN [inch]	1:1	1:10	1:20	1:50	1:100	1:500
	[lb/min]	[lb/min]	[lb/min]	[lb/min]	[lb/min]	[lb/min]
$\frac{3}{8}$	73.50	7.350	3.675	1.470	0.735	0.147
$\frac{1}{2}$	238.9	23.89	11.95	4.778	2.389	0.478
1	661.5	66.15	33.08	13.23	6.615	1.323
$1\frac{1}{2}$	1 654	165.4	82.70	33.08	16.54	3.308
2	2 573	257.3	128.7	51.46	25.73	5.146

Accuracy of outputs

 The output accuracy must be factored into the measured error if analog outputs are used, but can be ignored for fieldbus outputs (e.g. Modbus RS485, EtherNet/IP).

The outputs have the following base accuracy specifications.

Current output

Accuracy	Max. $\pm 5 \mu\text{A}$
-----------------	--------------------------

Pulse/frequency output



o.r. = of reading

Accuracy	Max. $\pm 50 \text{ ppm o.r.}$ (over the entire ambient temperature range)
-----------------	--

Repeatability

o.r. = of reading; $1 \text{ g/cm}^3 = 1 \text{ kg/l}$; T = medium temperature

Base repeatability

 Design fundamentals →  43

Mass flow and volume flow (liquids)

$\pm 0.05 \%$ o.r.

Density (liquids)

$\pm 0.00025 \text{ g/cm}^3$

Temperature

$\pm 0.25 \text{ }^\circ\text{C} \pm 0.0025 \cdot T \text{ }^\circ\text{C}$ ($\pm 0.45 \text{ }^\circ\text{F} \pm 0.0015 \cdot (T-32) \text{ }^\circ\text{F}$)

Response time

The response time depends on the configuration (damping).

Influence of ambient temperature**Current output**

o.r. = of reading

Temperature coefficient	Max. $\pm 0.005 \%$ o.r./ $^\circ\text{C}$
--------------------------------	--

Pulse/frequency output

Temperature coefficient	No additional effect. Included in accuracy.
--------------------------------	---

Influence of medium temperature**Mass flow and volume flow**

o.f.s. = of full scale value

If there is a difference between the temperature during zero adjustment and the process temperature, the additional measured error of the sensors is typically $\pm 0.0002 \%$ o.f.s./ $^\circ\text{C}$ ($\pm 0.0001 \%$ o.f.s./ $^\circ\text{F}$).

The influence is reduced when the zero adjustment is performed at process temperature.

Density

If there is a difference between the density calibration temperature and the process temperature, the measured error of the sensors is typically $\pm 0.0001 \text{ g/cm}^3 \text{ }^\circ\text{C}$ ($\pm 0.00005 \text{ g/cm}^3 \text{ }^\circ\text{F}$). Field density adjustment is possible.

Wide-range density specification (special density calibration)

If the process temperature is outside the valid range (\rightarrow  40) the measured error is $\pm 0.0001 \text{ g/cm}^3 \text{ }^\circ\text{C}$ ($\pm 0.00005 \text{ g/cm}^3 \text{ }^\circ\text{F}$)

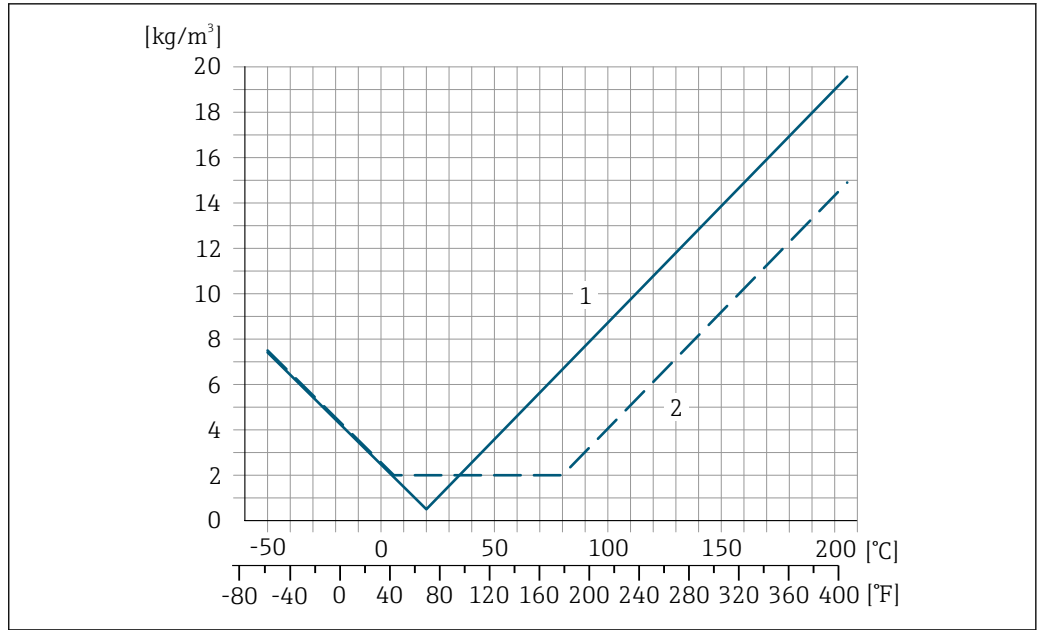

- 1 Field density adjustment, for example at +20 °C (+68 °F)
- 2 Special density calibration

Temperature

$\pm 0.005 \cdot T \text{ } ^\circ\text{C}$ ($\pm 0.005 \cdot (T - 32) \text{ } ^\circ\text{F}$)

Influence of medium pressure

The tables below show the effect that a difference in pressure between the calibration pressure and the process pressure has on the accuracy in the case of the mass flow and density.

o.r. = of reading



It is possible to compensate for the effect by:

- Reading in the current pressure measured value via the current input or a digital input.
- Specifying a fixed value for the pressure in the device parameters.



Operating Instructions .

DN		[% o.r./bar]	[% o.r./psi]
[mm]	[in]		
8	3/8	-0.002	-0.0001
15	1/2	-0.006	-0.0004
25	1	-0.005	-0.0003
40	1 1/2	-0.007	-0.0005
50	2	-0.006	-0.0004

Design fundamentals

o.r. = of reading, o.f.s. = of full scale value

BaseAccu = base accuracy in % o.r., BaseRepeat = base repeatability in % o.r.

MeasValue = measured value; ZeroPoint = zero point stability

Calculation of the maximum measured error as a function of the flow rate

Flow rate	Maximum measured error in % o.r.
$\geq \frac{\text{ZeroPoint}}{\text{BaseAccu}} \cdot 100$ <small>A0021332</small>	$\pm \text{BaseAccu}$ <small>A0021339</small>
$< \frac{\text{ZeroPoint}}{\text{BaseAccu}} \cdot 100$ <small>A0021333</small>	$\pm \frac{\text{ZeroPoint}}{\text{MeasValue}} \cdot 100$ <small>A0021334</small>

Calculation of the maximum repeatability as a function of the flow rate

Flow rate	Maximum repeatability in % o.r.
$\geq \frac{1/2 \cdot \text{ZeroPoint}}{\text{BaseRepeat}} \cdot 100$ <small>A0021335</small>	$\pm \text{BaseRepeat}$ <small>A0021340</small>
$< \frac{1/2 \cdot \text{ZeroPoint}}{\text{BaseRepeat}} \cdot 100$ <small>A0021336</small>	$\pm \frac{1}{2} \cdot \frac{\text{ZeroPoint}}{\text{MeasValue}} \cdot 100$ <small>A0021337</small>

Example of maximum measured error

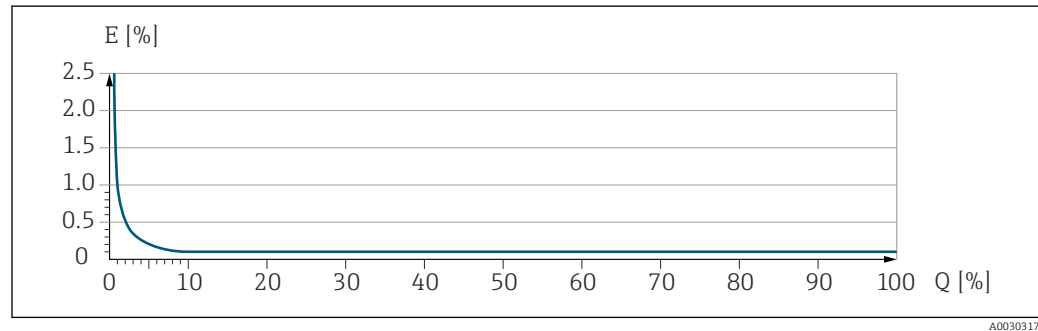

E Maximum measured error in % o.r. (example)

Q Flow rate in % of maximum full scale value

Mounting

Mounting location

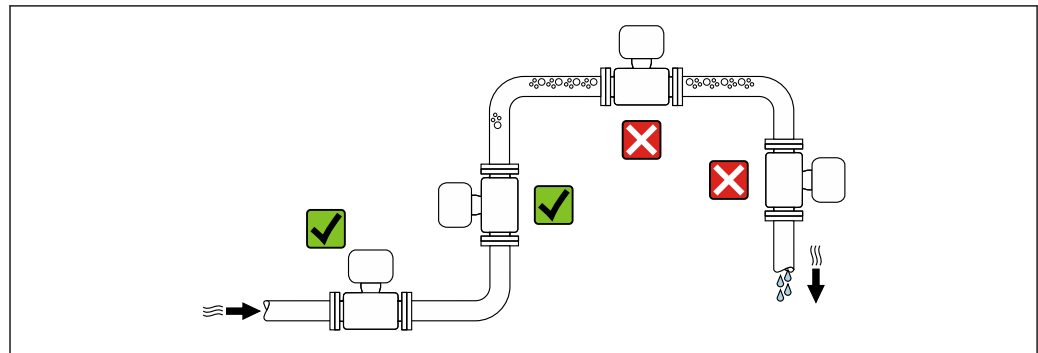

To prevent measuring errors arising from accumulation of gas bubbles in the measuring pipe, avoid the following mounting locations in the piping:

- Highest point of a pipeline.
- Directly upstream of a free pipe outlet in a down pipe.

Installation in down pipes

However, the following installation suggestion allows for installation in an open vertical pipeline. Pipe restrictions or the use of an orifice with a smaller cross-section than the nominal diameter prevent the sensor running empty while measurement is in progress.

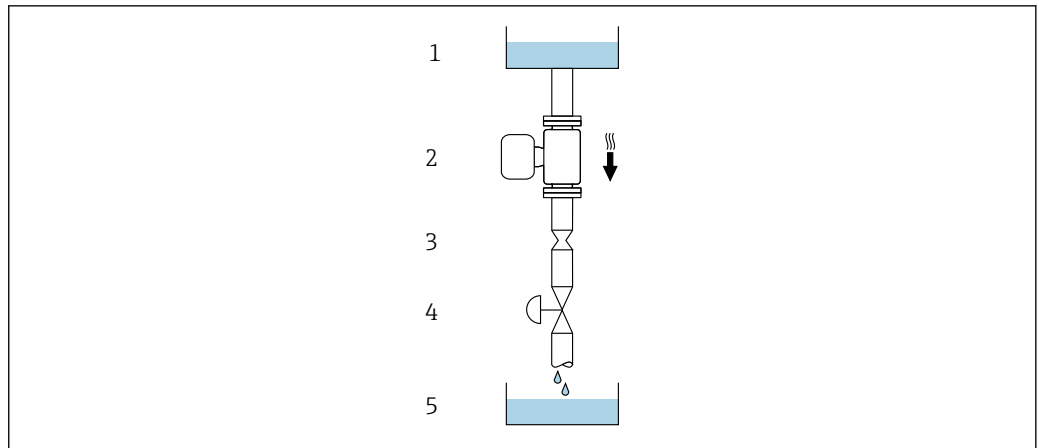

A0028773

☑ 20 Installation in a down pipe (e.g. for batching applications)

- 1 Supply tank
- 2 Sensor
- 3 Orifice plate, pipe restriction
- 4 Valve
- 5 Batching tank

DN		Ø orifice plate, pipe restriction	
[mm]	[in]	[mm]	[in]
8	3/8	6	0.24
15	1/2	10	0.40
25	1	14	0.55
40	1 1/2	22	0.87
50	2	28	1.10

Orientation

The direction of the arrow on the sensor nameplate helps you to install the sensor according to the flow direction (direction of medium flow through the piping).

Orientation		Recommendation
A	Vertical orientation	 A0015591
B	Horizontal orientation, transmitter at top	 A0015589
C	Horizontal orientation, transmitter at bottom	 A0015590
D	Horizontal orientation, transmitter at side	 A0015592

- 1) This orientation is recommended to ensure self-draining.
- 2) Applications with low process temperatures may reduce the ambient temperature. To maintain the minimum ambient temperature for the transmitter, this orientation is recommended.
- 3) Applications with high process temperatures may increase the ambient temperature. To maintain the maximum ambient temperature for the transmitter, this orientation is recommended.

If a sensor is installed horizontally with a curved measuring tube, match the position of the sensor to the fluid properties.

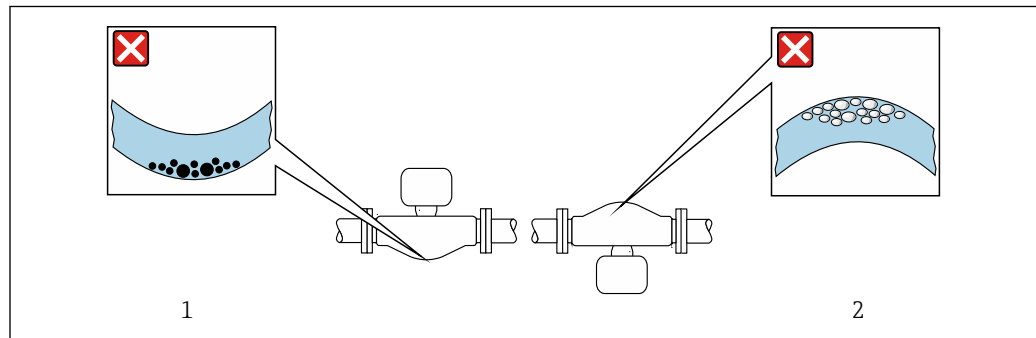

A0028774

21 Orientation of sensor with curved measuring tube

- 1 Avoid this orientation for fluids with entrained solids: Risk of solids accumulating.
- 2 Avoid this orientation for outgassing fluids: Risk of gas accumulating.

Inlet and outlet runs

No special precautions need to be taken for fittings that create turbulence, such as valves, elbows or T-pieces, as long as no cavitation occurs → 53.

Special mounting instructions

Drainability

When installed vertically, the measuring tube can be drained completely and protected against buildup.

When the sensor is installed in a horizontal line, eccentric clamps can be used to ensure complete drainability. When the system is pitched in a specific direction and at a specific slope, gravity can be used to achieve complete drainability. The sensor must be mounted in the correct position to ensure full drainability in the horizontal position. Markings on the sensor show the correct mounting position to optimize drainability.

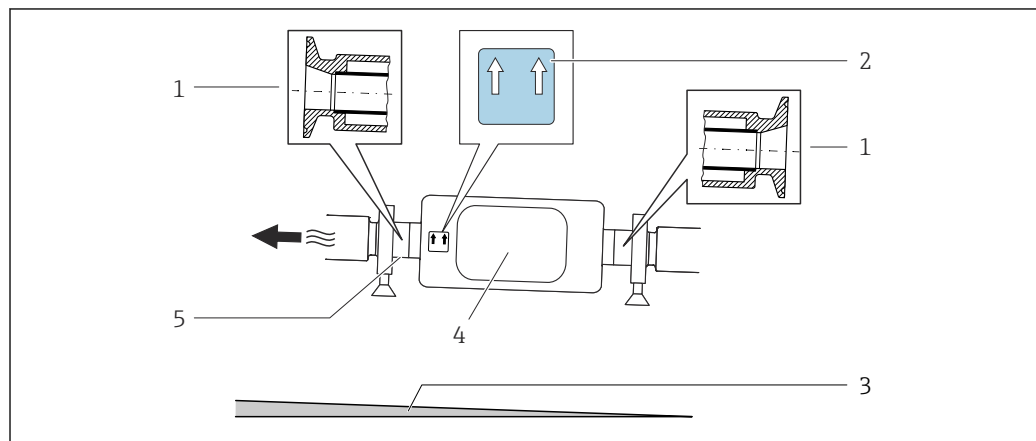

A0016583

- 1 Eccentric clamp connection
- 2 "This side up" label indicates which side is up
- 3 For DN 8 to 25 (3/8 to 1"): Gradient: approx. 2% or 21 mm/m (0.24 in/ft); for DN 40 to 50 (1½ to 2"): Gradient approx. 2° or 35 mm/m (0.42 in/ft)
- 4 Transmitter
- 5 Line on the underside indicates the lowest point of the eccentric process connection.

Hygienic compatibility

When installing in hygienic applications, please refer to the information in the "Certificates and approvals/hygienic compatibility" section

Securing with mounting clamp in the case of hygiene connections

It is not necessary to provide additional support for the sensor for operational performance purposes. If, however, additional support is required for installation purposes, the following dimensions must be observed.

Use mounting clamp with lining between clamp and measuring instrument.

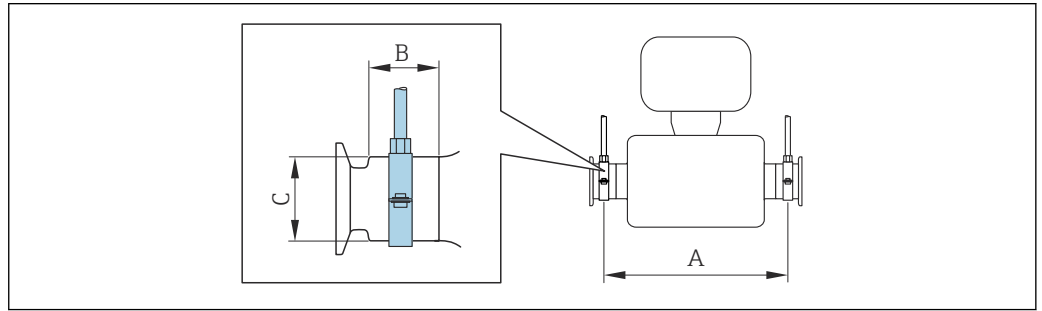

A0030298

DN		A		B		C	
[mm]	[in]	[mm]	[in]	[mm]	[in]	[mm]	[in]
8	3/8	298	11.73	33	1.3	28	1.1
15	1/2	402	15.83	33	1.3	28	1.1
25	1	542	21.34	33	1.3	38	1.5
40	1 1/2	658	25.91	36.5	1.44	56	2.2
50	2	772	30.39	44.1	1.74	75	2.95

Installing the Safety Barrier Promass 100

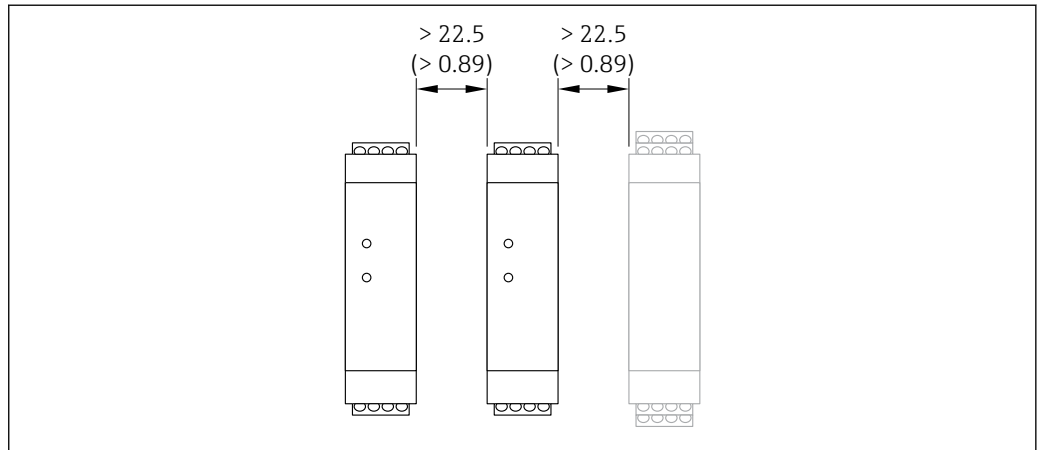

A0016894

22 Minimum distance between additional Safety Barrier Promass 100 or other modules. Engineering unit mm (in)

Environment

Ambient temperature range

Measuring device	<ul style="list-style-type: none"> ■ -40 to +60 °C (-40 to +140 °F) ■ Order code for "Test, certificate", option JM: -50 to +60 °C (-58 to +140 °F)
Safety Barrier Promass 100	-40 to +60 °C (-40 to +140 °F)

- ▶ If operating outdoors:
Avoid direct sunlight, particularly in warm climatic regions.

Storage temperature

-40 to +80 °C (-40 to +176 °F), preferably at +20 °C (+68 °F) (standard version)
-50 to +80 °C (-58 to +176 °F) (Order code for "Test, certificate", option JM)

Climate class DIN EN 60068-2-38 (test Z/AD)

Degree of protection

Transmitter and sensor

- Standard: IP66/67, Type 4X enclosure, suitable for pollution degree 4
- With the order code for "Sensor options", option CM: IP69 can also be ordered
- When the housing is open: IP20, Type 1 enclosure, suitable for pollution degree 2
- Display module: IP20, Type 1 enclosure, suitable for pollution degree 2

Safety Barrier Promass 100

IP20

Vibration- and shock-resistance

Vibration sinusoidal, in accordance with IEC 60068-2-6

- 2 to 8.4 Hz, 3.5 mm peak
- 8.4 to 2 000 Hz, 1 g peak

Vibration broad-band random, according to IEC 60068-2-64

- 10 to 200 Hz, 0.003 g²/Hz
- 200 to 2 000 Hz, 0.001 g²/Hz
- Total: 1.54 g rms

Shock half-sine, according to IEC 60068-2-27

6 ms 30 g

Rough handling shocks, according to IEC 60068-2-31

Interior cleaning

- Cleaning in place (CIP)
- Sterilization in place (SIP)
- Cleaning with pigs

Options

Oil- and grease-free version for wetted parts, without declaration
Order code for "Service", option HA

Electromagnetic compatibility (EMC)

- Depends on the communication protocol:
 - HART, PROFIBUS DP, EtherNet/IP:
As per IEC/EN 61326 and NAMUR Recommendation 21 (NE 21)
 - Modbus RS485:
As per IEC/EN 61326 and NAMUR Recommendation 21 (NE 21)
 - PROFINET: as per IEC/EN 61326
- Complies with emission limits for industry as per EN 55011 (Class A)
- Device version with PROFIBUS DP: Complies with emission limits for industry as per EN 50170 Volume 2, IEC 61784



The following applies for PROFIBUS DP: If baud rates > 1.5 MBaud, an EMC cable entry must be used and the cable shield must continue as far as the terminal wherever possible.



Details are provided in the Declaration of Conformity.



This unit is not intended for use in residential environments and cannot guarantee adequate protection of the radio reception in such environments.

Process

Medium temperature range

Standard version	-50 to +150 °C (-58 to +302 °F)	Order code for "Measuring tube mat., wetted surface", option BB, BC, BD
Extended temperature version	-50 to +205 °C (-58 to +401 °F)	Order code for "Measuring tube mat., wetted surface", option TD, TG

Dependency of ambient temperature on medium temperature

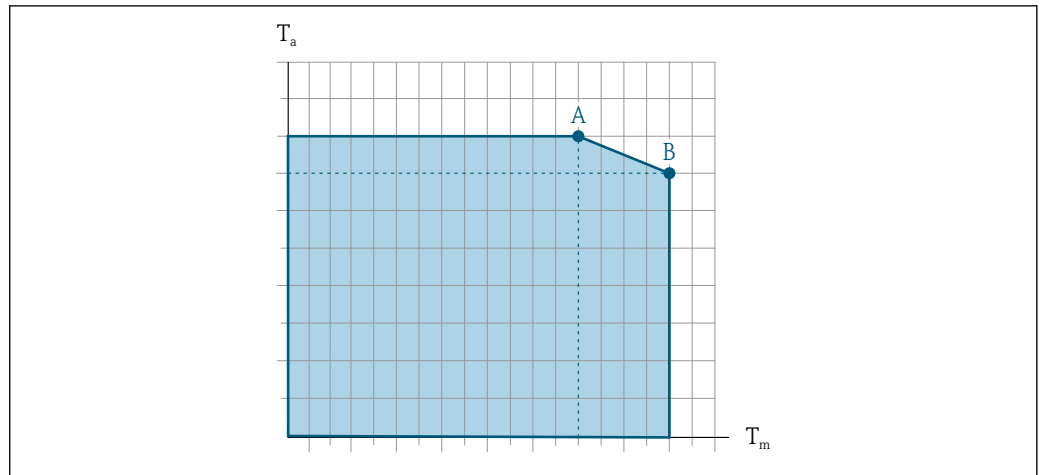

A0031121

23 Exemplary representation, values in the table below.

T_a Ambient temperature

T_m Medium temperature

A Maximum permitted medium temperature T_m at $T_{a\max} = 60\text{ °C}$ (140 °F); higher medium temperatures T_m require a reduction in the ambient temperature T_a

B Maximum permitted ambient temperature T_a for the maximum specified medium temperature T_m of the sensor



Values for devices that are used in the hazardous area:
Separate Ex documentation (XA) for the device .

Density

0 to 5 000 kg/m³ (0 to 312 lb/cf)

Pressure-temperature ratings

The following pressure/temperature diagrams apply to all pressure-bearing parts of the device and not just the process connection. The diagrams show the maximum permissible medium pressure depending on the specific medium temperature.



Pressure-temperature ratings with the +151 to +205 °C (+304 to +401 °F) temperature range only for the extended temperature version of the measuring device.

Flange according to EN 1092-1 (DIN 2501)

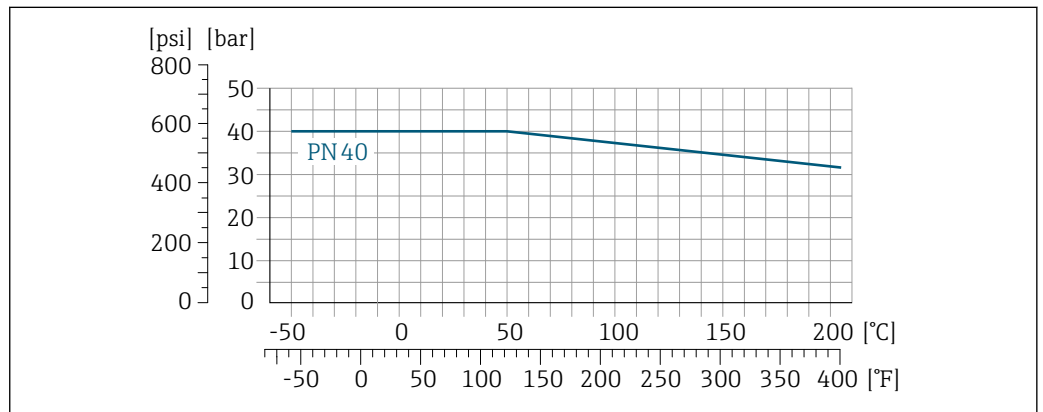

A0029905-EN

24 With flange material 1.4404 (F316/F316L).

Flange according to ASME B16.5

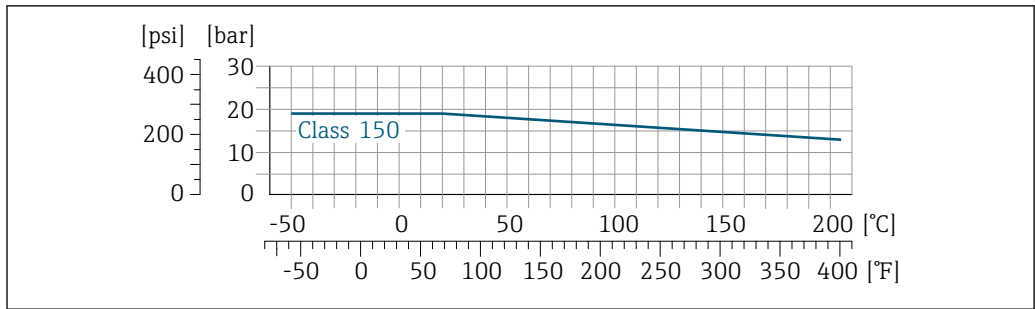

A0029906-EN

25 With flange material 1.4404 (F316/F316L)

Flange JIS B2220

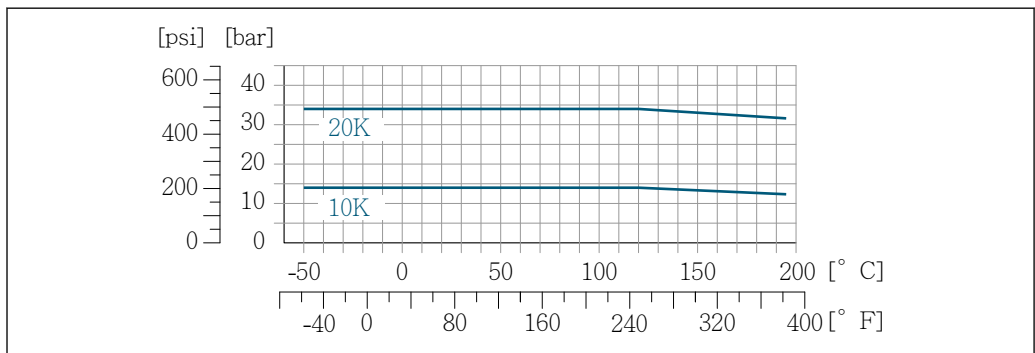

A0029907-EN

26 With flange material 1.4404 (F316/F316L)

Flange DIN 11864-2 Form A

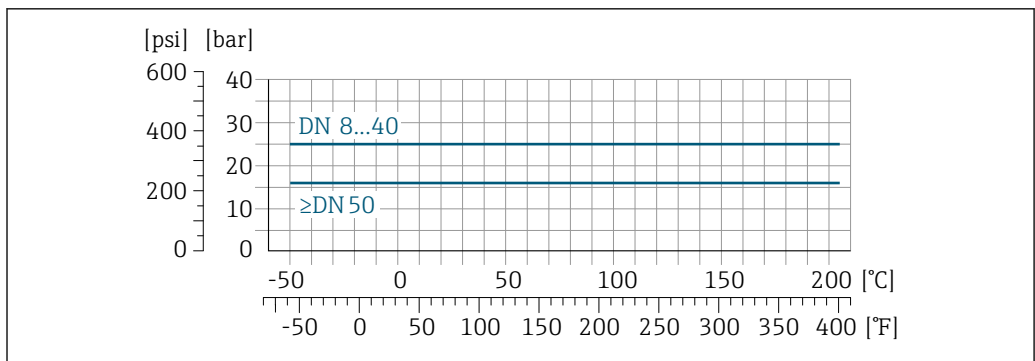

A0029908-EN

27 With flange material 1.4435 (316L)

Neumo BioConnect, BBS flange

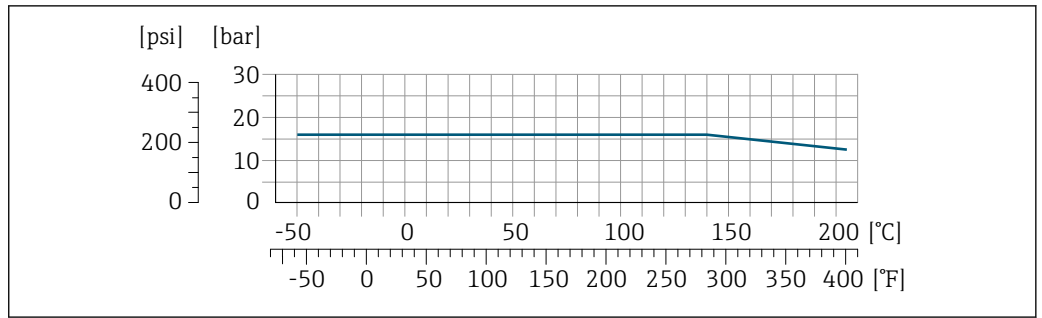

A0027782-EN

28 With flange material 1.4435 (316L)

Thread DIN 11851

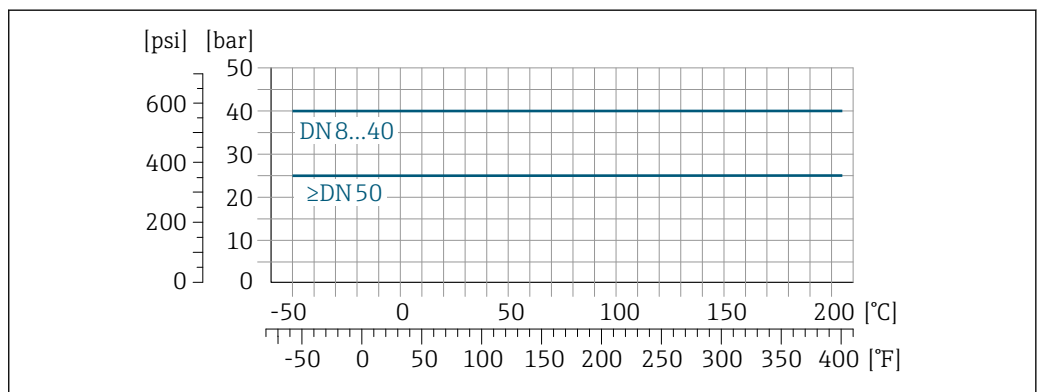

A0029909-EN

29 With flange material 1.4435 (316L)

DIN 11851 allows for applications up to +140 °C (+284 °F) if suitable sealing materials are used. Please take this into account when selecting seals and counterparts, as these components can limit the pressure and temperature range.

Thread DIN 11864-1 Form A

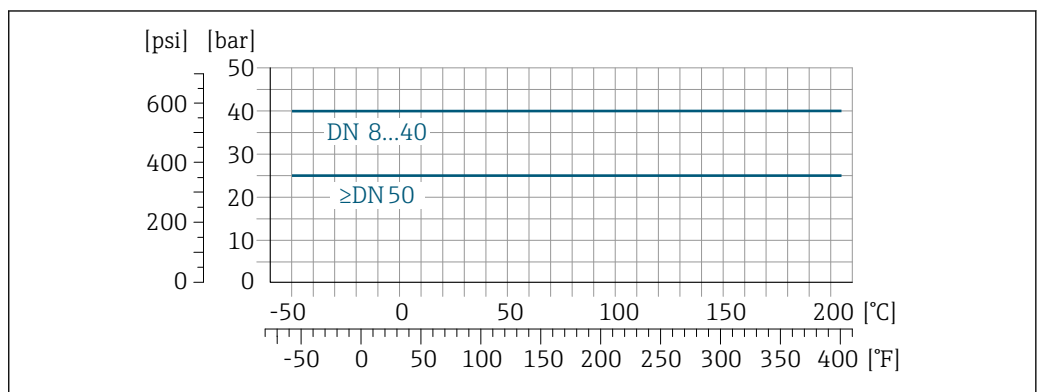

A0029910-EN

30 With connection material 1.4435 (316L)

Thread ISO 2853

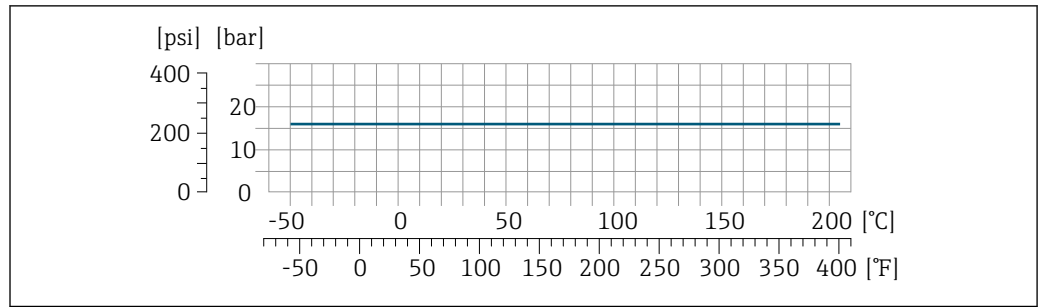

A0034703-EN

31 With connection material 1.4435 (316L)

Thread SMS 1145

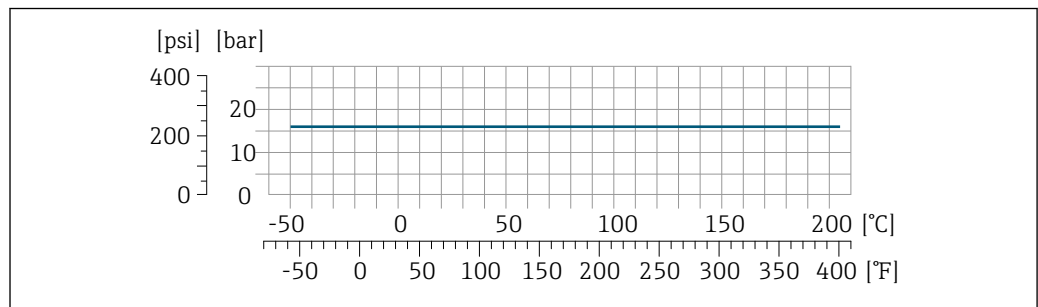

A0029889-EN

32 With connection material 1.4435 (316L)

SMS 1145 allows for applications up to 6 bar (87 psi) if suitable sealing materials are used. Please take this into account when selecting seals and counterparts, as these components can limit the pressure and temperature range.

Clamp connections DIN 11864-3 Form A

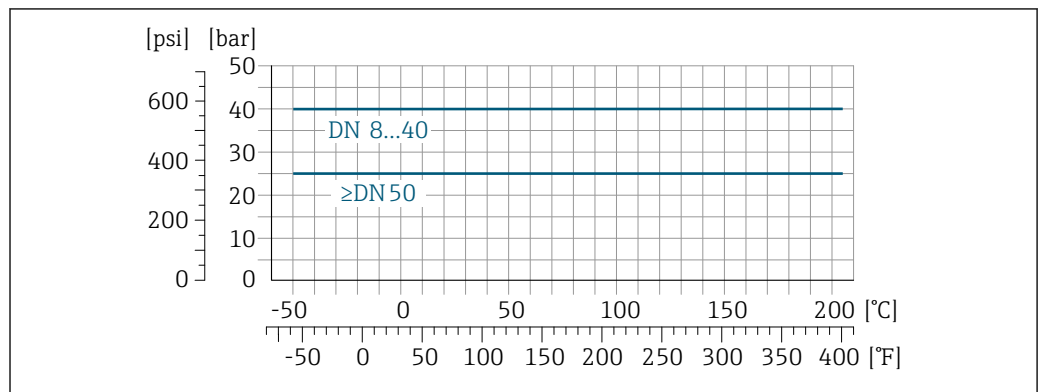

A0029910-EN

33 With connection material 1.4435 (316L)

Tri-Clamp; clamp connection ISO 2852, DIN 32676, BBS, Neumo BioConnect

The clamp connections are suitable up to a maximum pressure of 16 bar (232 psi). Please observe the operating limits of the clamp and seal used as they can be over 16 bar (232 psi). The clamp and seal are not included in the scope of supply.

Sensor housing

The sensor housing is filled with dry nitrogen gas and protects the electronics and mechanics inside.

i If a measuring tube fails (e.g. due to process characteristics like corrosive or abrasive fluids), the fluid will initially be contained by the sensor housing.

If the sensor is to be purged with gas (gas detection), it should be equipped with purge connections.

i Do not open the purge connections unless the containment can be filled immediately with a dry, inert gas. Use only low pressure to purge.

Maximum pressure: 5 bar (72.5 psi)

Burst pressure of the sensor housing

The following sensor housing burst pressures are only valid for standard devices and/or devices equipped with closed purge connections (not opened/as delivered).

If a device fitted with purge connections (order code for "Sensor option", option CH "Purge connection") is connected to the purge system, the maximum pressure is determined by the purge system itself or by the device, depending on which component has the lower pressure classification.

The sensor housing burst pressure refers to a typical internal pressure which is reached prior to mechanical failure of the sensor housing and which was determined during type testing. The corresponding type test declaration can be ordered with the device (order code for "Additional approval", option LN "Sensor housing burst pressure, type test").

DN		Sensor housing burst pressure	
[mm]	[in]	[bar]	[psi]
8	3/8	190	2 755
15	1/2	175	2 538
25	1	165	2 392
40	1 1/2	152	2 204
50	2	103	1 494

For information on the dimensions: see the "Mechanical construction" section

Flow limit

Select the nominal diameter by optimizing between the required flow range and permissible pressure loss.

i For an overview of the full scale values for the measuring range, see the "Measuring range" section → 8

- The minimum recommended full scale value is approx. 1/20 of the maximum full scale value
- In most applications, 20 to 50 % of the maximum full scale value can be considered ideal
- A low full scale value must be selected for abrasive media (such as liquids with entrained solids): flow velocity < 1 m/s (< 3 ft/s).

i To calculate the flow limit, use the *Applicator* sizing tool → 96

Pressure loss

i To calculate the pressure loss, use the *Applicator* sizing tool → 96

System pressure

It is important that cavitation does not occur, or that gases entrained in the liquids do not outgas. This is prevented by means of a sufficiently high system pressure.

For this reason, the following mounting locations are recommended:

- At the lowest point in a vertical pipe
- Downstream from pumps (no danger of vacuum)

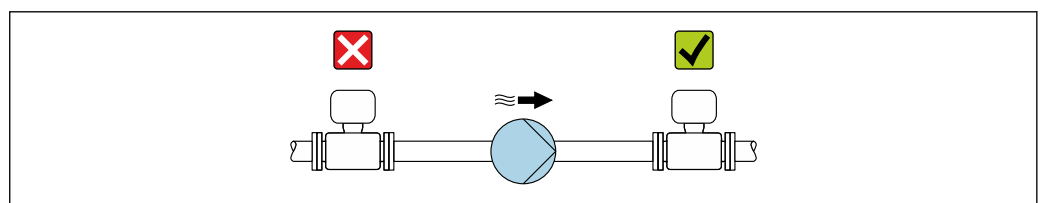

A0028777

Thermal insulation

In the case of some fluids, it is important to keep the heat radiated from the sensor to the transmitter to a low level. A wide range of materials can be used for the required insulation.

The following device versions are recommended for versions with thermal insulation:

- Version with extended neck for insulation:
Order code for "Sensor option", option CG with an extended neck length of 105 mm (4.13 in).
- Extended temperature version:
Order code for "Measuring tube material", option TD or TG with an extended neck length of 105 mm (4.13 in).

NOTICE

Electronics overheating on account of thermal insulation!

- ▶ Recommended orientation: horizontal orientation, transmitter housing pointing downwards.
- ▶ Do not insulate the transmitter housing .
- ▶ Maximum permissible temperature at the lower end of the transmitter housing: 80 °C (176 °F)
- ▶ Thermal insulation with not isolated extended neck: We recommend that you do not insulate the extended neck in order to ensure optimum dissipation of heat.

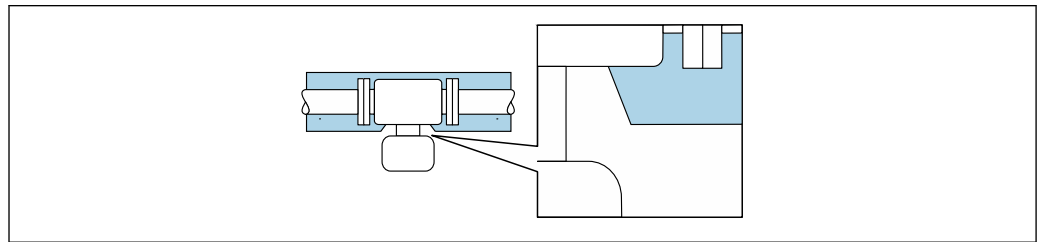

A0034391

34 Thermal insulation with not isolated extended neck

Heating

Some fluids require suitable measures to avoid loss of heat at the sensor.

Heating options

- Electrical heating, e.g. with electric band heaters ¹⁾
- Via pipes carrying hot water or steam
- Via heating jackets

 Heating jackets for the sensors can be ordered as accessories from Endress+Hauser →  94.

NOTICE

Danger of overheating when heating

- ▶ Ensure that the temperature at the lower end of the transmitter housing does not exceed 80 °C (176 °F).
- ▶ Ensure that sufficient convection takes place at the transmitter neck.
- ▶ Ensure that a sufficiently large area of the transmitter neck remains exposed. The uncovered part serves as a radiator and protects the electronics from overheating and excessive cooling.
- ▶ When using in potentially explosive atmospheres, observe the information in the device-specific Ex documentation. For detailed information on the temperature tables, see the separate document entitled "Safety Instructions" (XA) for the device.
- ▶ Take account of the behavior of process diagnostic "830 Ambient temperature too high" and "832 Electronics temperature too high" if it is not possible to avoid overheating with a suitable system layout.

Vibrations

The high oscillation frequency of the measuring tubes ensures that the correct operation of the measuring system is not influenced by plant vibrations.

1) The use of parallel electric band heaters is generally recommended (bidirectional electricity flow). Particular considerations must be made if a single-wire heating cable is to be used. Additional information is provided in the document EA01339D "Installation instructions for electrical trace heating systems" →  98

Mechanical construction

Dimensions in SI units

Compact version

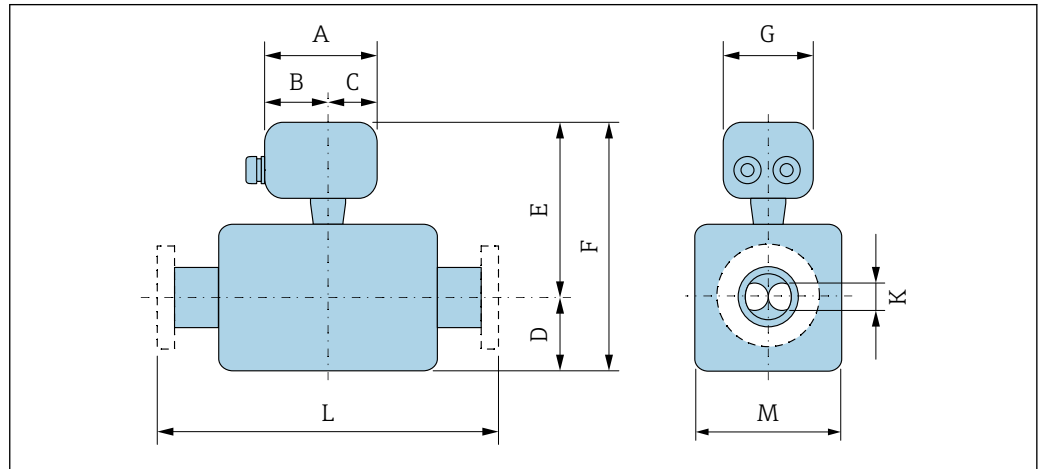

A0033787

Order code for "Housing", option A "Compact, aluminum, coated"

DN [mm]	A [mm]	B [mm]	C [mm]	D [mm]	E ^{1) 2)} [mm]	F ^{1) 2)} [mm]	G [mm]	K [mm]	L [mm]	M [mm]
8	147.5	93.5	54	108	191	299	136	92	³⁾	92
15	147.5	93.5	54	108	191	299	136	92	³⁾	92
25	147.5	93.5	54	121	191	312	136	92	³⁾	92
40	147.5	93.5	54	173	215	388	136	132	³⁾	132
50	147.5	93.5	54	241	226	467	136	167	³⁾	167

- 1) If using an extension neck for the extended temperature range, order code for "Sensor option", option CG and order code for "Measuring tube material", option TD, TG: values +70 mm
- 2) If using a display, order code for "Display; Operation", option B: values +28 mm
- 3) Depending on the process connection

Order code for "Housing", option B "Compact hygienic, stainless"

DN [mm]	A [mm]	B [mm]	C [mm]	D [mm]	E ^{1) 2)} [mm]	F ^{1) 2)} [mm]	G [mm]	K [mm]	L [mm]	M [mm]
8	136.8	78	58.8	108	186	294	133.5	8.31	³⁾	92
15	136.8	78	58.8	108	186	294	133.5	12.00	³⁾	92
25	136.8	78	58.8	121	186	307	133.5	17.60	³⁾	92
40	136.8	78	58.8	173	210	383	133.5	26.00	³⁾	132
50	136.8	78	58.8	241	221	462	133.5	40.50	³⁾	167

- 1) If using an extension neck for the extended temperature range, order code for "Sensor option", option CG and order code for "Measuring tube material", option TD, TG: values +70 mm
- 2) If using a display, order code for "Display; Operation", option B: values +14 mm
- 3) Depending on the process connection

Order code for "Housing", option C "Ultra-compact hygienic, stainless"

DN [mm]	A [mm]	B [mm]	C [mm]	D [mm]	E ^{1) 2)} [mm]	F ^{1) 2)} [mm]	G [mm]	K [mm]	L [mm]	M [mm]
8	123.6	67.7	55.9	108	186	294	111.4	8.31	³⁾	92
15	123.6	67.7	55.9	108	186	294	111.4	12.00	³⁾	92

DN [mm]	A [mm]	B [mm]	C [mm]	D [mm]	E ^{1) 2)} [mm]	F ^{1) 2)} [mm]	G [mm]	K [mm]	L [mm]	M [mm]
25	123.6	67.7	55.9	121	186	307	111.4	17.60	³⁾	92
40	123.6	67.7	55.9	173	210	383	111.4	26.00	³⁾	132
50	123.6	67.7	55.9	241	221	462	111.4	40.50	³⁾	167

- 1) If using an extension neck for the extended temperature range, order code for "Sensor option", option CG and order code for "Measuring tube material", option TD, TG: values +70 mm
- 2) If using a display, order code for "Display; Operation", option B: values +14 mm
- 3) Depending on the process connection

Flange connections

Fixed flange EN 1092-1, ASME B16.5, JIS B2220

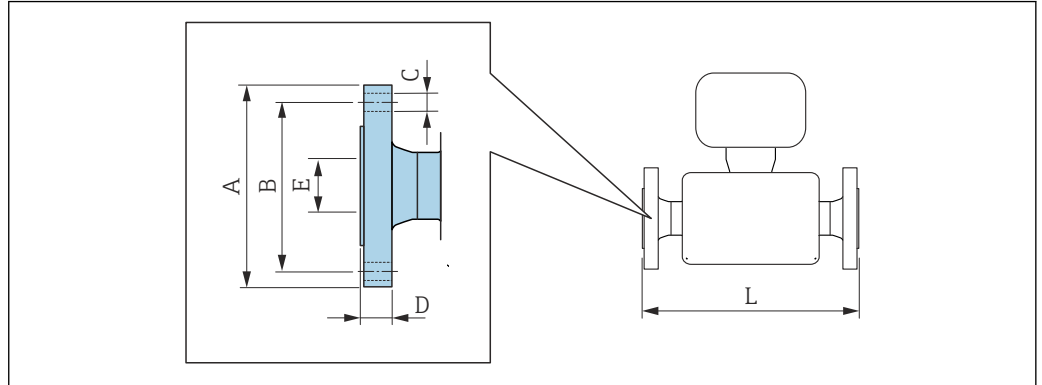

A0015621

i Length tolerance for dimension L in mm:
+1.5 / -2.0

Flange according to EN 1092-1 (DIN 2501): PN 40						
1.4404 (F316/F316L)						
<i>Order code for "Process connection", option D2W</i>						
DN [mm]	A [mm]	B [mm]	C [mm]	D [mm]	E [mm]	L [mm]
8 ¹⁾	95	65	4 × Ø14	17.0	17.3	336
15	95	65	4 × Ø14	20.0	17.3	440
25	115	85	4 × Ø14	19.0	28.5	580
40	150	110	4 × Ø18	21.0	43.1	707
50	165	125	4 × Ø18	25.0	54.5	828

Surface roughness (flange): EN 1092-1 Form B1 (DIN 2526 Form C), Ra 3.2 to 12.5 µm

1) DN 8 with DN 15 flanges as standard

Flange according to ASME B16.5: CI 150						
1.4404 (F316/F316L)						
<i>Order code for "Process connection", option AAW</i>						
DN [mm]	A [mm]	B [mm]	C [mm]	D [mm]	E [mm]	L [mm]
8 ¹⁾	90	60.3	4 × Ø15.7	11.2	15.7	336
15	90	60.3	4 × Ø15.7	11.2	15.7	440
25	110	79.4	4 × Ø15.7	14.2	26.7	580
40	125	98.4	4 × Ø15.7	17.5	40.9	707
50	150	120.7	8 × Ø19.1	19.1	52.6	828

Surface roughness (flange): Ra 3.2 to 6.3 µm

1) DN 8 with DN 15 flanges as standard

Flange JIS B2220: 20K 1.4404 (F316/F316L) <i>Order code for "Process connection", option NEW</i>						
DN [mm]	A [mm]	B [mm]	C [mm]	D [mm]	E [mm]	L [mm]
8 ¹⁾	95	70	4 × Ø15	16.0	15	336
15	95	70	4 × Ø15	16.0	15	440
25	125	90	4 × Ø19	17.5	25	580
40	140	105	4 × Ø19	20.0	40	707
50	155	120	8 × Ø19	27.5	50	828
Surface roughness (flange): Ra 3.2 to 6.3 µm						

- 1) DN 8 with DN 15 flanges as standard

Fixed flange DIN 11864-2

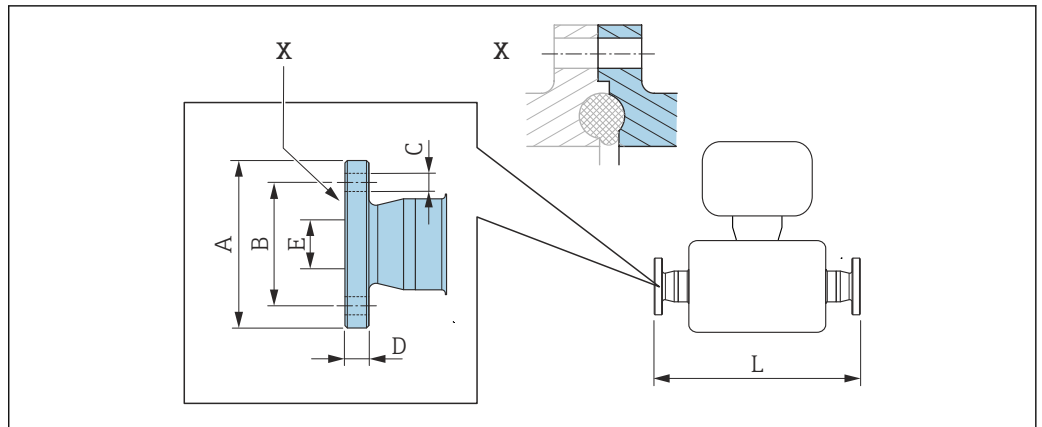

A0015627

35 Detail X: Asymmetrical process connection; the part shown in blue is provided by the supplier.

i Length tolerance for dimension L in mm:
+1.5 / -2.0

Flange DIN 11864-2 Form A, for pipe according to DIN 11866 series A, flange with notch 1.4435 (316L) Order code for "Process connection", option KJW						
DN [mm]	A [mm]	B [mm]	C [mm]	D [mm]	E [mm]	L [mm]
8	59.0	42	4 × Ø9	10	16.00	384
15	59.0	42	4 × Ø9	10	16.00	488
25	70.0	53	4 × Ø9	10	26.00	626
40	82.0	65	4 × Ø9	10	38.00	753
50	94.0	77	4 × Ø9	10	50.00	877

Ra_{max} 0.76 µm: order code for "Measuring tube material", option BB, TD
 Ra_{max} 0.38 µm electropolished: order code for "Measuring tube material", option BC, TG

BBS fixed flange

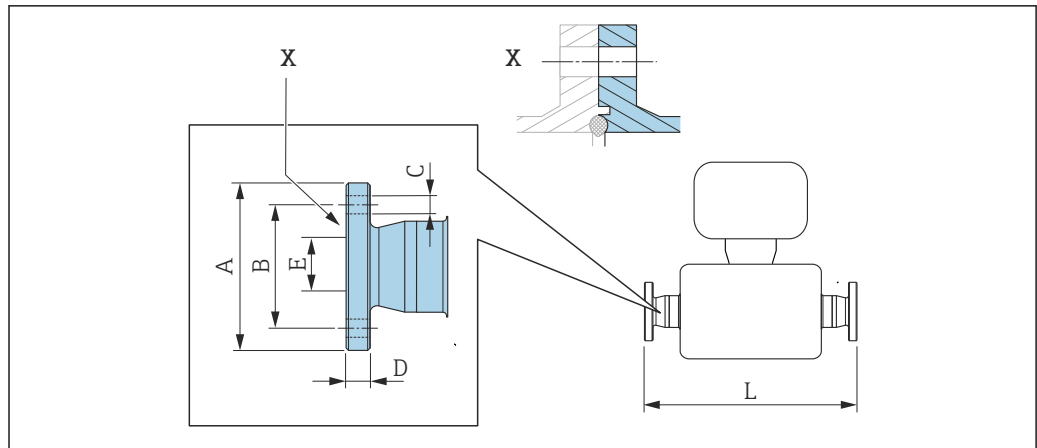

A0016910

36 Detail X: Asymmetrical process connection; the part shown in blue is provided by the supplier.

i Length tolerance for dimension L in mm:
+1.5 / -2.0

BBS flange small (sterile orbital), for pipe according to DIN 11866 series A, female 1.4435 (316L)						
Order code for "Process connection", option BSK						
DN [mm]	A [mm]	B [mm]	C [mm]	D [mm]	E [mm]	L [mm]
8	59	42	4 × Ø9	10	10.00	384
15	59	42	4 × Ø9	10	16.00	488
25	70	53	4 × Ø9	10	26.00	626
40	82	65	4 × Ø9	10	38.00	753
50	94	77	4 × Ø9	10	50.00	877

Ra_{max} 0.76 µm: order code for "Measuring tube material", option BB, TD
 Ra_{max} 0.38 µm electropolished: order code for "Measuring tube material", option BC, TG

BBS flange small (sterile orbital), for pipe according to DIN 11866 series B, female 1.4435 (316L)						
Order code for "Process connection", option BSL						
DN [mm]	A [mm]	B [mm]	C [mm]	D [mm]	E [mm]	L [mm]
8	59	42	4 × Ø9	10	14.00	384
15	62	45	4 × Ø9	10	18.10	488
25	74	57	4 × Ø9	10	29.70	626
40	88	71	4 × Ø9	10	44.30	753
50	103	85	4 × Ø9	10	56.30	877

Ra_{max} 0.76 µm: order code for "Measuring tube material", option BB, TD
 Ra_{max} 0.38 µm electropolished: order code for "Measuring tube material", option BC, TG

Neumo BioConnect fixed flange

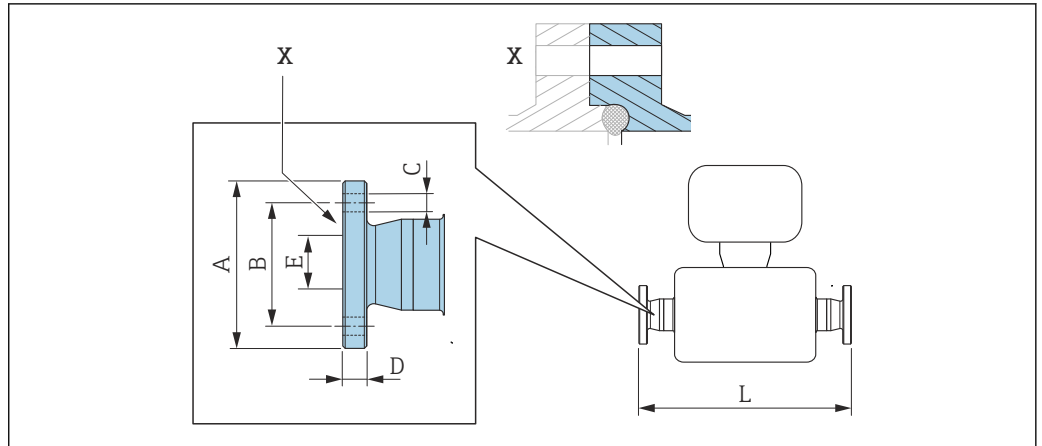

A0016907

37 Detail X: Asymmetrical process connection; the part shown in blue is provided by the supplier.

i Length tolerance for dimension L in mm:
+1.5 / -2.0

Neumo BioConnect flange (sterile orbital), for pipe according to DIN 11866 series A, flange form R 1.4435 (316L) Order code for "Process connection", option BSB						
DN [mm]	A [mm]	B [mm]	C [mm]	D [mm]	E [mm]	L [mm]
8	65	45	4 × Ø9	10	10.00	384
15	75	55	4 × Ø9	10	16.00	488
25	85	65	4 × Ø9	12	26.00	626
40	100	80	4 × Ø9	12	38.00	753
50	110	90	4 × Ø9	14	50.00	877

Ra_{max} 0.76 µm: order code for "Measuring tube material", option BB, TD
 Ra_{max} 0.38 µm electropolished: order code for "Measuring tube material", option BC, TG

Clamp connections

Tri-Clamp

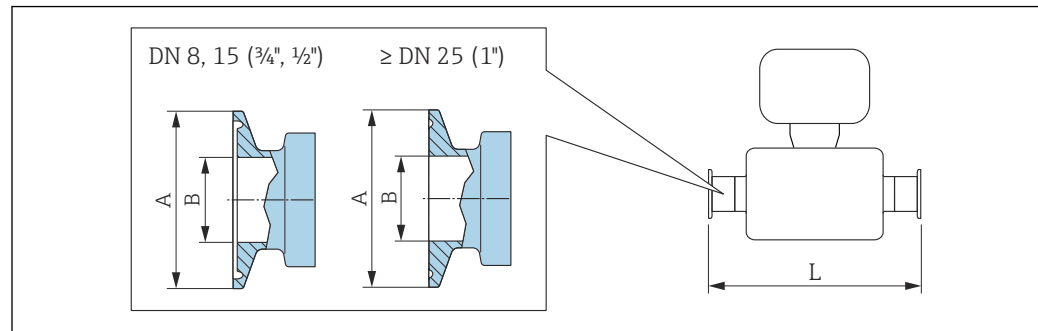

38 Engineering unit mm (in)

i Length tolerance for dimension L in mm:
+1.5 / -2.0

Tri-Clamp, for pipe according to DIN 11866 series C 1.4435 (316L) Order code for "Process connection", option FHW				
DN [mm]	Clamp [in]	A [mm]	B [mm]	L [mm]
8	½	25.0	9.40	362
15	¾	25.0	15.75	466
25	1 ¹⁾	50.4	22.10	606
40	1½ ¹⁾	50.4	34.80	731
50	2 ¹⁾	63.9	47.50	853

Ra_{max} 0.76 µm: order code for "Measuring tube material", option BB, TD
Ra_{max} 0.38 µm electropolished: order code for "Measuring tube material", option BC, TG

1) The connection corresponds to the hygienic clamp dimensions according to ASME BPE.

½" Tri-Clamp, for pipe according to DIN 11866 series C 1.4435 (316L) Order code for "Process connection", option FCW				
DN [mm]	Clamp [in]	A [mm]	B [mm]	L [mm]
15	½	25.0	9.40	466

Ra_{max} 0.76 µm: order code for "Measuring tube material", option BB, TD

¾" Tri-Clamp, for pipe according to DIN 11866 series C 1.4435 (316L) Order code for "Process connection", option FFW				
DN [mm]	Clamp [in]	A [mm]	B [mm]	L [mm]
8	¾	25.0	15.75	362

Ra_{max} 0.76 µm: order code for "Measuring tube material", option BB, TD
Ra_{max} 0.38 µm electropolished: order code for "Measuring tube material", option BC, TG

**1" Tri-Clamp, for pipe according to DIN 11866 series C
1.4435 (316L)**
Order code for "Process connection", option FPW

DN [mm]	Clamp [in]	A [mm]	B [mm]	L [mm]
8	1 ¹⁾	50.4	22.10	362
15	1 ¹⁾	50.4	22.10	466

Ra_{max} 0.76 µm: order code for "Measuring tube material", option BB, TD
Ra_{max} 0.38 µm electropolished: order code for "Measuring tube material", option BC, TG

1) The connection corresponds to the hygienic clamp dimensions according to ASME BPE.

**Tri-Clamp eccentric, for pipe according to DIN 11866 series C
1.4435 (316L)**

DN [mm]	Order code for "Process connection", option	Clamp [in]	A [mm]	B [mm]	L [mm]
8	FEB	½	25.0	9.40	362
15	FED	¾	25.0	15.75	466
25	FEF	1 ¹⁾	50.4	22.10	606
40	FEH	1½ ¹⁾	50.4	34.80	738
50	FEK	2 ¹⁾	63.9	47.50	860

Ra_{max} 0.76 µm: order code for "Measuring tube material", option BB, TD
Ra_{max} 0.38 µm electropolished: order code for "Measuring tube material", option BC, TG
Additional information regarding "Eccentric clamps"

1) The connection corresponds to the hygienic clamp dimensions according to ASME BPE.

Clamp connection DIN 32676, ISO 2852

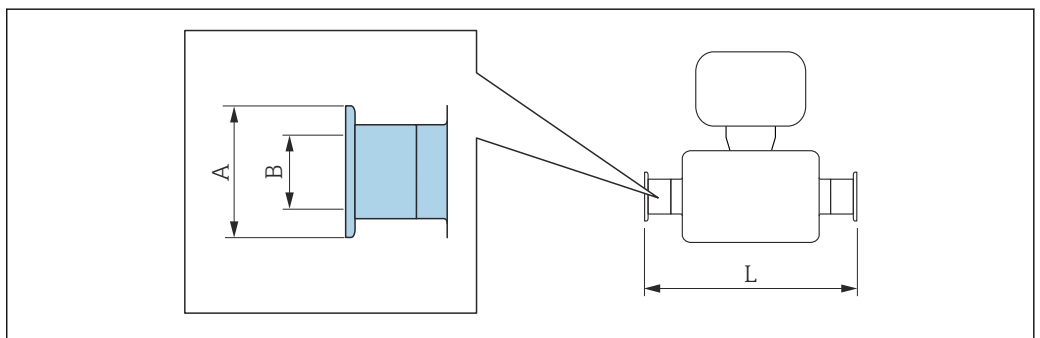

A0015625

i Length tolerance for dimension L in mm:
+1.5 / -2.0

**Clamp DIN 32676, for pipe according to DIN 11866 series A
1.4435 (316L)**
Order code for "Process connection", option KPW

DN [mm]	A [mm]	B [mm]	L [mm]
8	34.0	16.00	362
15	34.0	16.00	466
25	50.5	26.00	606

Clamp DIN 32676, for pipe according to DIN 11866 series A 1.4435 (316L)			
<i>Order code for "Process connection", option KPW</i>			
DN [mm]	A [mm]	B [mm]	L [mm]
40	50.5	38.00	732
50	64.0	50.00	854

Ra_{max} 0.76 µm: order code for "Measuring tube material", option BB, TD
Ra_{max} 0.38 µm electropolished: order code for "Measuring tube material", option BC, TG

Clamp ISO 2852 , for pipe according to ISO 2037 1.4435 (316L)			
<i>Order code for "Process connection", option JSA</i>			
DN [mm]	A [mm]	B [mm]	L [mm]
8	50.5	22.6	362
15	50.5	22.6	466
25	50.5	22.6	606
40	50.5	35.6	731
50	64.0	48.6	853

Ra_{max} 0.76 µm: order code for "Measuring tube material", option BB, TD
Ra_{max} 0.38 µm electropolished: order code for "Measuring tube material", option BC, TG

Clamp ISO 2852, for pipe according to DIN11866 series B 1.4435 (316L)			
<i>Order code for "Process connection", option JSC</i>			
DN [mm]	A [mm]	B [mm]	L [mm]
8	34.0	14.00	362
15	34.0	18.10	466
25	50.5	29.70	606
40	64.0	44.30	731
50	77.5	56.30	853

Ra_{max} 0.76 µm: order code for "Measuring tube material", option BB, TD
Ra_{max} 0.38 µm electropolished: order code for "Measuring tube material", option BC, TG

Clamp connection DIN 11864-3

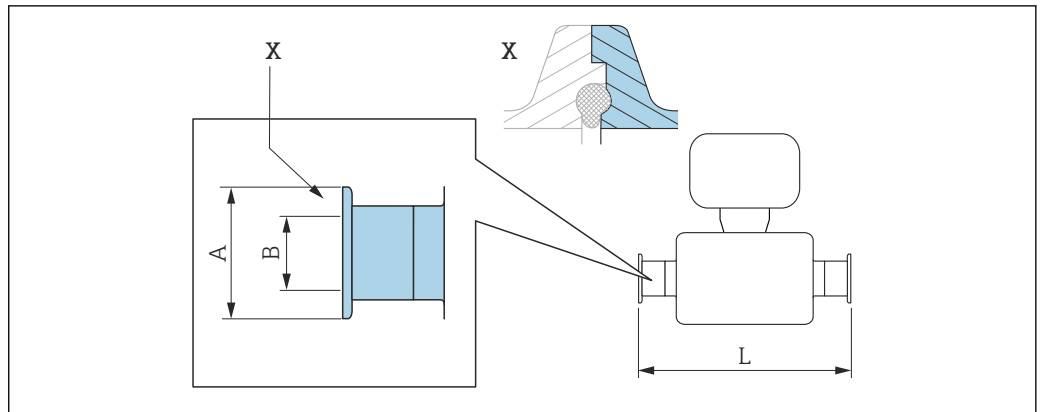

A0016903

39 Detail X: Asymmetrical process connection; the part shown in blue is provided by the supplier.

i Length tolerance for dimension L in mm:
+1.5 / -2.0

Clamp DIN 11864-3 Form A, with notch, for pipe according to DIN 11866 series A 1.4435 (316L)

Order code for "Process connection", option KLW

DN [mm]	A [mm]	B [mm]	L [mm]
8	34.0	16.05	370
15	34.0	16.05	474
25	50.5	26.05	614
40	64.0	38.05	738
50	77.5	50.05	853

Ra max 0.76 µm: order code for "Measuring tube material", option BB, TD

Ra max 0.38 µm electropolished: order code for "Measuring tube material", option BC, TG

BBS clamp connection

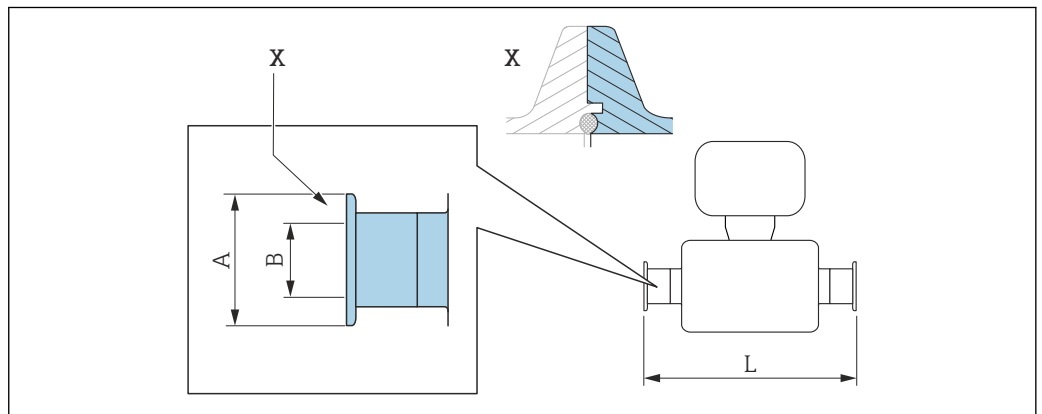

A0016908

40 Detail X: Asymmetrical process connection; the part shown in blue is provided by the supplier.

i Length tolerance for dimension L in mm:
+1.5 / -2.0

BBS Quick Connect (sterile orbital), for pipe according to DIN 11866 series A, female 1.4435 (316L)

Order code for "Process connection", option BSE

DN [mm]	A [mm]	B [mm]	L [mm]
8	25.0	10.00	362
15	50.5	16.00	466
25	50.5	26.00	606
40	64.0	38.00	732
50	77.5	50.00	854

Ra_{max} 0.76 µm: order code for "Measuring tube material", option BB, TDRa_{max} 0.38 µm electropolished: order code for "Measuring tube material", option BC, TG**BBS Quick Connect (sterile orbital) for pipe according to DIN11866 series B, female 1.4435 (316L)**

Order code for "Process connection", option BSJ

DN [mm]	A [mm]	B [mm]	L [mm]
8	25.0	14.00	362
15	50.5	18.10	466
25	50.5	29.70	606
40	64.0	44.30	738
50	77.5	56.30	860

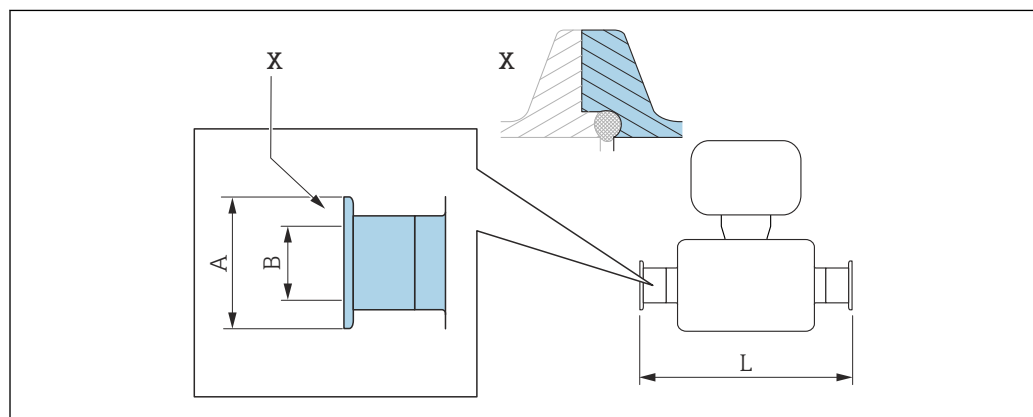
Ra_{max} 0.76 µm: order code for "Measuring tube material", option BB, TDRa_{max} 0.38 µm electropolished: order code for "Measuring tube material", option BC, TG*Neumo BioConnect clamp connection*

A0016905

41 Detail X: Asymmetrical process connection; the part shown in blue is provided by the supplier.

i Length tolerance for dimension L in mm:
+1.5 / -2.0

Clamp, Neumo BioConnect (sterile orbital), for pipe according to DIN 11866 series A, clamp form R 1.4435 (316L)
Order code for "Process connection", option BSA

DN [mm]	A [mm]	B [mm]	L [mm]
8	25.0	10.00	362
15	25.0	16.00	466
25	50.4	26.00	606
40	64.0	38.00	732
50	77.4	50.00	854

Ra_{max} 0.76 µm: order code for "Measuring tube material", option BB, TD
 Ra_{max} 0.38 µm electropolished: order code for "Measuring tube material", option BC, TG

Eccentric clamp connection DIN 32676, ISO 2852

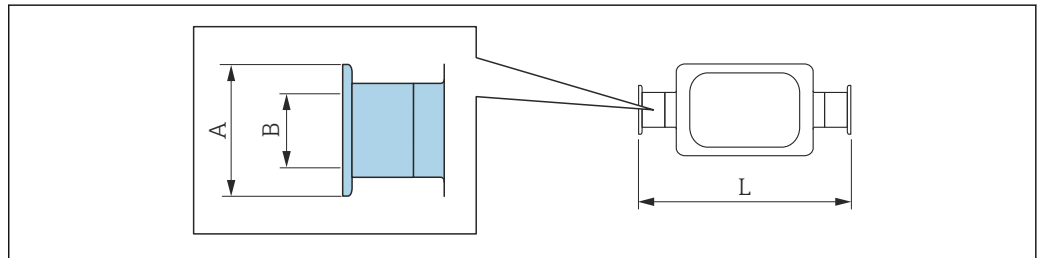

A0016543

 Length tolerance for dimension L in mm:
 +1.5 / -2.0

Eccentric clamp DIN 32676, for pipe according to DIN 11866 series A 1.4435 (316L)
Order code for "Process connection", option KRW

DN [mm]	A [mm]	B [mm]	L [mm]
8	34.0	10.00	362
15	34.0	16.00	466
25	50.5	26.00	606
50	64.0	50.00	860

Ra_{max} 0.76 µm: order code for "Measuring tube material", option BB, TD
 Ra_{max} 0.38 µm electropolished: order code for "Measuring tube material", option BC, TG

Eccentric clamp ISO 2852, for pipe according to DIN11866 series B 1.4435 (316L)
Order code for "Process connection", option JEC

DN [mm]	A [mm]	B [mm]	L [mm]
8	34.0	10.30	362
15	34.0	14.00	466
25	34.0	18.10	606
40	50.5	29.70	738

Eccentric clamp ISO 2852, for pipe according to DIN11866 series B 1.4435 (316L)			
Order code for "Process connection", option JEC			
DN [mm]	A [mm]	B [mm]	L [mm]
50	64.0	44.30	853

Ra_{max} 0.76 µm: order code for "Measuring tube material", option BB, TD
Ra_{max} 0.38 µm electropolished: order code for "Measuring tube material", option BC, TG
Additional information regarding "Eccentric clamps"

Eccentric clamp ISO 2852, for pipe according to DIN11866 series B, for connection to DN15 pipes 1.4435 (316L)			
Order code for "Process connection", option JED			
DN [mm]	A [mm]	B [mm]	L [mm]
25	50.5	18.10	606

Ra_{max} 0.76 µm: order code for "Measuring tube material", option BB, TD
Ra_{max} 0.38 µm electropolished: order code for "Measuring tube material", option BC, TG
Additional information regarding "Eccentric clamps"

Eccentric clamp connection DIN 11864-3

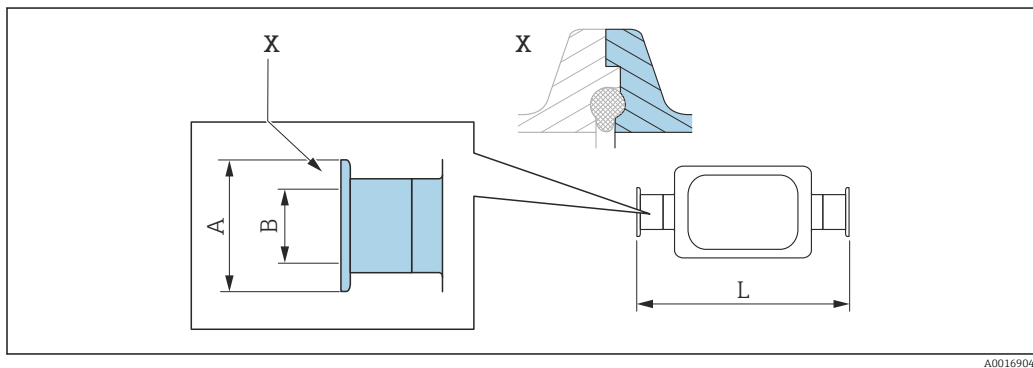

42 Detail X: Asymmetrical process connection; the part shown in blue is provided by the supplier.

 Length tolerance for dimension L in mm:
+1.5 / -2.0

Eccentric clamp DIN 11864-3 Form A, with notch, for pipe according to DIN 11866 series A 1.4435 (316L)			
Order code for "Process connection", option KNW			
DN [mm]	A [mm]	B [mm]	L [mm]
8	34.0	10.00	370
15	34.0	16.00	474
25	50.5	26.00	624
50	77.5	50.00	869

Ra_{max} 0.76 µm: order code for "Measuring tube material", option BB, TD
Ra_{max} 0.38 µm electropolished: order code for "Measuring tube material", option BC, TG
Additional information regarding "Eccentric clamps"

BBS eccentric clamp connection

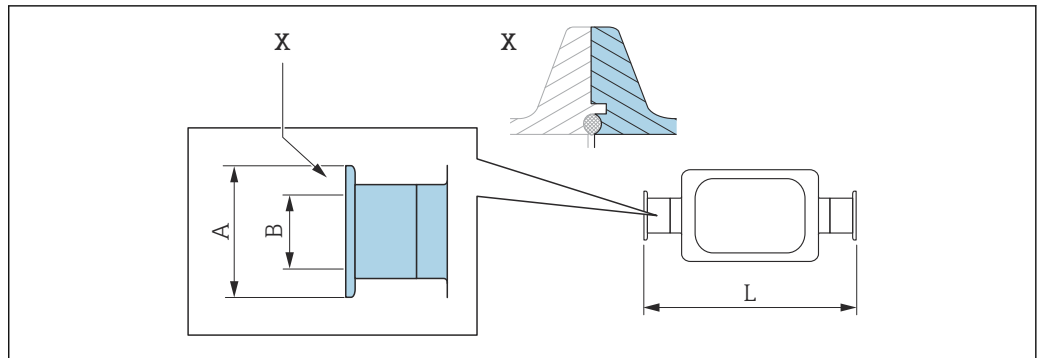

A0016909

43 Detail X: Asymmetrical process connection; the part shown in blue is provided by the supplier.

i Length tolerance for dimension L in mm:
+1.5 / -2.0

BBS Quick Connect (sterile orbital), eccentric, for pipe according to DIN11866 series A, female 1.4435 (316L)			
<i>Order code for "Process connection", option BEJ</i>			
DN [mm]	A [mm]	B [mm]	L [mm]
8	25.0	10.00	362
15	50.5	16.00	466
25	50.5	26.00	606
50	77.5	50.00	860

Ra_{max} 0.76 µm: order code for "Measuring tube material", option BB, TD
 Ra_{max} 0.38 µm electropolished: order code for "Measuring tube material", option BC, TG
 Additional information regarding "Eccentric clamps"

BBS Quick Connect (sterile orbital), eccentric, for pipe according to DIN11866 series B, female 1.4435 (316L)			
<i>Order code for "Process connection", option BEK</i>			
DN [mm]	A [mm]	B [mm]	L [mm]
8	25.0	10.30	362
15	50.5	14.00	466
25	50.5	18.10	606
40	50.5	29.70	738
50	64.0	44.30	860

Ra_{max} 0.76 µm: order code for "Measuring tube material", option BB, TD
 Ra_{max} 0.38 µm electropolished: order code for "Measuring tube material", option BC, TG
 Additional information regarding "Eccentric clamps"

Neumo BioConnect eccentric clamp connection

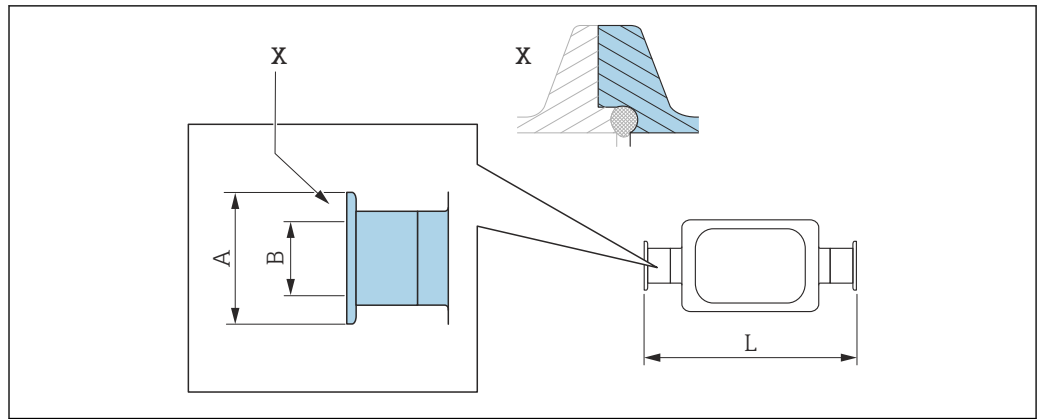

A0016906

44 Detail X: Asymmetrical process connection; the part shown in blue is provided by the supplier.

i Length tolerance for dimension L in mm:
+1.5 / -2.0

Neumo BioConnect eccentric clamp connection, for pipe according to DIN 11866 series C, clamp form R 1.4435 (316L) Order code for "Process connection", option BEA			
DN [mm]	A [mm]	B [mm]	L [mm]
8	25	10	362
15	25	16	466
25	50.4	26	610
50	77.4	50	859

Ra_{max} 0.76 µm: order code for "Measuring tube material", option BB, TD
 Ra_{max} 0.38 µm electropolished: order code for "Measuring tube material", option BC, TG
 Additional information regarding "Eccentric clamps"

Couplings

Thread DIN 11851, DIN 11864-1, SMS 1145, BBS

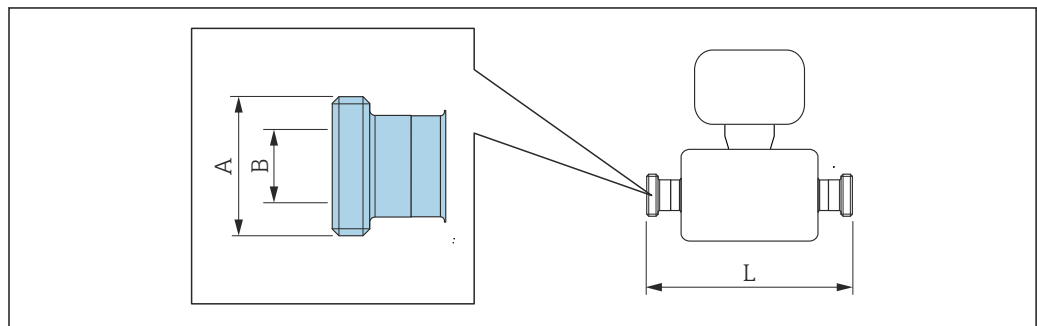

A0015628

i Length tolerance for dimension L in mm:
+1.5 / -2.0

Thread DIN 11851, for pipe according to DIN 11866 series A 1.4435 (316L)			
<i>Order code for "Process connection", option KCW</i>			
DN [mm]	A [mm]	B [mm]	L [mm]
8	Rd $34 \times \frac{1}{8}$	16	362
15	Rd $34 \times \frac{1}{8}$	16	466
25	Rd $52 \times \frac{1}{6}$	26	606
40	Rd $65 \times \frac{1}{6}$	38	738
50	Rd $78 \times \frac{1}{6}$	50	864

Ra_{max} 0.76 µm: order code for "Measuring tube material", option BB, TD
Ra_{max} 0.38 µm electropolished: order code for "Measuring tube material", option BC, TG

Thread DIN 11851, Rd $28 \times \frac{1}{8}$", for pipe according to DIN 11866 series A 1.4435 (316L)			
<i>Order code for "Process connection", option KAW</i>			
DN [mm]	A [mm]	B [mm]	L [mm]
8	Rd $28 \times \frac{1}{8}$ "	10.00	362
15	Rd $28 \times \frac{1}{8}$ "	10.00	466

Ra_{max} 0.76 µm: order code for "Measuring tube material", option BB, TD
Ra_{max} 0.38 µm electropolished: order code for "Measuring tube material", option BC, TG

Thread DIN 11864-1 Form A, for pipe according to DIN 11866 series A 1.4435 (316L)			
<i>Order code for "Process connection", option KGW</i>			
DN [mm]	A [mm]	B [mm]	L [mm]
8	Rd $34 \times \frac{1}{8}$ "	16	362
15	Rd $34 \times \frac{1}{8}$ "	16	466
25	Rd $52 \times \frac{1}{6}$ "	26	620
40	Rd $65 \times \frac{1}{6}$ "	38	738
50	Rd $78 \times \frac{1}{6}$ "	50	864

Ra_{max} 0.76 µm: order code for "Measuring tube material", option BB, TD
Ra_{max} 0.38 µm electropolished: order code for "Measuring tube material", option BC, TG

Thread SMS 1145 1.4435 (316L)			
<i>Order code for "Process connection", option SAW</i>			
DN [mm]	A [mm]	B [mm]	L [mm]
8	Rd $40 \times \frac{1}{6}$ "	22.50	362
15	Rd $40 \times \frac{1}{6}$ "	22.50	466
25	Rd $40 \times \frac{1}{6}$ "	22.50	606
40	Rd $60 \times \frac{1}{6}$ "	35.50	742
50	Rd $70 \times \frac{1}{6}$ "	48.50	864

Ra_{max} 0.76 µm: order code for "Measuring tube material", option BB, TD
Ra_{max} 0.38 µm electropolished: order code for "Measuring tube material", option BC, TG

BBS thread (sterile orbital), for pipe according to DIN 11866 series A 1.4435 (316L)			
<i>Order code for "Process connection", option BSC</i>			
DN [mm]	A [mm]	B [mm]	L [mm]
8	M22 × 1.5	10.00	362
15	M30 × 2	16.00	466
25	M42 × 2	26.00	606
40	M52 × 2	38.00	732
50	M68 × 2	50.00	854

Ra_{max} 0.76 µm: order code for "Measuring tube material", option BB, TD
Ra_{max} 0.38 µm electropolished: order code for "Measuring tube material", option BC, TG

BBS thread (sterile orbital), for pipe according to DIN 11866 series B 1.4435 (316L)			
<i>Order code for "Process connection", option BSD</i>			
DN [mm]	A [mm]	B [mm]	L [mm]
8	M26 × 1.5	14.00	362
15	M30 × 2	18.10	466
25	M42 × 2	29.70	606
40	M56 × 2	44.30	738
50	M68 × 2	56.30	860

Ra_{max} 0.76 µm: order code for "Measuring tube material", option BB, TD
Ra_{max} 0.38 µm electropolished: order code for "Measuring tube material", option BC, TG

Thread ISO 2853

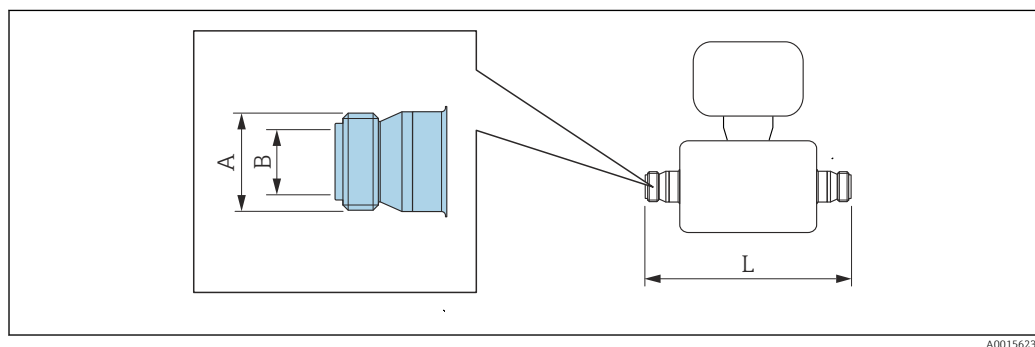

i Length tolerance for dimension L in mm:
+1.5 / -2.0

Thread ISO 2853, for pipe according to ISO 2037 1.4435 (316L)			
<i>Order code for "Process connection", option JSD</i>			
DN [mm]	A [mm]	B [mm]	L [mm]
8	37.13	22.60	370
15	37.13	22.60	474
25	37.13	22.60	614

Thread ISO 2853, for pipe according to ISO 2037 1.4435 (316L) <i>Order code for "Process connection", option JSD</i>			
DN [mm]	A [mm]	B [mm]	L [mm]
40	50.65	35.60	742
50	64.10	48.60	864
Ra _{max} 0.76 µm: order code for "Measuring tube material", option BB, TD Ra _{max} 0.38 µm electropolished: order code for "Measuring tube material", option BC, TG			

Safety Barrier Promass 100

Top-hat rail EN 60715:

- TH 35 x 7.5
- TH 35 x 15

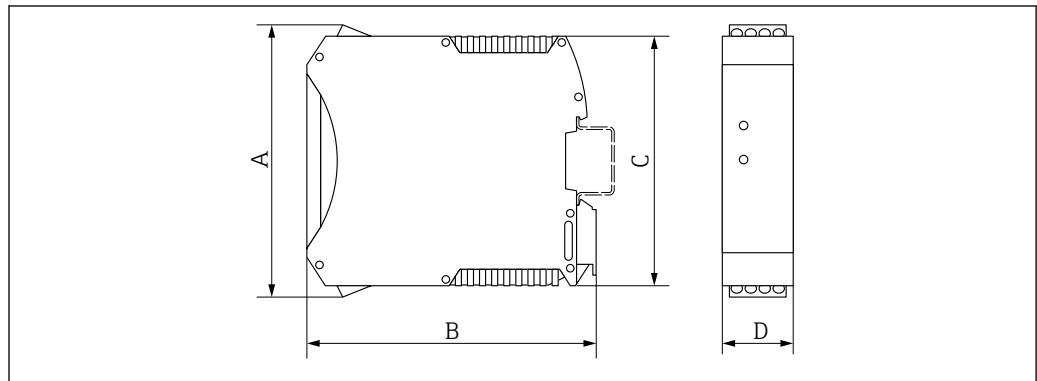

A0016777

A	B	C	D
[mm]	[mm]	[mm]	[mm]
108	114.5	99	22.5

Accessories

Rinse connections

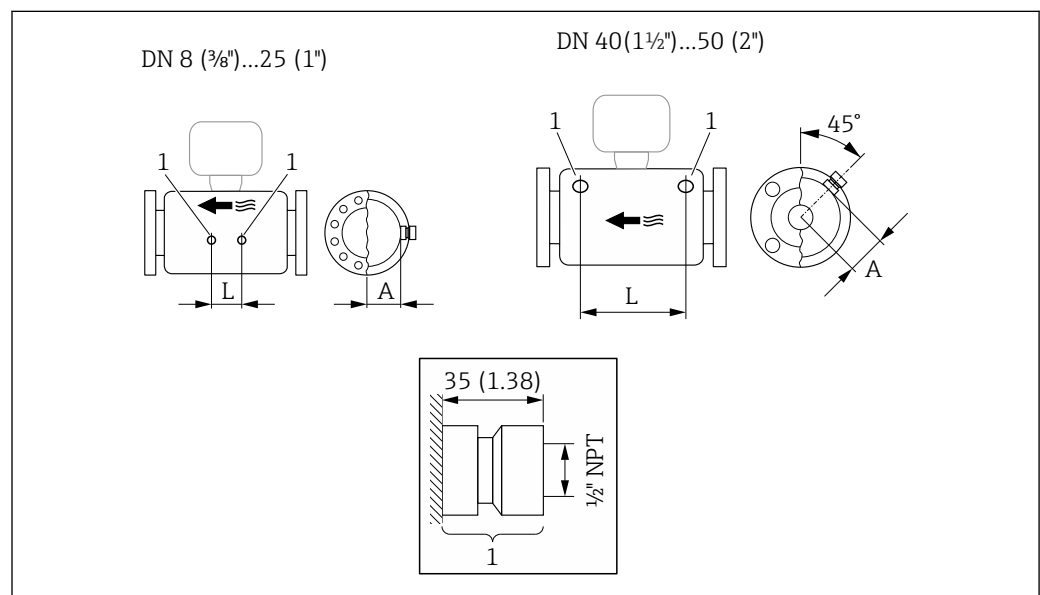

A0029971

45

1 Connection nipple for purge connections: order code for "Sensor options", option CH "Purge connection"

DN	A	L
[mm]	[mm]	[mm]
8	47	110
15	47	204
25	47	348

DN	A	L
[mm]	[mm]	[mm]
40	68.15	418
50	81.65	473

Dimensions in US units

Compact version

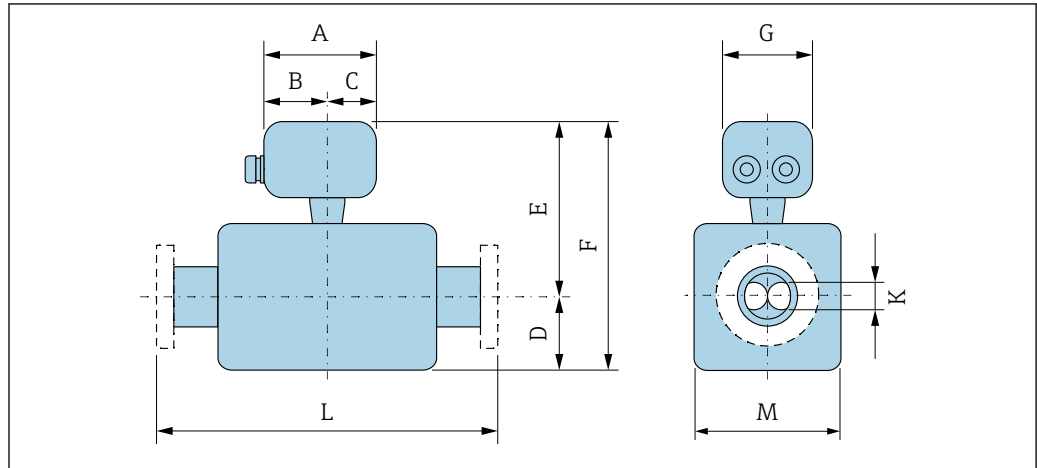

Order code for "Housing", option A "Compact, aluminum, coated"

DN [in]	A [in]	B [in]	C [in]	D [in]	E ^{1) 2)} [in]	F ^{1) 2)} [in]	G [in]	K [in]	L [in]	M [in]
3/8	5.81	3.68	2.13	4.25	7.52	11.8	5.35	0.33	³⁾	3.62
1/2	5.81	3.68	2.13	4.25	7.52	11.8	5.35	0.47	³⁾	3.62
1	5.81	3.68	2.13	4.76	7.52	12.3	5.35	0.69	³⁾	3.62
1 1/2	5.81	3.68	2.13	6.81	8.46	15.3	5.35	1.02	³⁾	5.20
2	5.81	3.68	2.13	9.49	8.90	18.4	5.35	1.59	³⁾	6.57

- 1) If using an extension neck for the extended temperature range, order code for "Sensor option", option CG and order code for "Measuring tube material", option TD, TG: values +2.76 in
- 2) If using a display, order code for "Display; Operation", option B: values +1.1 in
- 3) Depending on the process connection

Order code for "Housing", option B "Compact hygienic, stainless"

DN [in]	A [in]	B [in]	C [in]	D [in]	E ^{1) 2)} [in]	F ^{1) 2)} [in]	G [in]	K [in]	L [in]	M [in]
3/8	5.39	3.07	2.31	4.25	7.32	11.6	5.26	0.33	³⁾	3.62
1/2	5.39	3.07	2.31	4.25	7.32	11.6	5.26	0.47	³⁾	3.62
1	5.39	3.07	2.31	4.76	7.32	12.1	5.26	0.69	³⁾	3.62
1 1/2	5.39	3.07	2.31	6.81	8.27	15.1	5.26	1.02	³⁾	5.20
2	5.39	3.07	2.31	9.49	8.70	18.2	5.26	1.59	³⁾	6.57

- 1) If using an extension neck for the extended temperature range, order code for "Sensor option", option CG and order code for "Measuring tube material", option TD, TG: values +2.76 in
- 2) If using a display, order code for "Display; Operation", option B: values +0.55 in
- 3) Depending on the process connection

Order code for "Housing", option C "Ultra-compact hygienic, stainless"

DN [in]	A [in]	B [in]	C [in]	D [in]	E ^{1) 2)} [in]	F ^{1) 2)} [in]	G [in]	K [in]	L [in]	M [in]
3/8	4.87	2.67	2.20	4.25	7.32	11.57	4.39	0.33	³⁾	3.62
1/2	4.87	2.67	2.20	4.25	7.32	11.6	4.39	0.47	³⁾	3.62
1	4.87	2.67	2.20	4.76	7.32	12.1	4.39	0.69	³⁾	3.62

DN [in]	A [in]	B [in]	C [in]	D [in]	E ^{1) 2)} [in]	F ^{1) 2)} [in]	G [in]	K [in]	L [in]	M [in]
1½	4.87	2.67	2.20	6.81	8.27	15.1	4.39	1.02	³⁾	5.20
2	4.87	2.67	2.20	9.49	8.70	18.2	4.39	1.59	³⁾	6.57

- 1) If using an extension neck for the extended temperature range, order code for "Sensor option", option CG and order code for "Measuring tube material", option TD, TG: values +2.76 in
- 2) If using a display, order code for "Display; Operation", option B: values +0.55 in
- 3) Depending on the process connection

Flange connections

Fixed flange ASME B16.5

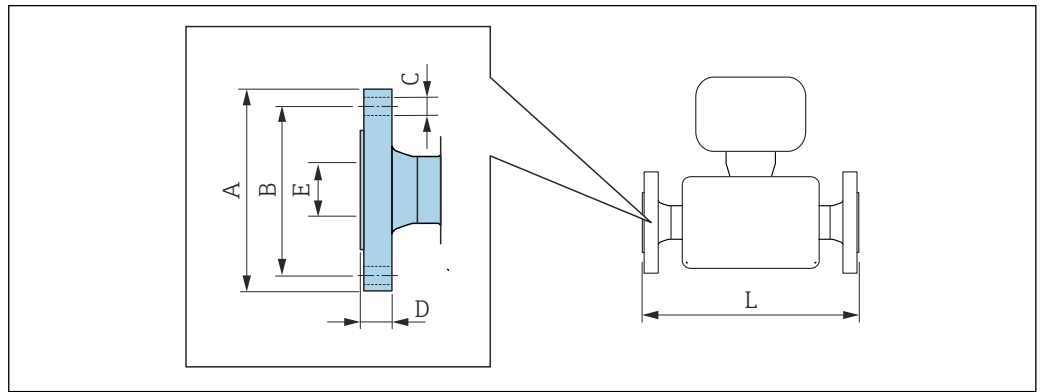

A0015621

i Length tolerance for dimension L in inch:
+0.06 / -0.08

Flange according to ASME B16.5: Cl 150 1.4404 (F316/F316L)						
<i>Order code for "Process connection", option AAW</i>						
DN [in]	A [in]	B [in]	C [in]	D [in]	E [in]	L [in]
¾ ¹⁾	3.54	2.37	4 × Ø0.62	0.44	0.62	13.23
½	3.54	2.37	4 × Ø0.62	0.44	0.62	17.32
1	4.33	3.13	4 × Ø0.62	0.56	1.05	22.83
1½	4.92	3.87	4 × Ø0.62	0.69	1.61	27.83
2	5.91	4.75	4 × Ø0.75	0.75	2.07	32.6

Surface roughness (flange): Ra 3.2 to 6.3 µm

- 1) DN ¾" with DN ½" flanges as standard

Neumo BioConnect fixed flange

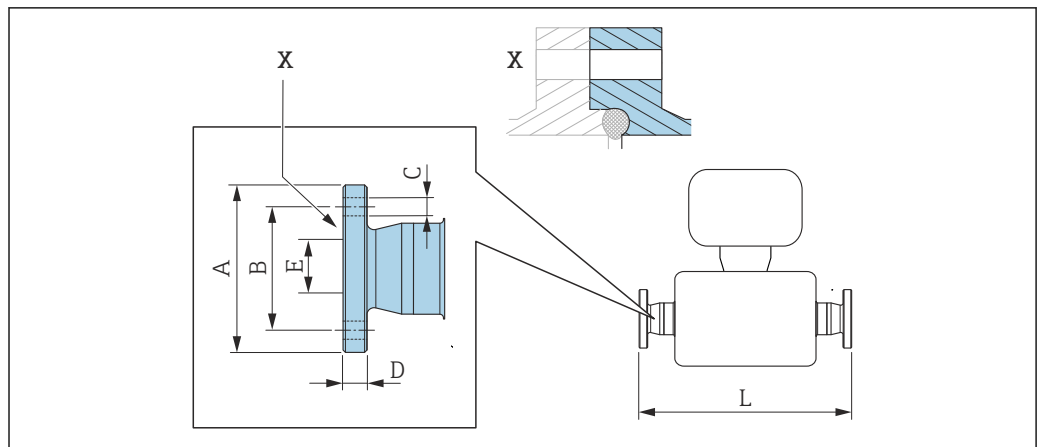

A0016907

46 Detail X: Asymmetrical process connection; the part shown in blue is provided by the supplier.

i Length tolerance for dimension L in inch:
+0.06 / -0.08

Neumo BioConnect flange (sterile orbital), for pipe according to DIN 11866 series A, flange form R 1.4435 (316L) Order code for "Process connection", option BSB						
DN [in]	A [in]	B [in]	C [in]	D [in]	E [in]	L [in]
3/8	2.56	1.77	4 × Ø0.35	0.39	0.39	15.12
1/2	2.95	2.17	4 × Ø0.35	0.39	0.63	19.21
1	3.35	2.56	4 × Ø0.35	0.47	1.02	24.65
1 1/2	3.94	3.15	4 × Ø0.35	0.47	1.5	29.65
2	4.33	3.54	4 × Ø0.35	0.55	1.97	34.53

Ra_{max} 30 µin: order code for "Measuring tube material", option BB, TD
Ra_{max} 15 µin electropolished: order code for "Measuring tube material", option BC, TG

Clamp connections

Tri-Clamp

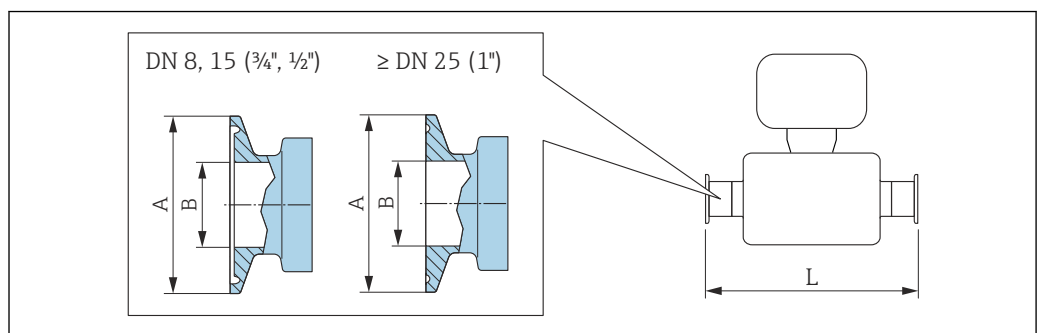

A0023342

47 Engineering unit mm (in)

i Length tolerance for dimension L in inch:
+0.06 / -0.08

Tri-Clamp; for pipe according to DIN 11866 series C 1.4435 (316L)				
<i>Order code for "Process connection", option FHW</i>				
DN [in]	Clamp [in]	A [in]	B [in]	L [in]
3/8	1/2	0.98	0.37	14.25
1/2	3/4	0.98	0.62	18.35
1	1	1.98	0.87	23.86
1 1/2	1 1/2	1.98	1.37	28.78
2	2	2.52	1.87	33.58

Ra_{max} 30 µin: order code for "Measuring tube material", option BB, TD
Ra_{max} 15 µin electropolished: order code for "Measuring tube material", option BC, TG

1/2" Tri-Clamp; for pipe according to DIN 11866 series C 1.4435 (316L)				
<i>Order code for "Process connection", option FCW</i>				
DN [in]	Clamp [in]	A [in]	B [in]	L [in]
1/2	1/2	0.98	0.37	18.35

Ra_{max} 30 µin: order code for "Measuring tube material", option BB, TD

3/4" Tri-Clamp; for pipe according to DIN 11866 series C 1.4435 (316L)				
<i>Order code for "Process connection", option FFW</i>				
DN [in]	Clamp [in]	A [in]	B [in]	L [in]
3/8	3/4	0.98	0.62	14.25

Ra_{max} 30 µin: order code for "Measuring tube material", option BB, TD
Ra_{max} 15 µin electropolished: order code for "Measuring tube material", option BC, TG

1" Tri-Clamp; for pipe according to DIN 11866 series C 1.4435 (316L)				
<i>Order code for "Process connection", option FPW</i>				
DN [in]	Clamp [in]	A [in]	B [in]	L [in]
3/8	1	1.98	0.87	14.25
1/2	1	1.98	0.87	18.35

Ra_{max} 30 µin: order code for "Measuring tube material", option BB, TD
Ra_{max} 15 µin electropolished: order code for "Measuring tube material", option BC, TG

Tri-Clamp eccentric; for pipe according to DIN 11866 series C 1.4435 (316L)					
DN [in]	Order code for "Process connection", option	Clamp [in]	A [in]	B [in]	L [in]
3/8	FEB	1/2	0.98	0.37	14.25
1/2	FED	3/4	0.98	0.62	18.35
1	FEF	1	1.98	0.87	23.86
1 1/2	FEH	1 1/2	1.98	1.37	29.06

Tri-Clamp eccentric; for pipe according to DIN 11866 series C 1.4435 (316L)					
DN [in]	Order code for "Process connection", option	Clamp [in]	A [in]	B [in]	L [in]
2	FEK	2	2.52	1.87	33.86

Ra_{max} 30 µin: order code for "Measuring tube material", option BB, TD
Ra_{max} 15 µin electropolished: order code for "Measuring tube material", option BC, TG
Additional information regarding "Eccentric clamps"

Neumo BioConnect clamp connection

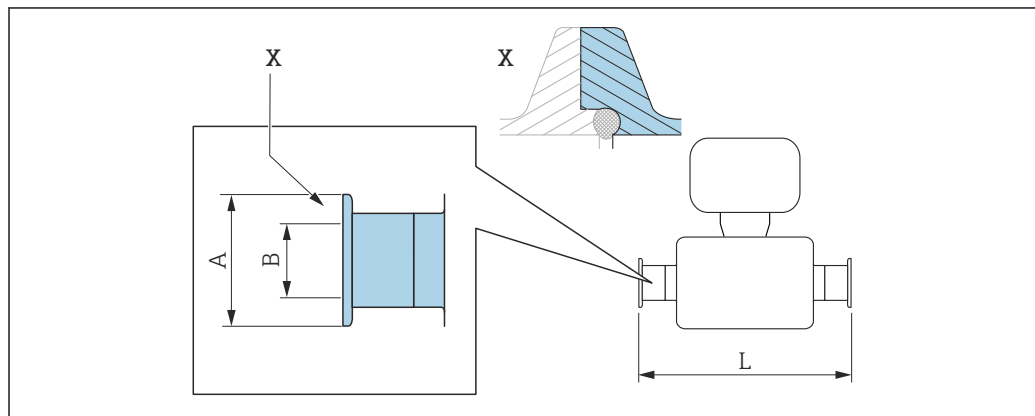

A0016905

48 Detail X: Asymmetrical process connection; the part shown in blue is provided by the supplier.

i Length tolerance for dimension L in inch:
+0.06 / -0.08

Clamp; Neumo BioConnect (sterile orbital), for pipe according to DIN 11866 series A, clamp form R 1.4435 (316L)			
Order code for "Process connection", option BSA			
DN [in]	A [in]	B [in]	L [in]
3/8	0.98	0.39	14.25
1/2	0.98	0.63	18.35
1	1.98	1.02	23.86
1 1/2	2.52	1.5	28.82
2	3.05	1.97	33.62

Ra_{max} 30 µin: order code for "Measuring tube material", option BB, TD
Ra_{max} 15 µin electropolished: order code for "Measuring tube material", option BC, TG

Neumo BioConnect eccentric clamp connection

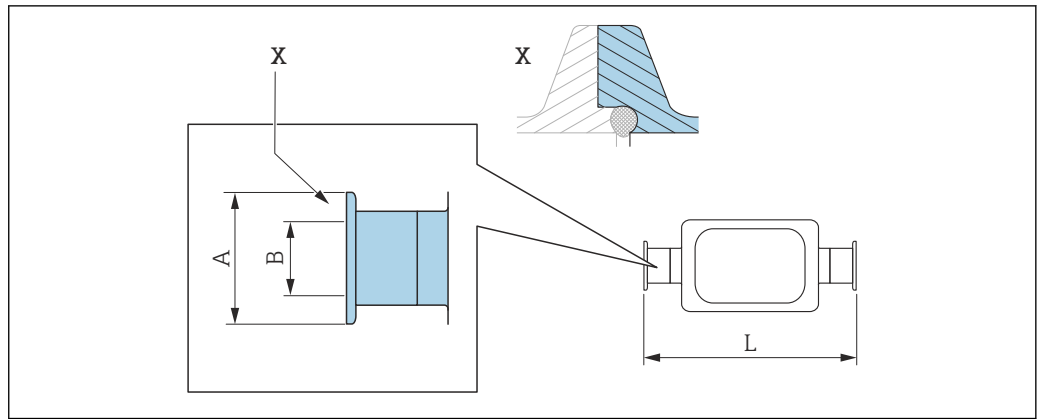

A0016906

49 Detail X: Asymmetrical process connection; the part shown in blue is provided by the supplier.

i Length tolerance for dimension L in inch:
+0.06 / -0.08

Neumo BioConnect eccentric clamp connection, for pipe according to DIN 11866 series C, clamp form R 1.4435 (316L)
Order code for "Process connection", option BEA

DN [in]	A [in]	B [in]	L [in]
3/8	0.98	0.39	14.25
1/2	0.98	0.63	18.35
1	1.98	1.02	24.02
2	3.05	1.97	43.39

Ra_{max} 30 µin: order code for "Measuring tube material", option BB, TD
Ra_{max} 15 µin electropolished: order code for "Measuring tube material", option BC, TG
Additional information regarding "Eccentric clamps"

Couplings

Thread SMS 1145

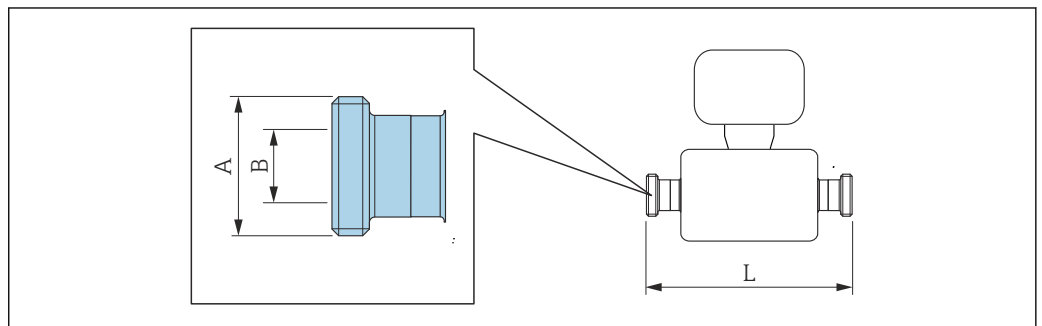

A0015628

i Length tolerance for dimension L in inch:
+0.06 / -0.08

Thread SMS 1145 1.4435 (316L) Order code for "Process connection", option SAW			
DN [in]	A [in]	B [in]	L [in]
3/8	Rd 40 × 1/6	0.89	14.25
1/2	Rd 40 × 1/6	0.89	18.35
1	Rd 40 × 1/6	0.89	23.86
1 1/2	Rd 60 × 1/6	1.4	29.21
2	Rd 70 × 1/6	1.91	34.02

Ra_{max} 30 µin: order code for "Measuring tube material", option BB, TD
 Ra_{max} 15 µin electropolished: order code for "Measuring tube material", option BC, TG

Safety Barrier Promass 100

Top-hat rail EN 60715:

- TH 35 x 7.5
- TH 35 x 15

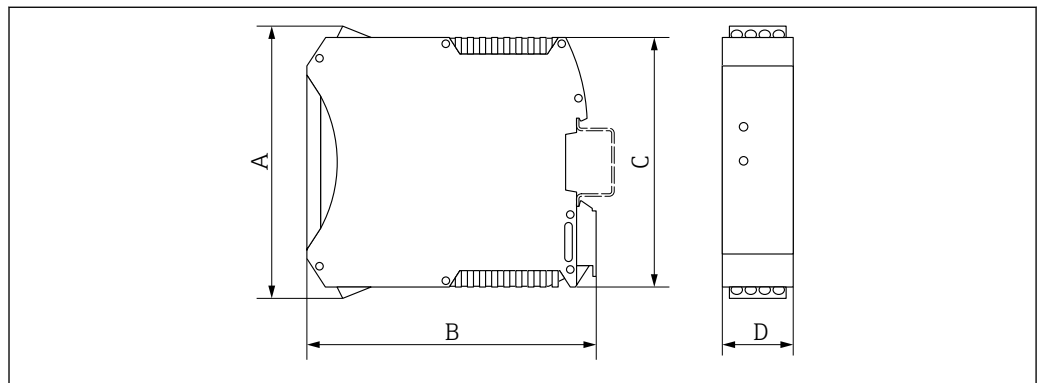

A0016777

A [in]	B [in]	C [in]	D [in]
4.25	4.51	3.9	0.89

Accessories

Rinse connections

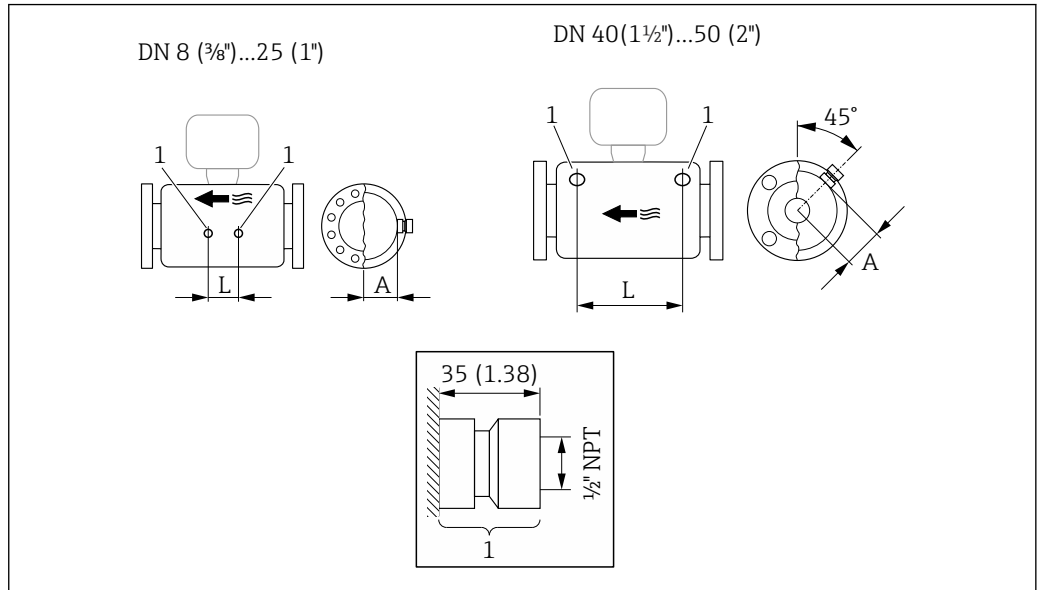

A0029971

50

1 Connection nipple for purge connections: order code for "Sensor options", option CH "Purge connection"

DN	A	L
[in]	[in]	[in]
3/8	1.85	4.33
1/2	1.85	8.03
1	1.85	13.7
1 1/2	2.683	16.46
2	3.215	18.62

Weight

All values (weight exclusive of packaging material) refer to devices with EN/DIN PN 40 flanges. Weight specifications including transmitter: order code for "Housing", option A "Compact, aluminum coated".

Weight in SI units

DN [mm]	Weight [kg]
8	12
15	14
25	20
40	36
50	59

Weight in US units

DN [in]	Weight [lbs]
3/8	26
1/2	31
1	44
1 1/2	79
2	130

Safety Barrier Promass 100

49 g (1.73 ounce)

Materials

Transmitter housing

- Order code for "Housing", option **A** "Compact, aluminum coated":
Aluminum, AlSi10Mg, coated
- Order code for "Housing", option **B** "Compact, hygienic, stainless":
Hygienic version, stainless steel 1.4301 (304)
- Order code for "Housing", option **C** "Ultra-compact, hygienic, stainless":
Hygienic version, stainless steel 1.4301 (304)
- Window material for optional local display (→ 87):
 - For order code for "Housing", option **A**: glass
 - For order code for "Housing", option **B** and **C**: plastic

Cable entries/cable glands

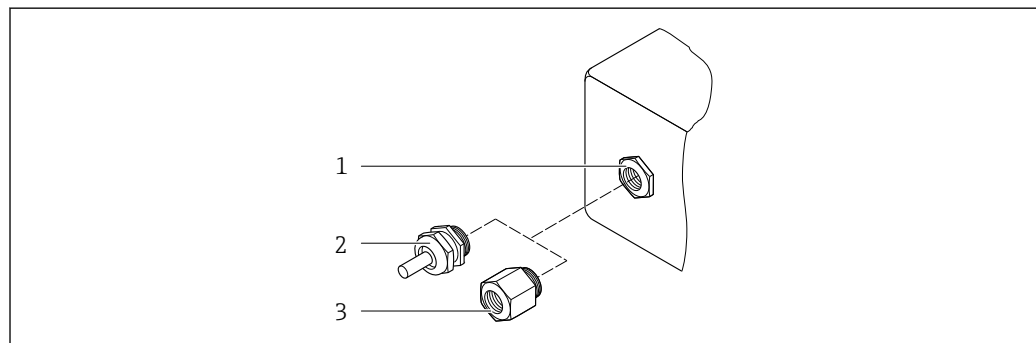

A0020640

51 Possible cable entries/cable glands

- 1 Female thread M20 × 1.5
- 2 Cable gland M20 × 1.5
- 3 Adapter for cable entry with female thread G 1/2" or NPT 1/2"

Order code for "Housing", option **A** "Compact, aluminum, coated"

The various cable entries are suitable for hazardous and non-hazardous areas.

Cable entry/cable gland	Material
Cable gland M20 × 1.5	Nickel-plated brass
Adapter for cable entry with internal thread G 1/2"	
Adapter for cable entry with internal thread NPT 1/2"	

Order code for "Housing", option B "Compact, hygienic, stainless"

The various cable entries are suitable for hazardous and non-hazardous areas.

Cable entry/cable gland	Material
Cable gland M20 × 1.5	Stainless steel, 1.4404 (316L)
Adapter for cable entry with internal thread G ½"	
Adapter for cable entry with internal thread NPT ½"	

Device plug

Electrical connection	Material
Plug M12x1	<ul style="list-style-type: none"> ▪ Socket: Stainless steel, 1.4404 (316L) ▪ Contact housing: Polyamide ▪ Contacts: Gold-plated brass

Sensor housing



- Acid and alkali-resistant outer surface
- Stainless steel 1.4301 (304)

Measuring tubes

Stainless steel, 1.4435 BN2 (316L)

Process connections

- Flanges according to EN 1092-1 (DIN 2501) / according to ASME B16.5 / according to JIS B2220: Stainless steel, 1.4404 (F316/F316L)
- All other process connections: Stainless steel, 1.4435 BN2 (316L)

 Available process connections →  86

Seals

Welded process connections without internal seals

Accessories

Protective cover

Stainless steel, 1.4404 (316L)

Safety Barrier Promass 100

Housing: Polyamide

Process connections

- Fixed flange connections:
 - EN 1092-1 (DIN 2501) flange
 - EN 1092-1 (DIN 2512N) flange
 - ASME B16.5 flange
 - JIS B2220 flange
 - DIN 11864-2 Form A flange, DIN 11866 series A, flange with notch
 - BBS flange small (sterile orbital), DIN 11866 series A, female
 - BBS flange small (sterile orbital), DIN 11866 series B, female
- Clamp connections:
 - Tri-Clamp (OD tubes), DIN 11866 series C
 - DIN 11864-3 Form A clamp, DIN 11866 series A, with notch
 - DIN 32676 clamp, DIN 11866 series A
 - ISO 2852 clamp, ISO 2037
 - ISO 2852 clamp, DIN 11866 series B
 - BBS Quick-Connect (sterile orbital), DIN 11866 series A, female
 - BBS Quick-Connect (sterile orbital), DIN 11866 series B, female
 - Neumo BioConnect clamp, DIN 11866 series A, clamp form R
- Eccentric clamp connection:
 - Eccen. Tri-Clamp, DIN 11866 series C
 - DIN 11864-3 Form A clamp, DIN 11866 series A, with notch
 - DIN 32676 clamp, DIN 11866 series A
 - ISO 2852 clamp, DIN 11866 series B
 - BBS Quick-Connect (sterile orbital), DIN 11866 series A, female
 - BBS Quick-Connect (sterile orbital), DIN 11866 series B, female
 - Neumo BioConnect clamp, DIN 11866 series A, clamp form R
- Thread:
 - DIN 11851 thread, DIN 11866 series A
 - SMS 1145 thread
 - ISO 2853 thread, ISO 2037
 - DIN 11864-1 Form A thread, DIN 11866 series A
 - BBS thread (sterile orbital), DIN 11866 series A
 - BBS thread (sterile orbital), DIN 11866 series B



Process connection materials

Surface roughness

All data refer to parts in contact with the medium. The following surface roughness categories can be ordered.

- $Ra_{max} = 0.76 \mu\text{m}$ (30 μin)
- $Ra_{max} = 0.38 \mu\text{m}$ (15 μin) electropolished
- Delta ferrite <1%

Operability

Operating concept**Operator-oriented menu structure for user-specific tasks**

- Commissioning
- Operation
- Diagnostics
- Expert level

Quick and safe commissioning

- Individual menus for applications
- Menu guidance with brief explanations of the individual parameter functions

Reliable operation

- Operation in the following languages:
 - Via "FieldCare", "DeviceCare" operating tool: English, German, French, Spanish, Italian, Chinese, Japanese
 - Via integrated Web browser (only available for device versions with HART, PROFIBUS DP, PROFINET and EtherNet/IP): English, German, French, Spanish, Italian, Dutch, Portuguese, Polish, Russian, Turkish, Chinese, Japanese, Bahasa (Indonesian), Vietnamese, Czech, Swedish, Korean
- Uniform operating philosophy applied to operating tools and Web browser
- If replacing the electronic module, transfer the device configuration via the plug-in memory (HistoROM DAT) which contains the process and measuring device data and the event logbook. No need to reconfigure.
For devices with Modbus RS485, the data recovery function is implemented without the plug-in memory (HistoROM DAT).

Efficient diagnostics increase measurement availability

- Troubleshooting measures can be called up via the operating tools and web browser
- Diverse simulation options
- Status indicated by several light emitting diodes (LEDs) on the electronic module in the housing compartment

Local display

 A local display is only available for device versions with the following communication protocols: HART, PROFIBUS-DP, PROFINET, EtherNet/IP

The local display is only available with the following device order code:
Order code for "Display; operation", option **B**: 4-line; illuminated, via communication

Display element

- 4-line liquid crystal display with 16 characters per line.
- White background lighting; switches to red in event of device errors.
- Format for displaying measured variables and status variables can be individually configured.
- Permitted ambient temperature for the display: -20 to +60 °C (-4 to +140 °F). The readability of the display may be impaired at temperatures outside the temperature range.

Remote operation

Via HART protocol

This communication interface is available in device versions with a HART output.

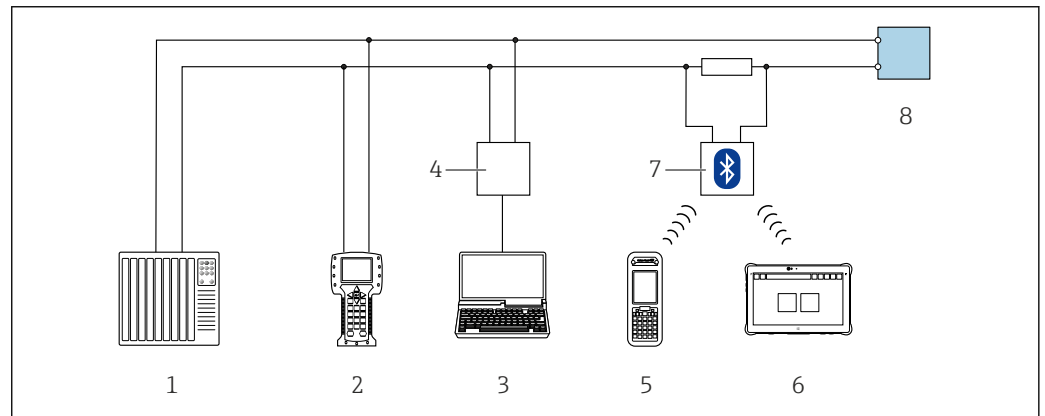

 52 Options for remote operation via HART protocol

- 1 Control system (e.g. PLC)
- 2 Field Communicator 475
- 3 Computer with operating tool (e.g. FieldCare, AMS Device Manager, SIMATIC PDM)
- 4 Commubox FXA195 (USB)
- 5 Field Xpert SFX350 or SFX370
- 6 Field Xpert SMT70
- 7 VIATOR Bluetooth modem with connecting cable
- 8 Transmitter

Via PROFIBUS DP network

This communication interface is available in device versions with PROFIBUS DP.

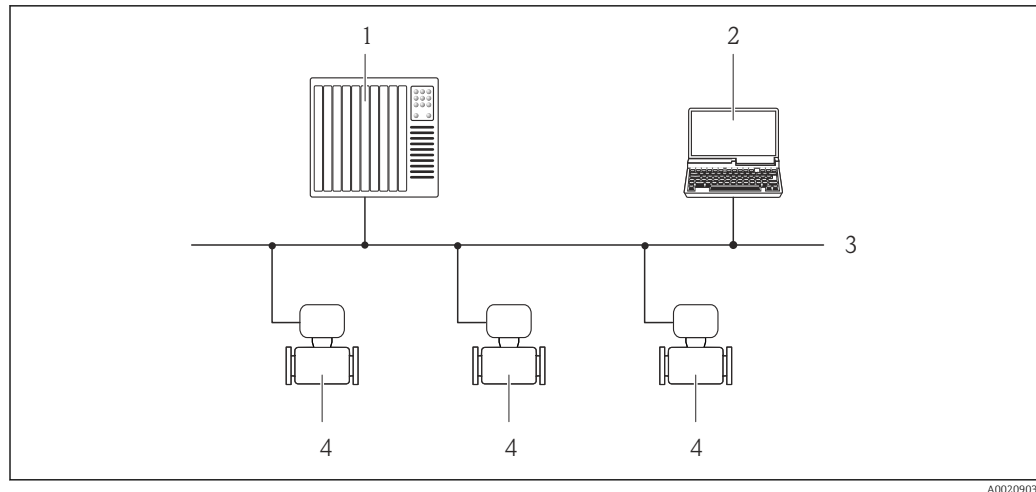

A0020903

53 Options for remote operation via PROFIBUS DP network

- 1 Automation system
- 2 Computer with PROFIBUS network card
- 3 PROFIBUS DP network
- 4 Measuring device

Via EtherNet/IP network

This communication interface is available in device versions with EtherNet/IP.

Star topology

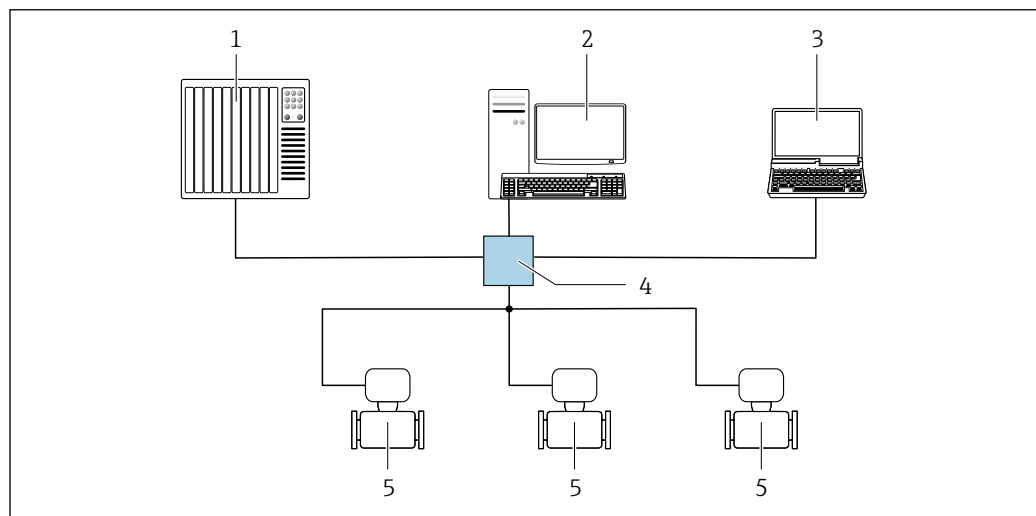

A0032078

54 Options for remote operation via EtherNet/IP network: star topology

- 1 Automation system, e.g. "RSLogix" (Rockwell Automation)
- 2 Workstation for measuring device operation: with Custom Add-On Profile for "RSLogix 5000" (Rockwell Automation) or with Electronic Data Sheet (EDS)
- 3 Computer with Web browser (e.g. Internet Explorer) for accessing the integrated Web server or computer with operating tool (e.g. FieldCare, DeviceCare) with COM DTM "CDI Communication TCP/IP"
- 4 Standard Ethernet switch, e.g. Scalance X204 (Siemens)
- 5 Measuring device

Via PROFINET network

This communication interface is available in device versions with PROFINET.

Star topology

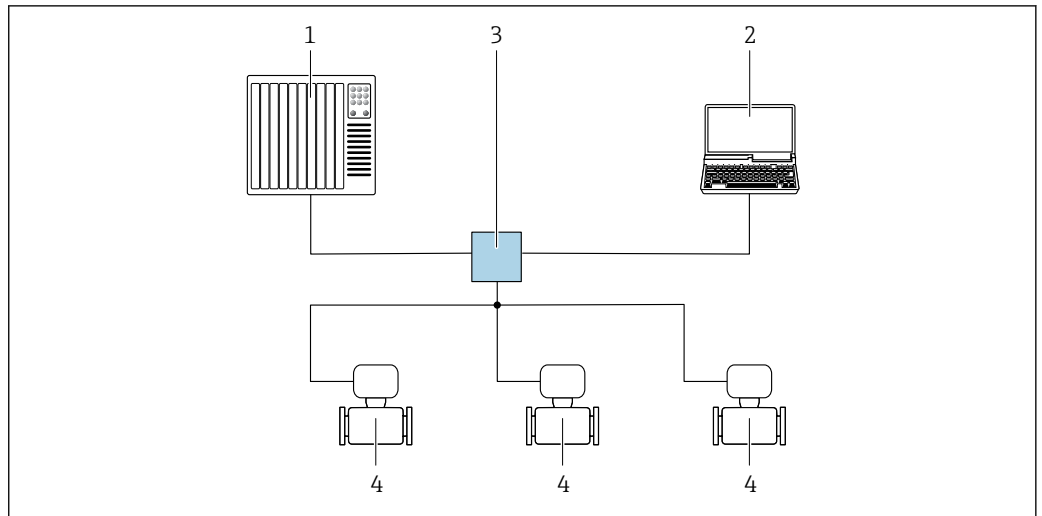

A0026545

55 Options for remote operation via PROFINET network: star topology

- 1 Automation system, e.g. Simatic S7 (Siemens)
- 2 Computer with Web browser (e.g. Internet Explorer) for accessing the integrated Web server or computer with operating tool (e.g. FieldCare, DeviceCare, SIMATIC PDM) with COM DTM "CDI Communication TCP/IP"
- 3 Standard Ethernet switch, e.g. Scalance X204 (Siemens)
- 4 Measuring device

Service interface

Via service interface (CDI-RJ45)

This communication interface is present in the following device version:

- Order code for "Output", option **B**: 4-20 mA HART, pulse/frequency/switch output
- Order code for "Output", option **L**: PROFIBUS DP
- Order code for "Output", option **N**: EtherNet/IP
- Order code for "Output", option **R**: PROFINET

HART

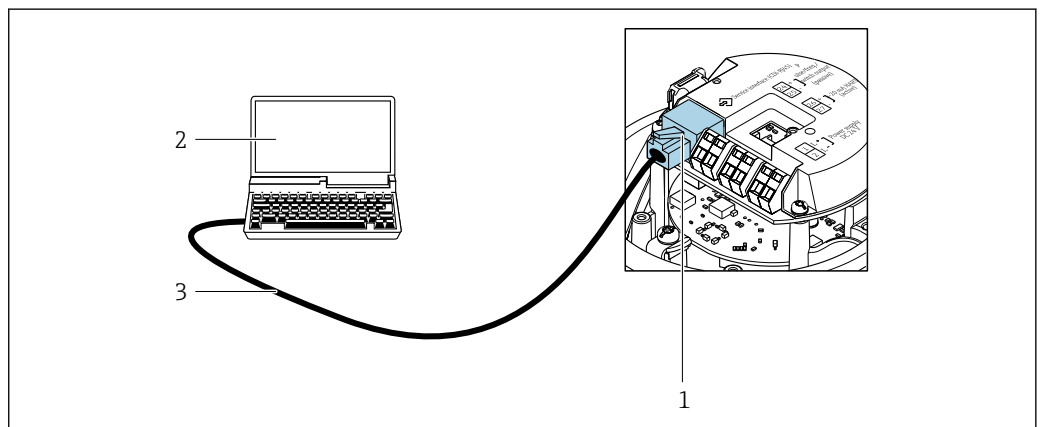

A0016926

56 Connection for the order code for "Output", option B: 4-20 mA HART, pulse/frequency/switch output

- 1 Service interface (CDI-RJ45) of the measuring device with access to the integrated web server
- 2 Computer with web browser (e.g. Internet Explorer) for accessing the integrated web server or with "FieldCare" operating tool with COM DTM "CDI Communication TCP/IP"
- 3 Standard Ethernet connecting cable with RJ45 plug

PROFIBUS DP

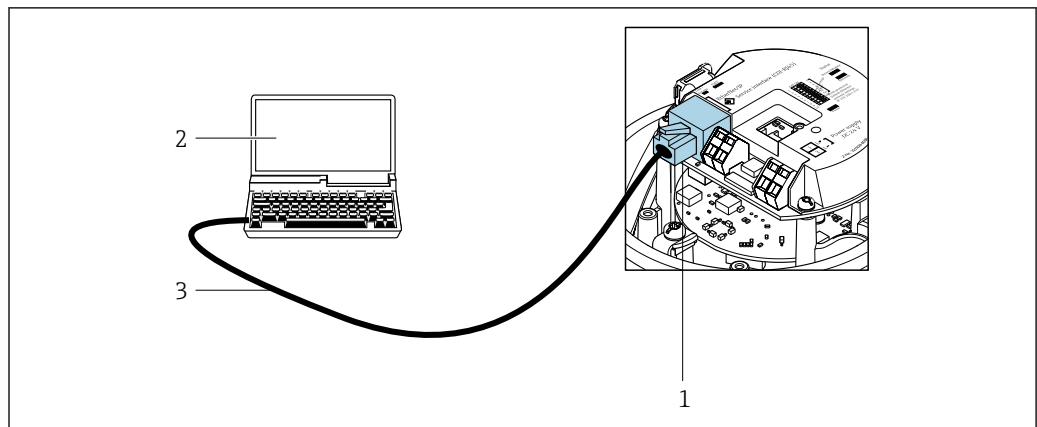

A0021270

57 Connection for order code for "Output", option L: PROFIBUS DP

- 1 Service interface (CDI-RJ45) of the measuring device with access to the integrated web server
- 2 Computer with web browser (e.g. Internet Explorer) for accessing the integrated web server or with "FieldCare" operating tool with COM DTM "CDI Communication TCP/IP"
- 3 Standard Ethernet connecting cable with RJ45 plug

EtherNet/IP

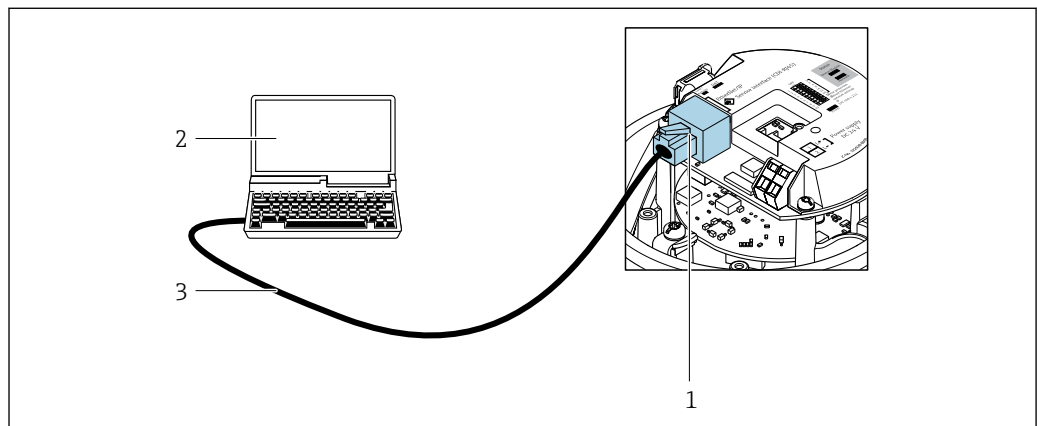

A0016940

58 Connection for order code for "Output", option N: EtherNet/IP

- 1 Service interface (CDI-RJ45) and EtherNet/IP interface of the measuring device with access to the integrated web server
- 2 Computer with web browser (e.g. Internet Explorer) for accessing the integrated web server or with "FieldCare" operating tool with COM DTM "CDI Communication TCP/IP"
- 3 Standard Ethernet connecting cable with RJ45 plug

PROFINET

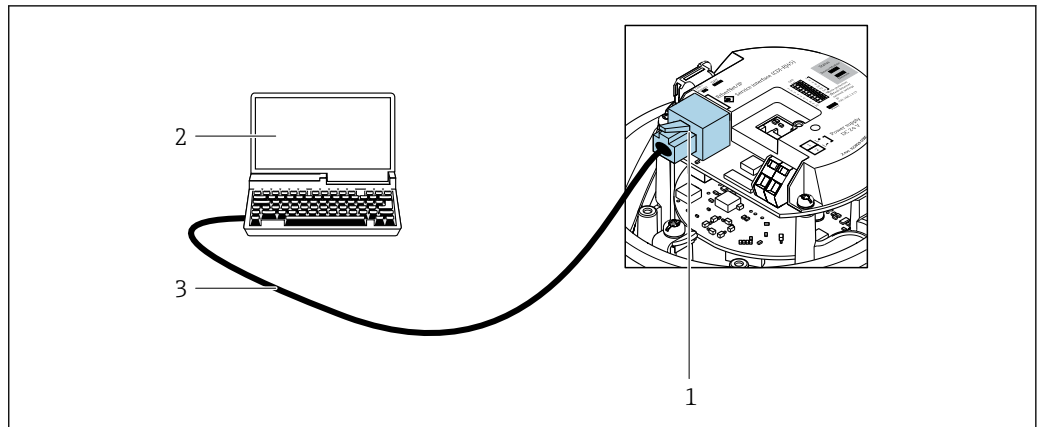

A0016940

59 Connection for order code for "Output", option R: PROFINET

- 1 Service interface (CDI-RJ45) and PROFINET interface of the measuring device with access to the integrated web server
- 2 Computer with web browser (e.g. Internet Explorer) for accessing the integrated web server or with "FieldCare" operating tool with COM DTM "CDI Communication TCP/IP"
- 3 Standard Ethernet connecting cable with RJ45 plug

Via service interface (CDI)

This communication interface is present in the following device version:
Order code for "Output", option **M**: Modbus RS485

Modbus RS485

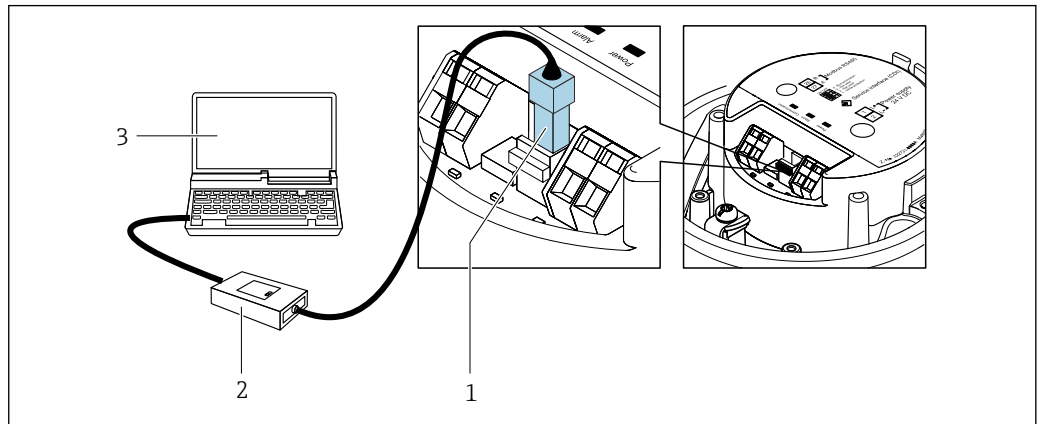

A0030216

- 1 Service interface (CDI) of measuring device
- 2 Commubox FXA291
- 3 Computer with "FieldCare" operating tool with COM DTM "CDI Communication FXA291"

Certificates and approvals

Current certificates and approvals that are available for the product can be selected via the Product Configurator at www.endress.com:

1. Select the product using the filters and search field.
2. Open the product page.
3. Select **Configuration**.

CE mark

The device meets the legal requirements of the applicable EU Directives. These are listed in the corresponding EU Declaration of Conformity along with the standards applied.

Endress+Hauser confirms successful testing of the device by affixing to it the CE mark.

UKCA marking

The device meets the legal requirements of the applicable UK regulations (Statutory Instruments). These are listed in the UKCA Declaration of Conformity along with the designated standards. By selecting the order option for UKCA marking, Endress+Hauser confirms a successful evaluation and testing of the device by affixing the UKCA mark.

Contact address Endress+Hauser UK:

Endress+Hauser Ltd.
Floats Road
Manchester M23 9NF
United Kingdom
www.uk.endress.com

RCM mark

The measuring system meets the EMC requirements of the "Australian Communications and Media Authority (ACMA)".

Pressure Equipment Directive

The devices can be ordered with or without a PED or UKCA approval. If a device with a PED or UKCA approval is required, this must be explicitly stated in the order. For devices with nominal diameters less than or equal to DN 25 (1"), this is neither possible nor necessary. A UK Ex approval must be selected for UKCA.

- With the marking:
 - a) PED/G1/x (x = category) or
 - b) UK/G1/x (x = category)
 on the sensor nameplate, Endress+Hauser confirms compliance with the "Essential Safety Requirements"
 - a) specified in Annex I of the Pressure Equipment Directive 2014/68/EU or
 - b) Schedule 2 of Statutory Instruments 2016 No. 1105.
- Devices bearing this marking (PED or UKCA) are suitable for the following types of medium:
 - Media in Group 1 and 2 with a vapor pressure greater than, or smaller and equal to 0.5 bar (7.3 psi)
 - Unstable gases
- Devices not bearing this marking (without PED or UKCA) are designed and manufactured according to sound engineering practice. They meet the requirements of
 - a) Art. 4 Para. 3 of the Pressure Equipment Directive 2014/68/EU or
 - b) Part 1, Para. 8 of Statutory Instruments 2016 No. 1105.
 The scope of application is indicated
 - a) in diagrams 6 to 9 in Annex II of the Pressure Equipment Directive 2014/68/EU or
 - b) Schedule 3, Para. 2 of Statutory Instruments 2016 No. 1105.

Other standards and guidelines

- EN 60529
Degrees of protection provided by enclosures (IP code)
- IEC/EN 60068-2-6
Environmental influences: Test procedure - Test Fc: vibrate (sinusoidal).
- IEC/EN 60068-2-31
Environmental influences: Test procedure - Test Ec: shocks due to rough handling, primarily for devices.
- EN 61010-1
Safety requirements for electrical equipment for measurement, control and laboratory use - general requirements
- IEC/EN 61326-2-3
Emission in accordance with Class A requirements. Electromagnetic compatibility (EMC requirements).
- NAMUR NE 21
Electromagnetic compatibility (EMC) of industrial process and laboratory control equipment
- NAMUR NE 32
Data retention in the event of a power failure in field and control instruments with microprocessors
- NAMUR NE 43
Standardization of the signal level for the breakdown information of digital transmitters with analog output signal.
- NAMUR NE 53
Software of field devices and signal-processing devices with digital electronics

- NAMUR NE 80
The application of the pressure equipment directive to process control devices
- NAMUR NE 105
Specifications for integrating fieldbus devices in engineering tools for field devices
- NAMUR NE 107
Self-monitoring and diagnosis of field devices
- NAMUR NE 131
Requirements for field devices for standard applications
- NAMUR NE 132
Coriolis mass meter
- ETSI EN 300 328
Guidelines for 2.4 GHz radio components.
- EN 301489
Electromagnetic compatibility and radio spectrum matters (ERM).

Ordering information

Detailed ordering information is available as follows:

- In the Product Configurator on the Endress+Hauser website: www.endress.com -> Click "Corporate" -> Select your country -> Click "Products" -> Select the product using the filters and search field -> Open product page -> The "Configure" button to the right of the product image opens the Product Configurator.
- From your Endress+Hauser Sales Center: www.addresses.endress.com



Product Configurator - the tool for individual product configuration

- Up-to-the-minute configuration data
- Depending on the device: Direct input of measuring point-specific information such as measuring range or operating language
- Automatic verification of exclusion criteria
- Automatic creation of the order code and its breakdown in PDF or Excel output format
- Ability to order directly in the Endress+Hauser Online Shop

Application packages

Many different application packages are available to enhance the functionality of the device. Such packages might be needed to address safety aspects or specific application requirements.

The application packages can be ordered with the device or subsequently from Endress+Hauser.

Detailed information on the order code in question is available from your local Endress+Hauser sales center or on the product page of the Endress+Hauser website: www.endress.com.



Detailed information on the application packages:
Special Documentation for the device → 97

Heartbeat Technology

Order code for "Application package", option EB "Heartbeat Verification + Monitoring"

Heartbeat Verification

Meets the requirement for traceable verification to DIN ISO 9001:2008 Chapter 7.6 a) "Control of monitoring and measuring equipment".

- Functional testing in the installed state without interrupting the process.
- Traceable verification results on request, including a report.
- Simple testing process via local operation or other operating interfaces.
- Clear measuring point assessment (pass/fail) with high test coverage within the framework of manufacturer specifications.
- Extension of calibration intervals according to operator's risk assessment.

Heartbeat Monitoring

Continuously supplies data, which are characteristic of the measuring principle, to an external condition monitoring system for the purpose of preventive maintenance or process analysis. These data enable the operator to:

- Draw conclusions - using these data and other information - about the impact process influences (e.g. corrosion, abrasion, formation of buildup etc.) have on the measuring performance over time.
- Schedule servicing in time.
- Monitor the process or product quality, e.g. gas pockets.

 For detailed information, see the Special Documentation for the device.

Concentration measurement

Order code for "Application package", option ED "Concentration"

Calculation and outputting of fluid concentrations.

The measured density is converted to the concentration of a substance of a binary mixture using the "Concentration" application package:

- Choice of predefined fluids (e.g. various sugar solutions, acids, alkalis, salts, ethanol etc.).
- Common or user-defined units (°Brix, °Plato, % mass, % volume, mol/l etc.) for standard applications.
- Concentration calculation from user-defined tables.

The measured values are output via the digital and analog outputs of the device.

 For detailed information, see the Special Documentation for the device.

Special density

Order code for "Application package", option EE "Special density"

Many applications use density as a key measured value for monitoring quality or controlling processes. The device measures the density of the fluid as standard and makes this value available to the control system.

The "Special Density" application package offers high-precision density measurement over a wide density and temperature range particularly for applications subject to varying process conditions.



 For detailed information, see the Operating Instructions for the device.

Accessories









Various accessories, which can be ordered with the device or subsequently from Endress+Hauser, are available for the device. Detailed information on the order code in question is available from your local Endress+Hauser sales center or on the product page of the Endress+Hauser website: www.endress.com.

Device-specific accessories



For the sensor

Accessories	Description
Heating jacket	<p>Is used to stabilize the temperature of the fluids in the sensor. Water, water vapor and other non-corrosive liquids are permitted for use as fluids.</p> <p> If using oil as a heating medium, please consult with Endress+Hauser.</p> <ul style="list-style-type: none"> ▪ If ordered together with the measuring device: Order code for "Accessory enclosed" <ul style="list-style-type: none"> ▪ Option RB "Heating jacket, G 1/2" female thread" ▪ Option RC "Heating jacket, G 3/4" female thread" ▪ Option RD "Heating jacket, NPT 1/2" female thread" ▪ Option RE "Heating jacket, NPT 3/4" female thread" ▪ If ordered subsequently: Use the order code with the product root DK8003. <p> Special Documentation SD02160D</p>



Communication-specific accessories

Accessories	Description
Commubox FXA195 HART	For intrinsically safe HART communication with FieldCare via the USB interface.  Technical Information TI00404F
Commubox FXA291	Connects Endress+Hauser field devices with a CDI interface (= Endress+Hauser Common Data Interface) and the USB port of a computer or laptop.  Technical Information TI405C/07
HART Loop Converter HMX50	Is used to evaluate and convert dynamic HART process variables to analog current signals or limit values.  <ul style="list-style-type: none"> ▪ Technical Information TI00429F ▪ Operating Instructions BA00371F
Wireless HART adapter SWA70	Is used for the wireless connection of field devices. The WirelessHART adapter can be easily integrated into field devices and existing infrastructures, offers data protection and transmission safety and can be operated in parallel with other wireless networks with minimum cabling complexity.  Operating Instructions BA00061S
Fieldgate FXA42	Is used to transmit the measured values of connected 4 to 20 mA analog measuring devices, as well as digital measuring devices  <ul style="list-style-type: none"> ▪ Technical Information TI01297S ▪ Operating Instructions BA01778S ▪ Product page: www.endress.com/fxa42
Field Xpert SMT50	The Field Xpert SMT70 tablet PC for device configuration enables mobile plant asset management in non-hazardous areas. It is suitable for commissioning and maintenance staff to manage field instruments with a digital communication interface and to record progress. This tablet PC is designed as an all-in-one solution with a preinstalled driver library and is an easy-to-use, touch-sensitive tool which can be used to manage field instruments throughout their entire life cycle.  <ul style="list-style-type: none"> ▪ Technical Information TI01342S ▪ Operating Instructions BA01709S ▪ Product page: www.endress.com/smt50
Field Xpert SMT70	The Field Xpert SMT70 tablet PC for device configuration enables mobile plant asset management in hazardous and non-hazardous areas. It is suitable for commissioning and maintenance staff to manage field instruments with a digital communication interface and to record progress. This tablet PC is designed as an all-in-one solution with a preinstalled driver library and is an easy-to-use, touch-sensitive tool which can be used to manage field instruments throughout their entire life cycle.  <ul style="list-style-type: none"> ▪ Technical Information TI01342S ▪ Operating Instructions BA01709S ▪ Product page: www.endress.com/smt70
Field Xpert SMT77	The Field Xpert SMT77 tablet PC for device configuration enables mobile plant asset management in areas categorized as Ex Zone 1.  <ul style="list-style-type: none"> ▪ Technical Information TI01418S ▪ Operating Instructions BA01923S ▪ Product page: www.endress.com/smt77

Service-specific accessories

Accessory	Description
Applicator	<p>Software for selecting and sizing Endress+Hauser measuring devices:</p> <ul style="list-style-type: none"> Choice of measuring devices with industrial requirements Calculation of all the necessary data for identifying the optimum flowmeter: e.g. nominal diameter, pressure loss, flow velocity and accuracy. Graphic illustration of the calculation results Determination of the partial order code, administration, documentation and access to all project-related data and parameters over the entire life cycle of a project. <p>Applicator is available:</p> <ul style="list-style-type: none"> Via the Internet: https://portal.endress.com/webapp/applicator As a downloadable DVD for local PC installation.
W@M	<p>W@M Life Cycle Management</p> <p>Improved productivity with information at your fingertips. Data relevant to a plant and its components is generated from the first stages of planning and during the asset's complete life cycle.</p> <p>W@M Life Cycle Management is an open and flexible information platform with online and on-site tools. Instant access for your staff to current, in-depth data shortens your plant's engineering time, speeds up procurement processes and increases plant uptime.</p> <p>Combined with the right services, W@M Life Cycle Management boosts productivity in every phase. For more information, see: www.endress.com/lifecyclemanagement</p>
FieldCare	<p>FDT-based plant asset management tool from Endress+Hauser. It can configure all smart field units in your system and helps you manage them. By using the status information, it is also a simple but effective way of checking their status and condition.</p> <p> Operating Instructions BA00027S and BA00059S</p>
DeviceCare	<p>Tool for connecting and configuring Endress+Hauser field devices.</p> <p> Innovation brochure IN01047S</p>

System components

Accessories	Description
Memograph M graphic data manager	<p>The Memograph M graphic data manager provides information on all the relevant measured variables. Measured values are recorded correctly, limit values are monitored and measuring points analyzed. The data are stored in the 256 MB internal memory and also on a SD card or USB stick.</p> <p> <ul style="list-style-type: none"> Technical Information TI00133R Operating Instructions BA00247R </p>
iTEMP	<p>The temperature transmitters can be used in all applications and are suitable for the measurement of gases, steam and liquids. They can be used to read in the medium temperature.</p> <p> "Fields of Activity" document FA00006T</p>

Supplementary documentation

-  For an overview of the scope of the associated Technical Documentation, refer to the following:
- Device Viewer* (www.endress.com/deviceviewer): Enter the serial number from the nameplate
 - Endress+Hauser Operations app*: Enter serial number from nameplate or scan matrix code on nameplate.

Standard documentation **Brief Operating Instructions**

Brief Operating Instructions for the sensor

Measuring device	Documentation code
Proline Promass P	KA01286D

Transmitter Brief Operating Instructions

Measuring device	Documentation code
Proline Promass 100	KA01334D KA01333D KA01335D KA01332D KA01336D

Technical Information

Measuring device	Documentation code
Proline Promass P 100	TI01036D

Description of Device Parameters

Measuring device	Documentation code
Proline Promass 100	GP01033D
Proline Promass 100	GP01034D
Proline Promass 100	GP01035D
Proline Promass 100	GP01036D
Proline Promass 100	GP01037D

Supplementary device-dependent documentation

Safety Instructions

Content	Documentation code
ATEX/IECEX Ex i	XA00159D
ATEX/IECEX Ex nA	XA01029D
cCSAus IS	XA00160D
INMETRO Ex i	XA01219D
INMETRO Ex nA	XA01220D
NEPSI Ex i	XA01249D
NEPSI Ex nA	XA01262D

Special Documentation

Content	Documentation code
Information on the Pressure Equipment Directive	SD00142D
Modbus RS485 Register Information	SD00154D
Concentration measurement	SD01152D
Concentration measurement	SD01503D
Heartbeat Technology	SD01153D

Content	Documentation code
Heartbeat Technology	SD01493D
Web server	SD01820D
Web server	SD01821D
Web server	SD01822D
Web server	SD01823D

Installation Instructions

Contents	Comment
Installation instructions for spare part sets and accessories	Documentation code: specified for each individual accessory → 94.

Registered trademarks

HART®

Registered trademark of the FieldComm Group, Austin, Texas, USA

PROFIBUS®

Registered trademark of the PROFIBUS Nutzerorganisation e.V. (PROFIBUS User Organization), Karlsruhe, Germany

Modbus®

Registered trademark of SCHNEIDER AUTOMATION, INC.

EtherNet/IP™

Trademark of ODVA, Inc.

PROFINET®

Registered trademark of the PROFIBUS Nutzerorganisation e.V. (PROFIBUS User Organization), Karlsruhe, Germany

TRI-CLAMP®

Registered trademark of Ladish & Co., Inc., Kenosha, USA



71597338

www.addresses.endress.com