



## Triangulation sensor (SbR) OQT400-R201-2EP-IO-0,3M-V31



- Medium design with versatile mounting options
- Multi Pixel Technology (MPT) - flexibility and adaptability
- Reduction of device variety - several switch points within one sensor
- Reliable detection of all surfaces, independent of color and structure
- Low sensitivity to target color
- IO-Link interface for service and process data

Measuring sensor with multiple switch points



### Function

The optical sensors in the series are the first devices to offer an end-to-end solution in a medium-sized standard design – from the thru-beam sensor through to the measuring distance sensor. As a result of this design, the sensors are able to perform practically all standard automation tasks.

The entire series enables sensors to communicate via IO-Link.

The DuraBeam laser sensors are durable and can be used in the same way as a standard sensor.

Multi Pixel Technology (MPT) ensures that the standard sensors are flexible and can be adapted to the application environment.

**Dimensions**

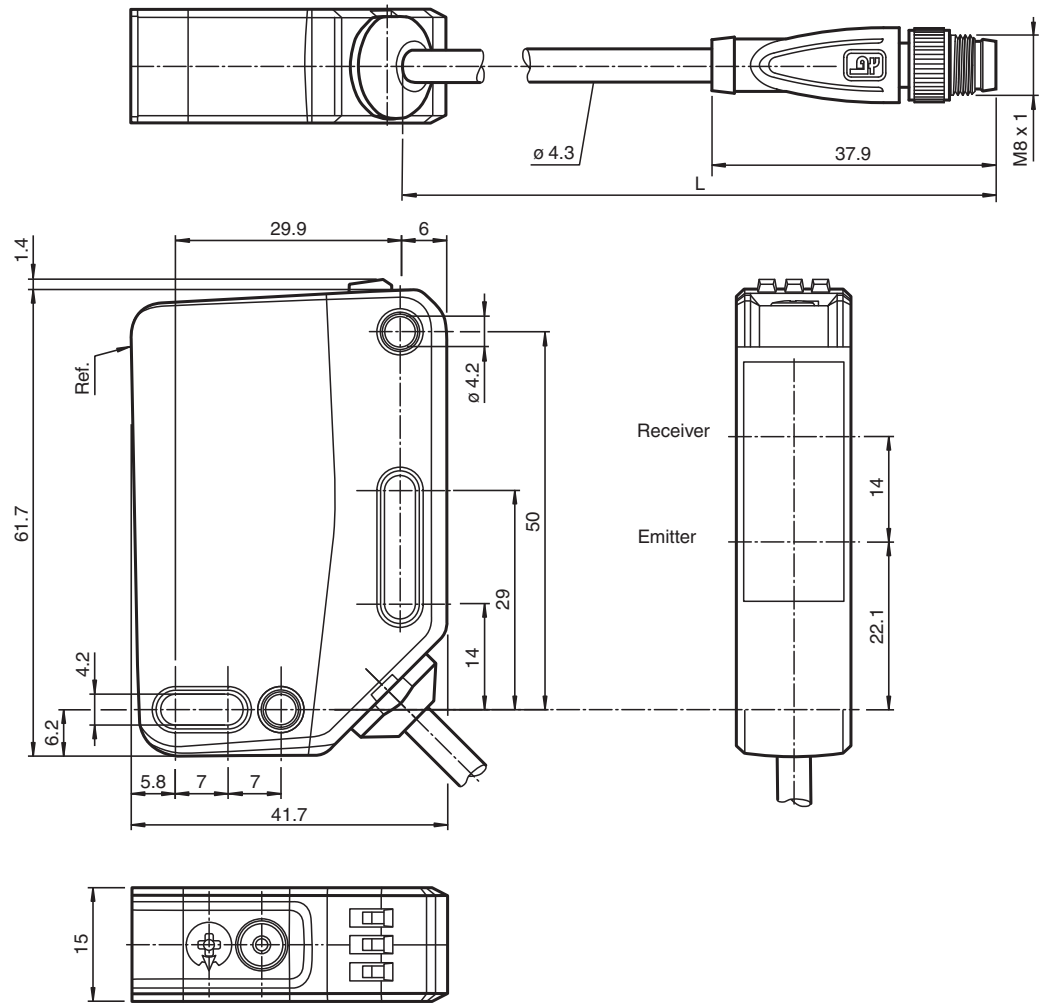

**Technical Data**

General specifications	
Detection range	40 ... 400 mm
Detection range min.	40 ... 100 mm
Detection range max.	40 ... 400 mm
Adjustment range	100 ... 400 mm
Reference target	standard white, 100 mm x 100 mm
Light source	LED
Light type	modulated visible red light
LED risk group labelling	exempt group
Black-white difference (6%/90%)	< 5 %
Diameter of the light spot	approx. 15 mm at a distance of 400 mm
Opening angle	approx. 2.5 °
Ambient light limit	EN 60947-5-2 : 70000 Lux
Functional safety related parameters	
MTTF <sub>d</sub>	600 a
Mission Time (T <sub>M</sub> )	20 a
Diagnostic Coverage (DC)	0 %
Indicators/operating means	
Operation indicator	LED green: constantly on - power on flashing (4Hz) - short circuit flashing with short break (1 Hz) - IO-Link mode

Release date: 2023-01-16 Date of issue: 2023-01-16 Filename: 295670-100168\_eng.pdf

## Technical Data

Function indicator		LED yellow: constantly on - switch output active constantly off - switch output inactive
Control elements		Teach-In key
Control elements		5-step rotary switch for operating modes selection
<b>Electrical specifications</b>		
Operating voltage	$U_B$	10 ... 30 V DC
Ripple		max. 10 %
No-load supply current	$I_0$	< 25 mA at 24 V supply voltage
Protection class		III
<b>Interface</b>		
Interface type		IO-Link ( via C/Q = pin 4 )
IO-Link revision		1.1
Device profile		Identification and diagnosis Smart Sensor type 0
Device ID		0x111811 (1120273)
Transfer rate		COM2 (38.4 kBit/s)
Min. cycle time		2.3 ms
Process data width		Process data input 2 Bit Process data output 2 Bit
SIO mode support		yes
Compatible master port type		A
<b>Output</b>		
Switching type		The default setting is: C/Q - Pin4: NPN normally open, PNP normally closed, IO-Link Q2 - Pin2: NPN normally-open, PNP normally-closed
Signal output		2 push-pull (4 in 1) outputs, short-circuit protected, reverse polarity protected, overvoltage protected
Switching voltage		max. 30 V DC
Switching current		max. 100 mA , resistive load
Usage category		DC-12 and DC-13
Voltage drop	$U_d$	$\leq 1.5$ V DC
Switching frequency	$f$	217 Hz
Response time		2.3 ms
<b>Conformity</b>		
Communication interface		IEC 61131-9
Product standard		EN 60947-5-2
<b>Approvals and certificates</b>		
UL approval		E87056 , cULus Listed , class 2 power supply , type rating 1
CCC approval		CCC approval / marking not required for products rated $\leq 36$ V
<b>Ambient conditions</b>		
Ambient temperature		-40 ... 60 °C (-40 ... 140 °F) , fixed cable -20 ... 60 °C (-4 ... 140 °F) , movable cable not appropriate for conveyor chains
Storage temperature		-40 ... 70 °C (-40 ... 158 °F)
<b>Mechanical specifications</b>		
Housing width		15 mm
Housing height		61.7 mm
Housing depth		41.7 mm
Degree of protection		IP67 / IP69 / IP69K
Connection		fixed cable 300 mm with M8 x 1 male connector; 4-pin
Material		
Housing		PC (Polycarbonate)
Optical face		PMMA
Mass		approx. 51 g
Cable length		0.3 m

Release date: 2023-01-16 Date of issue: 2023-01-16 Filename: 295670-100168\_eng.pdf

**Connection**

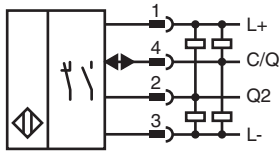

**Connection Assignment**



Wire colors in accordance with EN 60947-5-2

- 1 | BN (brown)
- 2 | WH (white)
- 3 | BU (blue)
- 4 | BK (black)

**Assembly**

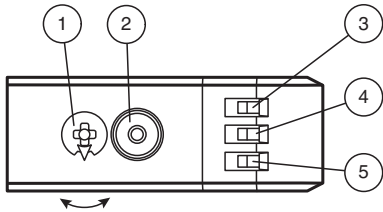

1	Mode rotary switch	
2	Teach-in button	
3	Switching output display Q2	YE
4	Switching output display Q1	YE
5	Operating indicator	GN

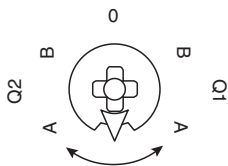

Q1B	Switching output 1/switch point B
Q1A	Switching output 1/switch point A
Q2A	Switching output 2/switch point A
Q2B	Switching output 2/switch point B
0	Keylock

Release date: 2023-01-16 Date of issue: 2023-01-16 Filename: 295670-100168\_eng.pdf

Refer to "General Notes Relating to Pepperl+Fuchs Product Information".

**Characteristic Curve**

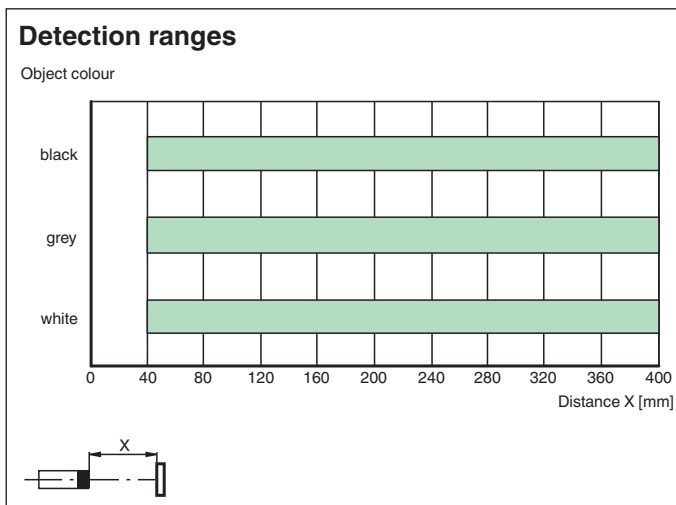
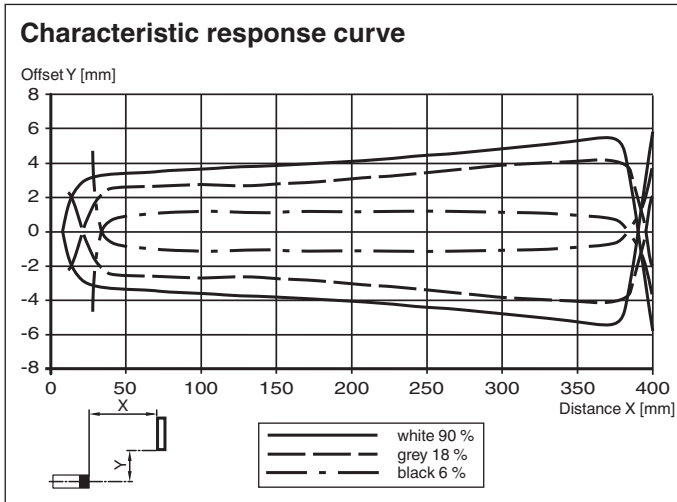









**Accessories**

	<b>OMH-RL31-02</b>	Mounting bracket narrow
	<b>OMH-RL31-03</b>	Mounting bracket narrow
	<b>OMH-RL31-04</b>	Mounting aid for round steel $\varnothing$ 12 mm or sheet 1.5 mm ... 3 mm
	<b>OMH-RL31-07</b>	Mounting bracket including adjustment
	<b>OMH-R20x-Quick-Mount</b>	Quick mounting accessory
	<b>ICE2-8IOL-G65L-V1D</b>	EtherNet/IP IO-Link master with 8 inputs/outputs
	<b>ICE3-8IOL-G65L-V1D</b>	PROFINET IO IO-Link master with 8 inputs/outputs
	<b>ICE2-8IOL-K45S-RJ45</b>	EtherNet/IP IO-Link master with 8 inputs/outputs, DIN rail, screw terminal

Release date: 2023-01-16 Date of issue: 2023-01-16 Filename: 295670-100168\_eng.pdf

**Accessories**

	<b>ICE3-8IOL-K45P-RJ45</b>	PROFINET IO IO-Link master with 8 inputs/outputs, DIN rail, push-in terminals
	<b>ICE3-8IOL-K45S-RJ45</b>	PROFINET IO IO-Link master with 8 inputs/outputs, DIN rail, screw terminal
	<b>IO-Link-Master02-USB</b>	IO-Link master, supply via USB port or separate power supply, LED indicators, M12 plug for sensor connection
	<b>ICE1-8IOL-G30L-V1D</b>	Ethernet IO-Link module with 8 inputs/outputs
	<b>ICE1-8IOL-G60L-V1D</b>	Ethernet IO-Link module with 8 inputs/outputs
	<b>ICE2-8IOL-K45P-RJ45</b>	EtherNet/IP IO-Link master with 8 inputs/outputs, DIN rail, push-in connectors
	<b>V31-GM-2M-PUR</b>	Female cordset single-ended M8 straight A-coded, 4-pin, PUR cable grey
	<b>V31-WM-2M-PUR</b>	Female cordset single-ended M8 angled A-coded, 4-pin, PUR cable grey

Release date: 2023-01-16 Date of issue: 2023-01-16 Filename: 295670-100168\_eng.pdf

Refer to "General Notes Relating to Pepperl+Fuchs Product Information".

Pepperl+Fuchs Group  
www.pepperl-fuchs.com

USA: +1 330 486 0001  
fa-info@us.pepperl-fuchs.com

Germany: +49 621 776 1111  
fa-info@de.pepperl-fuchs.com

Singapore: +65 6779 9091  
fa-info@sg.pepperl-fuchs.com

## Commissioning

### Teach-In (TI)

Use the rotary switch for switching signal **Q1** or **Q2** to select the relevant switching threshold A and/or B to teach in.

- The yellow LEDs indicate the current state of the selected output.

To teach in a switching threshold, press and hold the "TI" button for approximately 1 s, until the yellow and green LEDs flash in phase. Teach-in starts when the "TI" button is released.

- Teach-in successful: the yellow and green LEDs flash alternately at 2.5 Hz.
- Teach-in unsuccessful: the yellow and green LEDs quickly flash alternately at 8 Hz.

After an unsuccessful Teach-in, the sensor continues to operate with the previous valid setting after the relevant visual fault signal is issued.

Set switching mode: you can define different switching modes by teaching in the relevant distance data for switching thresholds A and B.

#### 1. Single point mode:

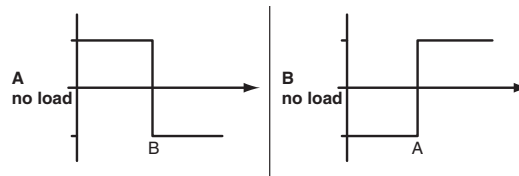

#### 2. Window mode:

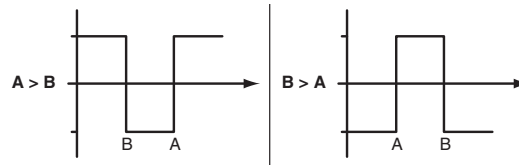

Teach in switching thresholds: you can teach in or overwrite a taught-in switching threshold at any time. To do this, press the "TI" button again.

Reset a value: you can reset a taught-in value. To do this, press the "TI" button for > 4 s, until the yellow and green LEDs go out. The reset process itself starts when the "TI" button is released.

- Reset successful: the yellow and green LEDs flash alternately at 2.5 Hz.

### Resetting to Factory Settings

To revert back to factory settings, press the "TI" button for > 10 s with the rotary switch set to position "O," until the yellow and green LEDs go out at the same time. The reset process itself starts when the "TI" button is released.

- Reset to factory settings successful: the yellow and green LEDs light up at the same time. The sensor then continues to operate with factory settings.

### OQT

- Factory setting for switching signal Q1:  
Switching signal high active, BGS mode (background suppression)
- Factory setting for switching signal Q2:  
Switching signal high active, BGS mode (background suppression)

## Configuration

### Configuring different operating modes via the IO-Link interface

The devices are equipped with an IO-Link interface as standard for diagnostics and parameterization tasks to ensure optimum adjustment of the sensors to the relevant application. Four different operating modes can be set, among other features:

#### Background suppression operating mode (one switch point):

- Detection of objects irrespective of type and color in a defined detection range. Objects in the background are suppressed.



#### Background evaluation operating mode (one switch point):

Release date: 2023-01-16 Date of issue: 2023-01-16 Filename: 295670-100168\_eng.pdf

- Detection of objects irrespective of type and color against a defined background. Reliable detection of objects at close range (detection range  $\geq 0$  mm). The background serves as reference.

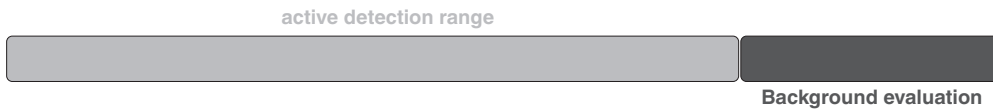

**Single point mode operating mode (one switch point):**

- Detection of objects irrespective of type and color in a defined detection range. Objects in the background are suppressed.
- The switch point corresponds exactly to the set point.



**Window mode operating mode (two switch points):**

- Detection of objects irrespective of type and color in a defined detection range. Reliable detection when object leaves the detection range.
- Window mode with two switch points.



**Center window mode operating mode (one switch point):**

- Detection of objects irrespective of type and color in a defined detection range. Sets a defined window around a given object. Objects outside this window are not detected.
- Window mode with one switch point.



**Two point mode operating mode (hysteresis operating mode):**

- Detection of objects irrespective of type and color between a defined switch-on and switch-off point.

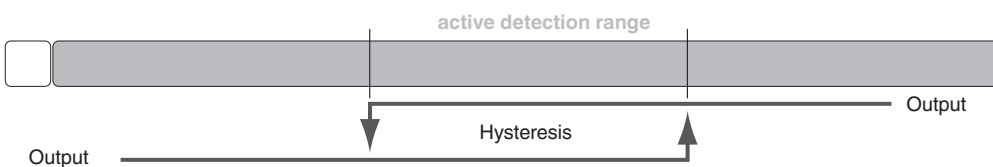

**Inactive operating mode:**

- Evaluation of switching signals is deactivated.

The associated IODD device description file can be found in the download area at [www.pepperl-fuchs.com](http://www.pepperl-fuchs.com).