

Technical Information

Proline Prosonic Flow G 500

Ultrasonic time-of-flight flowmeter



Highly robust gas specialist for fluctuating process conditions as remote version with up to 4 I/Os

Application

- The measuring principle is unaffected by gas composition
- Accurate measurement of natural and process gas in the chemical as well as oil and gas industries

Device properties

- Direct measurement: flow, pressure & temperature
- Wetted parts: titanium / 316L
- Maximum measuring accuracy: 0.5 %
- Remote version with up to 4 I/Os
- Backlit display with touch control and WLAN access
- Standard cable between sensor and transmitter

Your benefits

- Flexible device with user-definable gas mixtures for demanding measuring tasks
- Maximum reliability even with humid or wet gas – sensor design insensitive to condensate
- High-performance process control – real-time pressure- and temperaturecompensated values
- Efficient solution – multivariable, no pressure loss
- Full access to process and diagnostic information – numerous, freely combinable I/Os
- Reduced complexity and variety – freely configurable I/O functionality
- Integrated verification – Heartbeat Technology





Table of contents

About this document	3	Process	42
Symbols	3	Medium temperature range	42
Function and system design	4	Medium pressure range	42
Measuring principle	4	Pressure-temperature ratings	43
Measuring system	6	Rupture disk	44
Equipment architecture	8	Flow limit	44
Safety	8	Pressure loss	44
Input	11	Thermal insulation	44
Measured variable	11	Mechanical construction	46
Measuring range	11	Dimensions in SI units	46
Operable flow range	12	Dimensions in US units	53
Input signal	12	Weight	58
Output	14	Materials	59
Output and input variants	14	Process connections	61
Output signal	16	Human interface	61
Signal on alarm	20	Operating concept	61
Ex connection data	22	Languages	62
Low flow cut off	23	Local operation	62
Galvanic isolation	23	Remote operation	62
Protocol-specific data	23	Service interface	64
Power supply	24	Supported operating tools	65
Terminal assignment	24	HistoROM data management	67
Device plugs available	24	Certificates and approvals	68
Pin assignment, device plug	24	CE mark	68
Supply voltage	25	RCM-tick symbol	68
Power consumption	25	Ex approval	68
Current consumption	25	Functional safety	69
Power supply failure	25	HART certification	69
Electrical connection	26	Pressure Equipment Directive	69
Potential equalization	31	Radio approval	69
terminals	32	Additional certification	70
Cable entries	32	Other standards and guidelines	70
Cable specification	32	Ordering information	71
Performance characteristics	36	Application packages	71
Reference operating conditions	36	Diagnostics functions	71
Maximum measured error	36	Heartbeat Technology	71
Repeatability	37	Advanced gas analysis	72
Influence of ambient temperature	37	Accessories	72
Installation	37	Device-specific accessories	72
Mounting location	37	Communication-specific accessories	73
Orientation	37	Service-specific accessories	74
Inlet and outlet runs	38	System components	74
Mounting the transmitter housing	40	Supplementary documentation	74
Special mounting instructions	40	Standard documentation	74
Environment	41	Device-dependent additional documentation	75
Ambient temperature range	41	Registered trademarks	76
Storage temperature	41		
Degree of protection	42		
Vibration- and shock-resistance	42		
Electromagnetic compatibility (EMC)	42		





About this document

Symbols









Electrical symbols

Symbol	Meaning
	Direct current
	Alternating current
	Direct current and alternating current
	Ground connection A grounded terminal which, as far as the operator is concerned, is grounded via a grounding system.
	Protective Earth (PE) A terminal which must be connected to ground prior to establishing any other connections. The ground terminals are situated inside and outside the device: <ul style="list-style-type: none"> ▪ Inner ground terminal: Connects the protective earth to the mains supply. ▪ Outer ground terminal: Connects the device to the plant grounding system.



Communication symbols

Symbol	Meaning
	Wireless Local Area Network (WLAN) Communication via a wireless, local network.
	LED Light emitting diode is off.
	LED Light emitting diode is on.
	LED Light emitting diode is flashing.

Symbols for certain types of information

Symbol	Meaning
	Permitted Procedures, processes or actions that are permitted.
	Preferred Procedures, processes or actions that are preferred.
	Forbidden Procedures, processes or actions that are forbidden.
	Tip Indicates additional information.
	Reference to documentation.
	Reference to page.
	Reference to graphic.
	Visual inspection.

Symbols in graphics

Symbol	Meaning
1, 2, 3, ...	Item numbers
1., 2., 3., ...	Series of steps
A, B, C, ...	Views
A-A, B-B, C-C, ...	Sections
	Hazardous area
	Safe area (non-hazardous area)
	Flow direction

Function and system design

Measuring principle

The measuring device measures the flow velocity in the measuring tube based on an offset arrangement of ultrasonic sensors downstream. The design does not cause any pressure loss and does not have any moving parts.

The flow signal is established by alternating an acoustic signal between the sensor pairs and measuring the transit time of each transmission. Then utilizing the fact that sound travels faster with the flow versus against the flow, this differential time (ΔT) can be used to determine the fluid's velocity between the sensors.

The volume flow rate is established by combining all the flow velocities determined by the sensor pairs with the cross sectional area of the meter body and extensive knowledge about fluid flow dynamics. The design of the sensors and their position ensures that only a short straight run of pipe upstream of the meter is required after typical flow obstructions such as bends in one or two planes.

Advanced digital signal processing and innovative sensor design facilitate constant flow measurement evaluation and reduce sensitivity to multiphase flow conditions and increase measurement reliability.

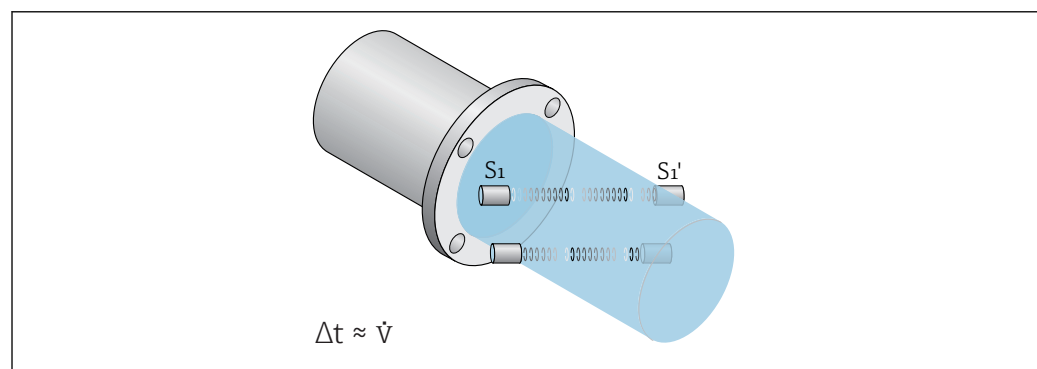

A0015451

Measurement of the gas quality (Advanced gas analysis)

The sound velocity, temperature, pressure, chemical composition and other properties of a gas mixture are dependent on each other. For example, the higher the temperature or the methane fraction, the higher the sound velocity in a natural gas.

As the measuring device accurately measures the sound velocity, gas temperature and gas pressure, the properties of the gas mixture can be calculated directly and displayed on site without the need for an additional measuring instrument. In this way, the measuring device can, for example, determine the density and gross calorific value of a natural gas whose composition is variable or not known.

In the case of gas mixtures that primarily consist of methane, CO₂ and steam (e.g. sewage gas and some types of coal gas), the measuring device enables the direct measurement of the methane fraction and therefore also of the other gas properties.

The measuring device is unique in its ability to measure the gas properties directly, making it possible to monitor the gas flow and gas quality 24/7. This allows plant operators to react swiftly and specifically to problems occurring in the process.

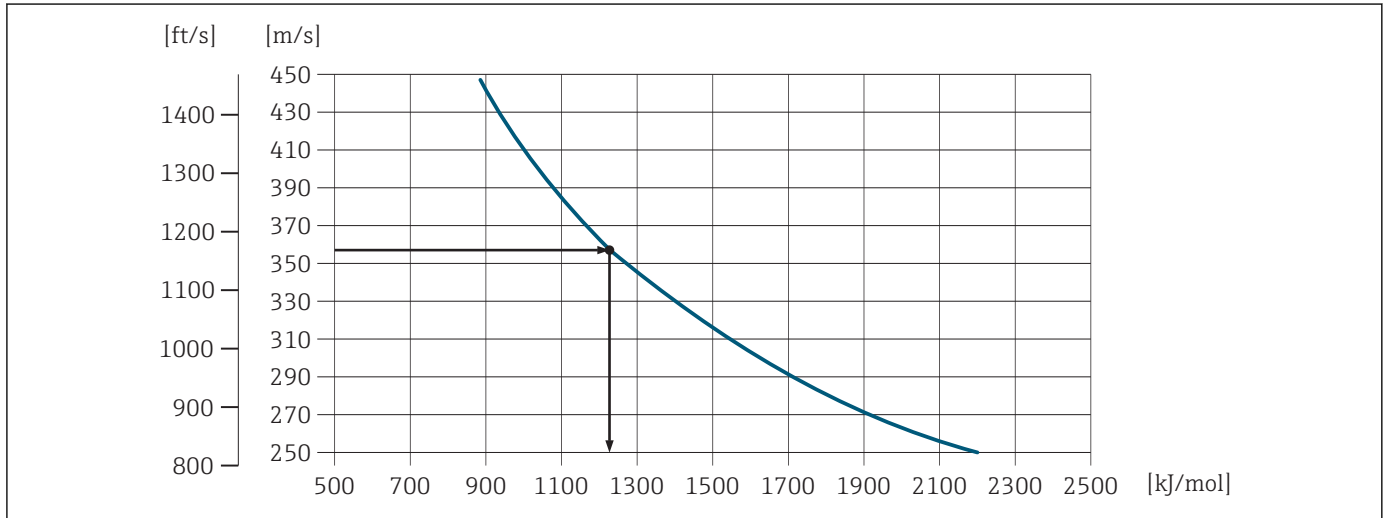

A0037959

1 Calculation of the gross calorific value of a natural gas using the sound velocity at temperature T and pressure p

Measuring system

The measuring system consists of a transmitter and a sensor. The transmitter and sensor are mounted in physically separate locations. They are interconnected by connecting cables.

Proline 500 – digital transmitter

For use in applications not required to meet special requirements due to ambient or operating conditions.

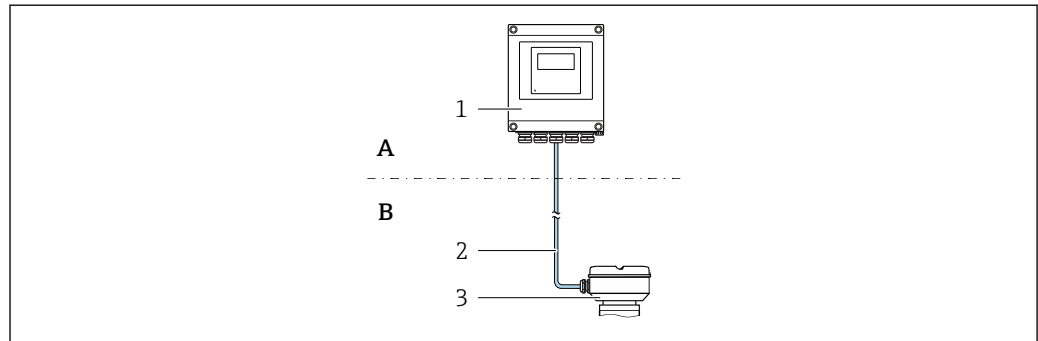

- A Non-hazardous area or Zone 2; Class I, Division 2
 B Non-hazardous area or Zone 2; Class I, Division 2 or Zone 1; Class I, Division 1
 1 Transmitter
 2 Connecting cable: cable, separate, standard
 3 Sensor connection housing with integrated ISEM

- Electronics in the transmitter housing, ISEM (intelligent sensor electronics module) in the sensor connection housing
- Signal transmission: digital
 Order code for "Integrated ISEM electronics", option A "Sensor"

Connecting cable

Connecting cables can be ordered in various lengths → 72.

- Length:
 - Zone 2; Class I, Division 2: max. 300 m (1 000 ft)
 - Zone 1; Class I, Division 1: max. 150 m (500 ft)
- Standard cable with common shield (pair-stranded)
- Not sensitive to external EMC interference.

Hazardous area

Use in: Zone 2; Class I, Division 2

Mixed installation is possible:

- Sensor: Zone 1; Class I, Division 1
- Transmitter: Zone 2; Class I, Division 2

Device versions and materials

- Transmitter housing
 - Aluminum, coated: aluminum, AlSi10Mg, coated
 - Material: polycarbonate
- Material of window in transmitter housing
 - Aluminum, coated: glass
 - Polycarbonate: plastic

Configuration

- External operation via 4-line, backlit, graphic local display with touch control and guided menus ("Make-it-run" wizards) for application-specific commissioning.
- Via service interface or WLAN connection:
 - Operating tools (e.g. FieldCare, DeviceCare)
 - Web server (access via Web browser, e.g. Microsoft Internet Explorer, Microsoft Edge)

Sensor connection housing

Different versions of the connection housing are available.

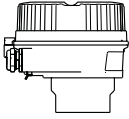
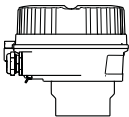
	Order code for "Sensor connection housing", option A, "Aluminum, coated": Aluminum, AlSi10Mg, coated
	Order code for "Sensor connection housing", option L, "Cast, stainless": 1.4409 (CF3M) similar to 316L

Sensor

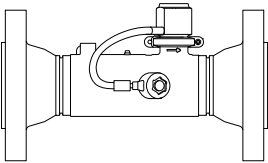
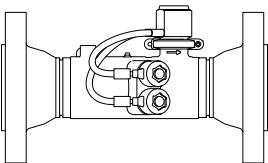
<p>Prosonic Flow G</p> <p><i>Single-path version: DN 25 (1")</i></p>  <p style="text-align: right; font-size: small;">A0037526</p>	<ul style="list-style-type: none"> ■ Measurement of: <ul style="list-style-type: none"> ■ Process gases and gas mixtures ■ Natural gases ■ Coal gases ■ Shale gases ■ Biogases/sewage gases ■ Nominal diameter range: DN 25 to 300 (1 to 12") ■ Materials: <ul style="list-style-type: none"> ■ Measuring tube: <ul style="list-style-type: none"> Stainless steel: 1.4408/1.4409 (CF3M) ■ Welding neck flanges: <ul style="list-style-type: none"> Stainless steel: 1.4404 (316, 316L) ■ Ultrasonic transducer: <ul style="list-style-type: none"> Stainless steel: 1.4404 (316, 316L) Grade 2 titanium ■ Seal for ultrasonic transducer: <ul style="list-style-type: none"> FKM material group
<p><i>Two-path version: DN 50 to 300 (2 to 12")</i></p>  <p style="text-align: right; font-size: small;">A0037527</p>	

Pressure measuring cell and temperature sensor

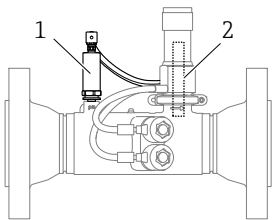
 <p style="text-align: right; font-size: small;">A0037496</p> <p>1 Pressure measuring cell 2 Temperature sensor</p>	<p>Versions:</p> <ul style="list-style-type: none"> ■ Pressure components <ul style="list-style-type: none"> ■ Pressure measuring cell 2 bar (29 psi) absolute ■ Pressure measuring cell 4 bar (58 psi) absolute ■ Pressure measuring cell 10 bar (145 psi) absolute ■ Pressure measuring cell 40 bar (580 psi) absolute ■ Pressure measuring cell 100 bar (1450 psi) absolute ■ Temperature sensor <ul style="list-style-type: none"> Covers the entire measuring range without variance <p>Material</p> <ul style="list-style-type: none"> ■ Wetted parts: <ul style="list-style-type: none"> ■ Membrane: stainless steel, 1.4435 (316L) ■ Process connection: stainless steel, 1.4404 (316, 316L) ■ Temperature sensor: stainless steel, 1.4404 (316, 316L) ■ Non-wetted parts: <ul style="list-style-type: none"> Housing: stainless steel, 1.4404 (316, 316L)
--	--

Equipment architecture

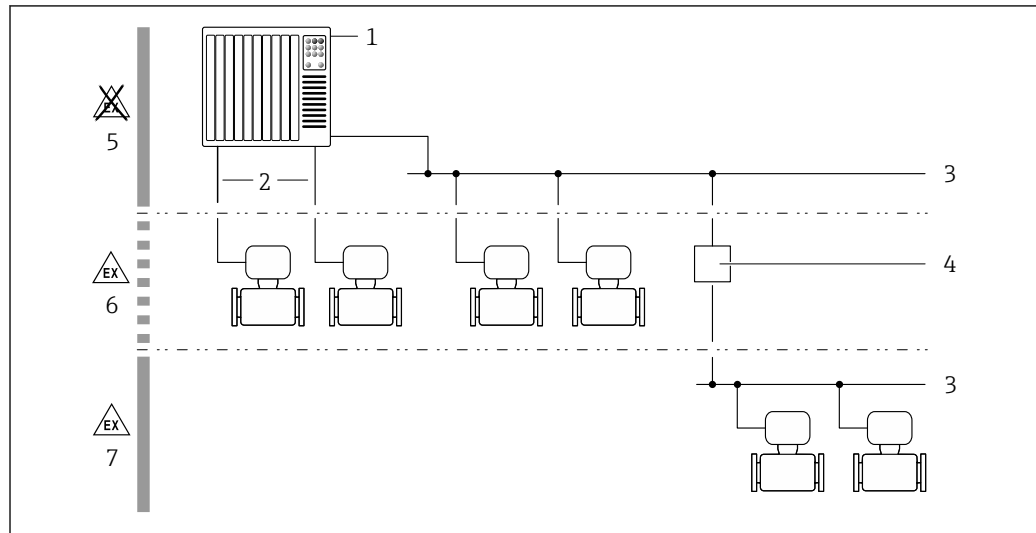

A0027512

2 Possibilities for integrating measuring devices into a system

- 1 Control system (e.g. PLC)
- 2 Connecting cable (0/4 to 20 mA HART etc.)
- 3 Fieldbus
- 4 Segment coupler
- 5 Non-hazardous area
- 6 Hazardous area: Zone 2; Class I, Division 2
- 7 Hazardous area: Zone 1; Class I, Division 1

Safety

IT security

Our warranty is valid only if the device is installed and used as described in the Operating Instructions. The device is equipped with security mechanisms to protect it against any inadvertent changes to the settings.

IT security measures, which provide additional protection for the device and associated data transfer, must be implemented by the operators themselves in line with their security standards.

Device-specific IT security

The device offers a range of specific functions to support protective measures on the operator's side. These functions can be configured by the user and guarantee greater in-operation safety if used correctly. An overview of the most important functions is provided in the following section.

Function/interface	Factory setting	Recommendation
Write protection via hardware write protection switch → 9	Not enabled.	On an individual basis following risk assessment.
Access code (also applies for Web server login or FieldCare connection) → 9	Not enabled (0000).	Assign a customized access code during commissioning.
WLAN (order option in display module)	Enabled.	On an individual basis following risk assessment.
WLAN security mode	Enabled (WPA2-PSK)	Do not change.
WLAN passphrase (password) → 9	Serial number	Assign an individual WLAN passphrase during commissioning.
WLAN mode	Access Point	On an individual basis following risk assessment.
Web server → 9	Enabled.	On an individual basis following risk assessment.
CDI-RJ45 service interface → 9	–	On an individual basis following risk assessment.

Protecting access via hardware write protection

Write access to the device parameters via the local display, Web browser or operating tool (e.g. FieldCare, DeviceCare) can be disabled via a write protection switch (DIP switch on the motherboard). When hardware write protection is enabled, only read access to the parameters is possible.

Hardware write protection is disabled when the device is delivered.

Protecting access via a password

Different passwords are available to protect write access to the device parameters or access to the device via the WLAN interface.

- **User-specific access code**
Protect write access to the device parameters via the local display, Web browser or operating tool (e.g. FieldCare, DeviceCare). Access authorization is clearly regulated through the use of a user-specific access code.
- **WLAN passphrase**
The network key protects a connection between an operating unit (e.g. notebook or tablet) and the device via the WLAN interface which can be ordered as an option.
- **Infrastructure mode**
When the device is operated in infrastructure mode, the WLAN passphrase corresponds to the WLAN passphrase configured on the operator side.

User-specific access code

Write access to the device parameters via the local display, Web browser or operating tool (e.g. FieldCare, DeviceCare) can be protected by the modifiable, user-specific access code.

WLAN passphrase: Operation as WLAN access point

A connection between an operating unit (e.g. notebook or tablet) and the device via the WLAN interface, which can be ordered as an optional extra, is protected by the network key. The WLAN authentication of the network key complies with the IEEE 802.11 standard.

When the device is delivered, the network key is pre-defined depending on the device. It can be changed via the **WLAN settings** submenu in the **WLAN passphrase** parameter.

Infrastructure mode

A connection between the device and WLAN access point is protected by means of an SSID and passphrase on the system side. Please contact the relevant system administrator for access.

General notes on the use of passwords

- The access code and network key supplied with the device should be changed during commissioning.
- Follow the general rules for generating a secure password when defining and managing the access code or network key.
- The user is responsible for the management and careful handling of the access code and network key.

Access via Web server

The device can be operated and configured via a Web browser with the integrated Web server. The connection is via the service interface (CDI-RJ45) or the WLAN interface.

The Web server is enabled when the device is delivered. The Web server can be disabled if necessary (e.g. after commissioning) via the **Web server functionality** parameter.

The device and status information can be hidden on the login page. This prevents unauthorized access to the information.



For detailed information on device parameters, see:
The "Description of Device Parameters" document

Access via service interface (CDI-RJ45)

The device can be connected to a network via the service interface (CDI-RJ45). Device-specific functions guarantee the secure operation of the device in a network.

The use of relevant industrial standards and guidelines that have been defined by national and international safety committees, such as IEC/ISA62443 or the IEEE, is recommended. This includes organizational security measures such as the assignment of access authorization as well as technical measures such as network segmentation.

Input

Measured variable

Direct measured variables

- Flow velocity
- Sound velocity
- Process temperature (optional): based on the measured resistance of a platinum measuring resistor
- Process temperature (optional): based on the measured output voltage of a Wheatstone bridge, which is sensitive to strain

Calculated measured variables

- Volume flow (operation)
- Corrected volume flow (corrected/standard volume flow)
- Mass flow

Optional measured variables (can be ordered)

Order code for "Application package", option EF "Advanced gas analysis"

- Single gas
- Gas mixture
- Coal gas/biogas
- Natural gas – standardized calculation
- Natural gas – using sound velocity

 The measured variables (gas properties) that are available for order depend on the gas type.

Measuring range

$v = 0.3$ to 40 m/s (0.98 to 131.2 ft/s) with the specified accuracy



Flow characteristic values in SI units

Nominal diameter		Recommended flow	Factory settings		
			Full scale value current output	Pulse Value	Low flow cut off (v ~ 0.1 m/s)
[mm]	[in]	[m ³ /h]	[m ³ /h]	[m ³ /pulse]	[m ³ /h]
25	1	0.50 to 67	50	0.007	0.17
50	2	2.05 to 274	210	0.03	0.68
80	3	4.60 to 614	460	0.06	1.5
100	4	8 to 1064	800	0.1	2.7
150	6	18.1 to 2414	1800	0.3	6.0
200	8	32 to 4235	3200	0.4	11
250	10	50 to 6662	5000	0.7	17
300	12	71 to 9426	7100	1.0	24



Flow characteristic values in US units

Nominal diameter		Recommended flow	Factory settings		
			Full scale value current output	Pulse Value	Low flow cut off (v ~ 0.1 m/s)
[in]	[mm]	[ft ³ /hr]	[ft ³ /hr]	[ft ³ /pulse]	[ft ³ /hr]
1	25	17.7 to 2358	1800	0.2	5.9
2	50	73 to 9668	7300	1	24
3	80	163 to 21694	16000	2	54
4	100	282 to 37579	28000	4	94
6	150	639 to 85253	64000	9	213

Nominal diameter		Recommended flow	Factory settings		
			Full scale value current output	Pulse Value	Low flow cut off (v ~ 0.1 m/s)
[in]	[mm]	[ft ³ /hr]	[ft ³ /hr]	[ft ³ /pulse]	[ft ³ /hr]
8	200	1 122 to 149 544	110 000	16	374
10	250	1 764 to 235 259	180 000	25	588
12	300	2 497 to 332 890	250 000	35	832

 To calculate the measuring range, use the *Applicator* sizing tool →  74

Recommended measuring range

 Flow limit →  44

Operable flow range 133 : 1

Input signal

Input and output versions

External measured values

To increase the accuracy of certain measured variables or to calculate the corrected volume flow for gases, the use of the integrated pressure and temperature measurement function is recommended:

- Temperature measurement to increase accuracy (order code for "Measuring tube; transducer; sensor version", option AB "316L; titanium gr. 2; integrated temperature measurement")
- Temperature and pressure measurement to increase accuracy (order code for "Measuring tube; transducer; sensor version", option AC "316L; titanium gr. 2; integrated pressure + temperature measurement")

The measuring device provides optional interfaces that enable the transmission of externally measured variables (temperature, pressure, gas composition ¹⁾) into the measuring device:

- Analog inputs 4-20 mA
- Digital inputs (via HART input or Modbus)

Pressure values can be transmitted as absolute or gauge pressure. For gauge pressure, the atmospheric pressure must be known or specified by the customer.

 Various pressure transmitters and temperature measuring devices can be ordered from Endress +Hauser: see "Accessories" section →  74

HART protocol

The measured values are written from the automation system to the measuring device via the HART protocol. The pressure transmitter must support the following protocol-specific functions:

- HART protocol
- Burst mode

Current input

The measured values are written from the automation system to the measuring device via the current input →  13.

Digital communication

The measured values can be written from the automation system to the measuring via: Modbus RS485

1) The gas composition can be transmitted only using Modbus.

Current input 0/4 to 20 mA

Current input	0/4 to 20 mA (active/passive)
Current span	<ul style="list-style-type: none"> ▪ 4 to 20 mA (active) ▪ 0/4 to 20 mA (passive)
Resolution	1 μ A
Voltage drop	Typically: 0.6 to 2 V for 3.6 to 22 mA (passive)
Maximum input voltage	\leq 30 V (passive)
Open-circuit voltage	\leq 28.8 V (active)
Possible input variables	<ul style="list-style-type: none"> ▪ Pressure ▪ Temperature

Status input

Maximum input values	<ul style="list-style-type: none"> ▪ DC -3 to 30 V ▪ If status input is active (ON): $R_i > 3 \text{ k}\Omega$
Response time	Adjustable: 5 to 200 ms
Input signal level	<ul style="list-style-type: none"> ▪ Low signal: DC -3 to +5 V ▪ High signal: DC 12 to 30 V
Assignable functions	<ul style="list-style-type: none"> ▪ Off ▪ Reset the individual totalizers separately ▪ Reset all totalizers ▪ Flow override

Output

Output and input variants

Depending on the option selected for output/input 1, different options are available for the other outputs and inputs. Only one option can be selected for each output/input 1 to 4. The following tables must be read vertically (↓).

Example: If the option BA "4–20 mA HART" was selected for output/input 1, one of the options A, B, D, E, F, H, I or J is available for output 2, and one of the options A, B, D, E, F, H, I or J is available for output 3 and 4.

Output/input 1 and options for output/input 2





Options for output/input 3 and 4 → 15

Order code for "Output; input 1" (020) →	Possible options	
Current output 4 to 20 mA HART	BA	
Modbus RS485		MA
Order code for "Output; input 2" (021) →	↓	↓
Not assigned	A	A
Current output 4 to 20 mA	B	B
User-configurable input/output ¹⁾	D	D
Pulse/frequency/switch output	E	E
Double pulse output ²⁾	F	F
Relay output	H	H
Current input 0/4 to 20 mA	I	I
Status input	J	J

1) A specific input or output can be assigned to a user-configurable input/output → 20.

2) If double pulse output (F) is selected for output/input 2 (021), only the double pulse output (F) option is available for selection for output/input 3 (022).

Output/input 1 and options for output/input 3 and 4

 Options for output/input 2 →  14

Order code for "Output; input 1" (020) →	Possible options	
Current output 4 to 20 mA HART	BA	
Modbus RS485		MA
Order code for "Output; input 3" (022), "Output; input 4" (023) →	↓	↓
Not assigned	A	A
Current output 4 to 20 mA	B	B
User-configurable input/output	D	D
Pulse/frequency/switch output	E	E
Double pulse output (slave) ¹⁾	F	F
Relay output	H	H
Current input 0/4 to 20 mA	I	I
Status input	J	J

1) The double pulse output (F) option is not available for input/output 4.

Output signal

Current output 4 to 20 mA HART

Order code	"Output; Input 1" (20): Option BA: current output 4 to 20 mA HART
Signal mode	Can be set to: <ul style="list-style-type: none"> ■ Active ■ Passive
Current range	Can be set to: <ul style="list-style-type: none"> ■ 4 to 20 mA NAMUR ■ 4 to 20 mA US ■ 4 to 20 mA ■ 0 to 20 mA (only with signal mode active) ■ Fixed current value
Open-circuit voltage	DC 28.8 V (active)
Maximum input voltage	DC 30 V (passive)
Load	250 to 700 Ω
Resolution	0.38 μ A
Damping	Configurable: 0 to 999 s
Assignable measured variables	<ul style="list-style-type: none"> ■ Volume flow ■ Corrected volume flow ■ Mass flow ■ Energy flow ■ Sound velocity ■ Flow velocity ■ Electronics temperature ■ Methane fraction ¹⁾ ■ Molar mass ■ Density ■ Dynamic viscosity ■ Calorific value ■ Wobbe index ■ Pressure ²⁾ ■ Temperature ³⁾ <p> The range of options increases if the measuring device has one or more application packages.</p>

- 1) Only for the order code for "Application package", option EF "Advanced gas analysis" and with the appropriate configuration
- 2) Only for the order code for "Measuring tube; Transducer; Sensor version", option AC "316L; titanium gr. 2; pressure + temperature measurement integrated"
- 3) Only for the order code for "Measuring tube; Transducer; Sensor version", option AB "316L; titanium gr. 2; temperature measurement integrated" or AC "316L; titanium gr. 2; pressure + temperature measurement integrated"

Modbus RS485

Physical interface	RS485 in accordance with EIA/TIA-485 standard
Terminating resistor	Integrated, can be activated via DIP switches

Current output 4 to 20 mA

Order code	"Output; Input 2" (21), "Output; Input 3" (022) or "Output; Input 4" (023): Option B: current output 4 to 20 mA
Signal mode	Can be set to: <ul style="list-style-type: none"> ■ Active ■ Passive

Current range	Can be set to: <ul style="list-style-type: none"> ■ 4 to 20 mA NAMUR ■ 4 to 20 mA US ■ 4 to 20 mA ■ 0 to 20 mA (only with signal mode active) ■ Fixed current value
Maximum output values	22.5 mA
Open-circuit voltage	DC 28.8 V (active)
Maximum input voltage	DC 30 V (passive)
Load	0 to 700 Ω
Resolution	0.38 μA
Damping	Configurable: 0 to 999 s
Assignable measured variables	<ul style="list-style-type: none"> ■ Volume flow ■ Corrected volume flow ■ Mass flow ■ Energy flow ■ Sound velocity ■ Flow velocity ■ Electronics temperature ■ Methane fraction ¹⁾ ■ Molar mass ■ Density ■ Dynamic viscosity ■ Calorific value ■ Wobbe index ■ Pressure ²⁾ ■ Temperature ³⁾ <p> The range of options increases if the measuring device has one or more application packages.</p>

- 1) Only for the order code for "Application package", option EF "Advanced gas analysis" and with the appropriate configuration
- 2) Only for the order code for "Measuring tube; Transducer; Sensor version", option AC "316L; titanium gr. 2; pressure + temperature measurement integrated"
- 3) Only for the order code for "Measuring tube; Transducer; Sensor version", option AB "316L; titanium gr. 2; temperature measurement integrated" or AC "316L; titanium gr. 2; pressure + temperature measurement integrated"

Pulse/frequency/switch output

Function	Can be set to pulse, frequency or switch output
Version	Open collector Can be set to: <ul style="list-style-type: none"> ■ Active ■ Passive
Maximum input values	DC 30 V, 250 mA (passive)
Open-circuit voltage	DC 28.8 V (active)
Voltage drop	For 22.5 mA: ≤ DC 2 V
Pulse output	
Maximum input values	DC 30 V, 250 mA (passive)
Maximum output current	22.5 mA (active)
Open-circuit voltage	DC 28.8 V (active)
Pulse width	Configurable: 0.05 to 2 000 ms
Maximum pulse rate	10 000 Impulse/s
Pulse value	Adjustable

Assignable measured variables	<ul style="list-style-type: none"> ▪ Volume flow ▪ Corrected volume flow ▪ Mass flow ▪ Energy flow
Frequency output	
Maximum input values	DC 30 V, 250 mA (passive)
Maximum output current	22.5 mA (active)
Open-circuit voltage	DC 28.8 V (active)
Output frequency	Adjustable: end value frequency 2 to 10 000 Hz ($f_{\max} = 12\,500$ Hz)
Damping	Configurable: 0 to 999 s
Pulse/pause ratio	1:1
Assignable measured variables	<ul style="list-style-type: none"> ▪ Volume flow ▪ Corrected volume flow ▪ Mass flow ▪ Energy flow ▪ Sound velocity ▪ Flow velocity ▪ Electronics temperature ▪ Methane fraction ¹⁾ ▪ Molar mass ▪ Density ▪ Dynamic viscosity ▪ Calorific value ▪ Wobbe index ▪ Pressure ²⁾ ▪ Temperature ³⁾ <p> The range of options increases if the measuring device has one or more application packages.</p>
Switch output	
Maximum input values	DC 30 V, 250 mA (passive)
Open-circuit voltage	DC 28.8 V (active)
Switching behavior	Binary, conductive or non-conductive
Switching delay	Configurable: 0 to 100 s

Number of switching cycles	Unlimited
Assignable functions	<ul style="list-style-type: none"> ▪ Off ▪ On ▪ Diagnostic behavior ▪ Limit value <ul style="list-style-type: none"> ▪ Volume flow ▪ Corrected volume flow ▪ Mass flow ▪ Energy flow ▪ Flow velocity ▪ Electronics temperature ▪ Sound velocity ▪ Methane fraction ▪ Molar mass ▪ Density ▪ Dynamic viscosity ▪ Calorific value ▪ Wobbe index ▪ Pressure ▪ Temperature ▪ Totalizer 1-3 ▪ Flow direction monitoring ▪ Status <ul style="list-style-type: none"> Low flow cut off <p> The range of options increases if the measuring device has one or more application packages.</p>

- 1) Only for the order code for "Application package", option EF "Advanced gas analysis" and with the appropriate configuration
- 2) Only for the order code for "Measuring tube; Transducer; Sensor version", option AC "316L; titanium gr. 2; pressure + temperature measurement integrated"
- 3) Only for the order code for "Measuring tube; Transducer; Sensor version", option AB "316L; titanium gr. 2; temperature measurement integrated" or AC "316L; titanium gr. 2; pressure + temperature measurement integrated"

Double pulse output

Function	Double pulse
Version	Open collector Can be set to: <ul style="list-style-type: none"> ▪ Active ▪ Passive ▪ Passive NAMUR
Maximum input values	DC 30 V, 250 mA (passive)
Open-circuit voltage	DC 28.8 V (active)
Voltage drop	For 22.5 mA: ≤ DC 2 V
Output frequency	Configurable: 0 to 1 000 Hz
Damping	Configurable: 0 to 999 s
Pulse/pause ratio	1:1
Assignable measured variables	<ul style="list-style-type: none"> ▪ Volume flow ▪ Corrected volume flow ▪ Mass flow ▪ Energy flow <p> The range of options increases if the measuring device has one or more application packages.</p>

Relay output

Function	Switch output
Version	Relay output, galvanically isolated
Switching behavior	Can be set to: <ul style="list-style-type: none"> ▪ NO (normally open), factory setting ▪ NC (normally closed)
Maximum switching capacity (passive)	<ul style="list-style-type: none"> ▪ DC 30 V, 0.1 A ▪ AC 30 V, 0.5 A
Assignable functions	<ul style="list-style-type: none"> ▪ Off ▪ On ▪ Diagnostic behavior ▪ Limit value <ul style="list-style-type: none"> ▪ Volume flow ▪ Corrected volume flow ▪ Mass flow ▪ Energy flow ▪ Flow velocity ▪ Electronic temperature ▪ Sound velocity ▪ Methane fraction ¹⁾ ▪ Molar mass ¹⁾ ▪ Density ¹⁾ ▪ Dynamic viscosity ¹⁾ ▪ Calorific value ¹⁾ ▪ Wobbe index ¹⁾ ▪ Pressure ²⁾ ▪ Temperature ³⁾ ▪ Totalizer 1-3 ▪ Flow direction monitoring ▪ Status <ul style="list-style-type: none"> Low flow cut off <p> The range of options increases if the measuring device has one or more application packages.</p>

- 1) Only for the order code for "Application package", option EF "Advanced gas analysis" and with the appropriate configuration
- 2) Only for the order code for "Measuring tube; Transducer; Sensor version", option AC "316L; titanium gr. 2; pressure + temperature measurement integrated"
- 3) Only for the order code for "Measuring tube; Transducer; Sensor version", option AB "316L; titanium gr. 2; temperature measurement integrated" or AC "316L; titanium gr. 2; pressure + temperature measurement integrated"

User-configurable input/output

One specific input or output is assigned to a user-configurable input/output (configurable I/O) during device commissioning.

The following inputs and outputs are available for assignment:

- Choice of current output: 4 to 20 mA (active), 0/4 to 20 mA (passive)
- Pulse/frequency/switch output
- Choice of current input: 4 to 20 mA (active), 0/4 to 20 mA (passive)
- Status input

The technical values correspond to those of the inputs and outputs described in this section.

Signal on alarm

Depending on the interface, failure information is displayed as follows:

HART current output

Device diagnostics	Device condition can be read out via HART Command 48
---------------------------	--

Modbus RS485

Failure mode	Choose from: <ul style="list-style-type: none"> ▪ NaN value instead of current value ▪ Last valid value
---------------------	---

Current output 0/4 to 20 mA

4 to 20 mA

Failure mode	Choose from: <ul style="list-style-type: none"> ▪ 4 to 20 mA in accordance with NAMUR recommendation NE 43 ▪ 4 to 20 mA in accordance with US ▪ Min. value: 3.59 mA ▪ Max. value: 22.5 mA ▪ Freely definable value between: 3.59 to 22.5 mA ▪ Actual value ▪ Last valid value
---------------------	--

0 to 20 mA

Failure mode	Choose from: <ul style="list-style-type: none"> ▪ Maximum alarm: 22 mA ▪ Freely definable value between: 0 to 20.5 mA
---------------------	---

Pulse/frequency/switch output

Pulse output	
Failure mode	Choose from: <ul style="list-style-type: none"> ▪ Actual value ▪ No pulses
Frequency output	
Failure mode	Choose from: <ul style="list-style-type: none"> ▪ Actual value ▪ 0 Hz ▪ Defined value ($f_{max} \geq 2$ to 12 500 Hz)
Switch output	
Failure mode	Choose from: <ul style="list-style-type: none"> ▪ Current status ▪ Open ▪ Closed

Relay output

Failure mode	Choose from: <ul style="list-style-type: none"> ▪ Current status ▪ Open ▪ Closed
---------------------	---

Local display



Plain text display	With information on cause and remedial measures
Backlight	Red backlighting indicates a device error.

 Status signal as per NAMUR recommendation NE 107

Interface/protocol

- Via digital communication:
 - HART protocol
 - Modbus RS485
- Via service interface
 - CDI-RJ45 service interface
 - WLAN interface

Plain text display	With information on cause and remedial measures
--------------------	---

 Additional information on remote operation →  62

Web browser

Plain text display	With information on cause and remedial measures
--------------------	---

Light emitting diodes (LED)

Status information	Status indicated by various light emitting diodes The following information is displayed depending on the device version: <ul style="list-style-type: none"> ▪ Supply voltage active ▪ Data transmission active ▪ Device alarm/error has occurred
---------------------------	---

Ex connection data

Safety-related values

Order code for "Output; input 1"	Output type	Safety-related values "Output; input 1"	
		26 (+)	27 (-)
Option BA	Current output 4 to 20 mA HART	$U_N = 30 V_{DC}$ $U_M = 250 V_{AC}$	
Option MA	Modbus RS485	$U_N = 30 V_{DC}$ $U_M = 250 V_{AC}$	

Order code for "Output; input 2"; "Output; input 3" "Output; input 4"	Output type	Safety-related values					
		Output; input 2		Output; input 3		Output; input 4	
		24 (+)	25 (-)	22 (+)	23 (-)	20 (+)	21 (-)
Option B	Current output 4 to 20 mA	$U_N = 30 V_{DC}$ $U_M = 250 V_{AC}$					
Option D	User-configurable input/ output	$U_N = 30 V_{DC}$ $U_M = 250 V_{AC}$					
Option E	Pulse/frequency/switch output	$U_N = 30 V_{DC}$ $U_M = 250 V_{AC}$					
Option F	Double pulse output	$U_N = 30 V_{DC}$ $U_M = 250 V_{AC}$					
Option H	Relay output	$U_N = 30 V_{DC}$ $I_N = 100 mA_{DC}/500 mA_{AC}$ $U_M = 250 V_{AC}$					
Option I	Current input 4 to 20 mA	$U_N = 30 V_{DC}$ $U_M = 250 V_{AC}$					
Option J	Status input	$U_N = 30 V_{DC}$ $U_M = 250 V_{AC}$					

Low flow cut off The switch points for low flow cut off are user-selectable.

Galvanic isolation The outputs are galvanically isolated from one another and from earth (PE).

Protocol-specific data HART

Manufacturer ID	0x11
Device type ID	0x5D (93)
HART protocol revision	7
Device description files (DTM, DD)	Information and files under: www.endress.com
HART load	Min. 250 Ω
System integration	Information on system integration: Operating Instructions →  75. <ul style="list-style-type: none"> ▪ Measured variables via HART protocol ▪ Burst Mode functionality

Modbus RS485

Protocol	Modbus Applications Protocol Specification V1.1
Response times	<ul style="list-style-type: none"> ▪ Direct data access: typically 25 to 50 ms ▪ Auto-scan buffer (data range): typically 3 to 5 ms
Device type	Slave
Slave address range	1 to 247
Broadcast address range	0
Function codes	<ul style="list-style-type: none"> ▪ 03: Read holding register ▪ 04: Read input register ▪ 06: Write single registers ▪ 08: Diagnostics ▪ 16: Write multiple registers ▪ 23: Read/write multiple registers
Broadcast messages	Supported by the following function codes: <ul style="list-style-type: none"> ▪ 06: Write single registers ▪ 16: Write multiple registers ▪ 23: Read/write multiple registers
Supported baud rate	<ul style="list-style-type: none"> ▪ 1 200 BAUD ▪ 2 400 BAUD ▪ 4 800 BAUD ▪ 9 600 BAUD ▪ 19 200 BAUD ▪ 38 400 BAUD ▪ 57 600 BAUD ▪ 115 200 BAUD
Data transfer mode	<ul style="list-style-type: none"> ▪ ASCII ▪ RTU
Data access	Each device parameter can be accessed via Modbus RS485.  For Modbus register information
System integration	Information on system integration: Operating Instructions . <ul style="list-style-type: none"> ▪ Modbus RS485 information ▪ Function codes ▪ Register information ▪ Response time ▪ Modbus data map

Power supply

Terminal assignment

Transmitter: supply voltage, input/outputs

HART

Supply voltage		Input/output 1		Input/output 2		Input/output 3		Input/output 4	
1 (+)	2 (-)	26 (+)	27 (-)	24 (+)	25 (-)	22 (+)	23 (-)	20 (+)	21 (-)
The terminal assignment depends on the specific device version ordered .									

Modbus RS485

Supply voltage		Input/output 1		Input/output 2		Input/output 3		Input/output 4	
1 (+)	2 (-)	26 (B)	27 (A)	24 (+)	25 (-)	22 (+)	23 (-)	20 (+)	21 (-)
The terminal assignment depends on the specific device version ordered .									

Transmitter and sensor connection housing: connecting cable

The sensor and transmitter, which are mounted in separate locations, are interconnected by a connecting cable. The cable is connected via the sensor connection housing and the transmitter housing.

Terminal assignment and connection of the connecting cable:

Proline 500 – digital → 26

Device plugs available



Device plugs may not be used in hazardous areas!

Device plug for connecting to the service interface:

Order code for "Accessory mounted"

option **NB**, adapter RJ45 M12 (service interface) → 24

Order code for "Accessory mounted", option **NB** "Adapter RJ45 M12 (service interface)"

Order code "Accessory mounted"	Cable entry/coupling → 26	
	Cable entry 2	Cable entry 3
NB	Plug M12 × 1	-

Pin assignment, device plug

Service interface

Order code for "Accessories mounted", option **NB**: Adapter RJ45 M12 (service interface)

 <small>A0032047</small>	Pin	Assignment	
	1	+	Tx
	2	+	Rx
	3	-	Tx
	4	-	Rx
Coding		Plug/socket	
D		Socket	



Recommended plug:

- Binder, series 763, part no. 99 3729 810 04
- Phoenix, part no. 1543223 SACC-M12MSD-4Q

Supply voltage	Order code for "Power supply"	Terminal voltage		Frequency range
	Option I		DC24 V	±20%
		AC100 to 240 V	-15...+10%	50/60 Hz

Power consumption	Transmitter		
	Max. 10 W (active power)		
	switch-on current	Max. 36 A (<5 ms) as per NAMUR Recommendation NE 21	

Current consumption	Transmitter		
	<ul style="list-style-type: none"> ▪ Max. 400 mA (24 V) ▪ Max. 200 mA (110 V, 50/60 Hz; 230 V, 50/60 Hz) 		

Power supply failure	<ul style="list-style-type: none"> ▪ Totalizers stop at the last value measured. ▪ Depending on the device version, the configuration is retained in the device memory or in the pluggable data memory (HistoROM DAT). ▪ Error messages (incl. total operated hours) are stored. 		
----------------------	---	--	--

Electrical connection

Connection of connecting cable: Proline 500 – digital

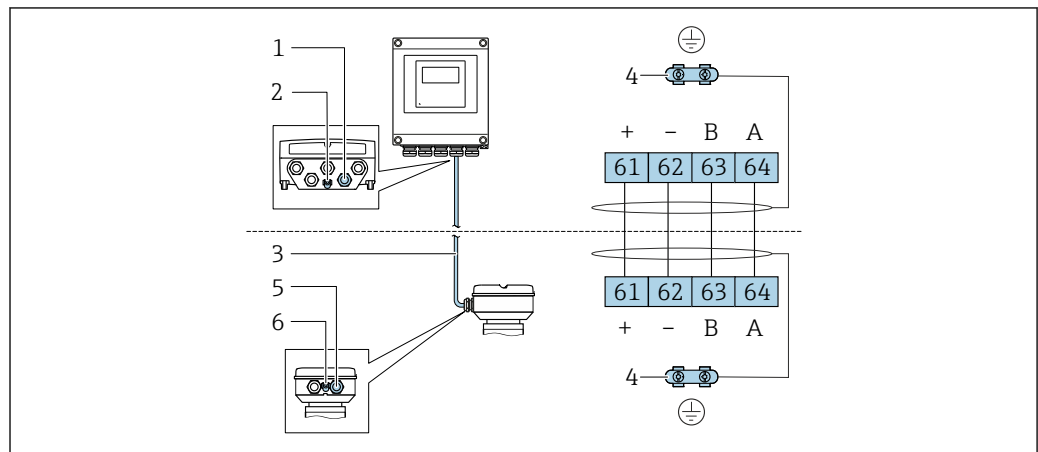

A0028198

- 1 Cable entry for cable on transmitter housing
- 2 Protective ground (PE)
- 3 Connecting cable ISEM communication
- 4 Grounding via ground connection; on device plug versions grounding is through the plug itself
- 5 Cable entry for cable or connection of device plug on sensor connection housing
- 6 Protective ground (PE)

Connection of the connecting cable: Proline 500

The connecting cable is connected via terminals.

Connecting the transmitter

- i** Terminal assignment → 24
- Device plug pin assignment → 24

Connecting the Proline 500 – digital transmitter

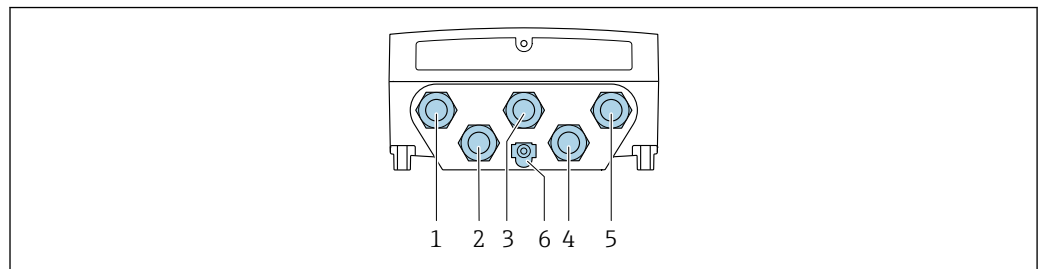

A0028200

- 1 Terminal connection for supply voltage
- 2 Terminal connection for signal transmission, input/output
- 3 Terminal connection for signal transmission, input/output
- 4 Terminal connection for connecting cable between sensor and transmitter
- 5 Terminal connection for signal transmission, input/output; optional: terminal connection for external WLAN antenna
- 6 Protective ground (PE)

- i** An adapter for RJ45 and the M12 connector is optionally available:
Order code for "Accessories", option **NB**: "Adapter RJ45 M12 (service interface)"

The adapter connects the service interface (CDI-RJ45) to an M12 connector mounted in the cable entry. Therefore the connection to the service interface can be established via an M12 connector without opening the device.

- i** Network connection (DHCP client) via service interface (CDI-RJ45) → 64

Connection examples

Current output 4 to 20 mA HART

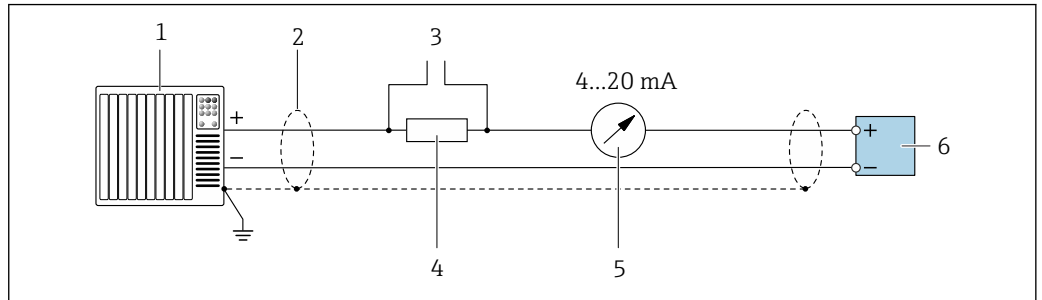

A0029055

3 Connection example for 4 to 20 mA HART current output (active)

- 1 Automation system with current input (e.g. PLC)
- 2 Cable shield provided at one end. The cable shield must be grounded at both ends to comply with EMC requirements; observe cable specifications → 32
- 3 Connection for HART operating devices → 62
- 4 Resistor for HART communication ($\geq 250 \Omega$); observe maximum load → 16
- 5 Analog display unit: observe maximum load → 16
- 6 Transmitter

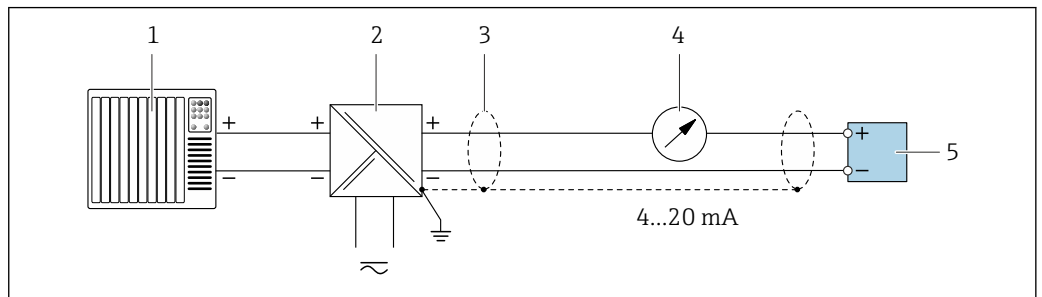

A0028762

4 Connection example for 4 to 20 mA HART current output (passive)

- 1 Automation system with current input (e.g. PLC)
- 2 Power supply
- 3 Cable shield provided at one end. The cable shield must be grounded at both ends to comply with EMC requirements; observe cable specifications → 32
- 4 Analog display unit: observe maximum load → 16
- 5 Transmitter

HART input

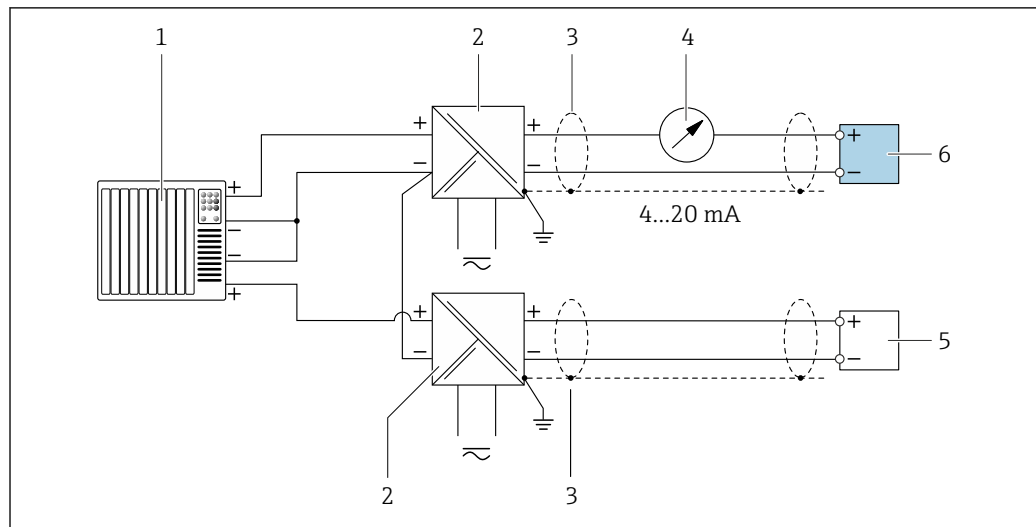

A0028763

5 Connection example for HART input with a common negative (passive)

- 1 Automation system with HART output (e.g. PLC)
- 2 Active barrier for power supply (e.g. RN221N)
- 3 Cable shield provided at one end. The cable shield must be grounded at both ends to comply with EMC requirements; observe cable specifications
- 4 Analog display unit: observe maximum load → 16
- 5 Pressure measuring device (e.g. Cerabar M, Cerabar S): see requirements
- 6 Transmitter

Modbus RS485

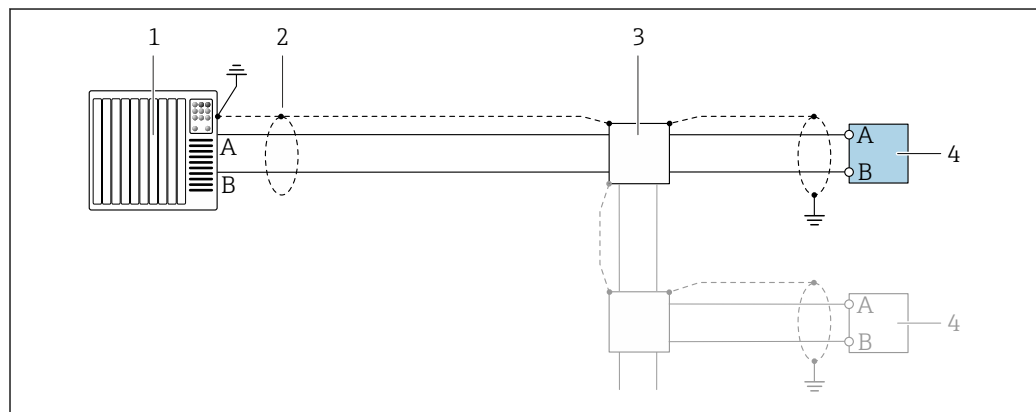

A0028765

6 Connection example for Modbus RS485, non-hazardous area and Zone 2; Class I, Division 2

- 1 Control system (e.g. PLC)
- 2 Cable shield provided at one end. The cable shield must be grounded at both ends to comply with EMC requirements; observe cable specifications
- 3 Distribution box
- 4 Transmitter

Current output 4-20 mA

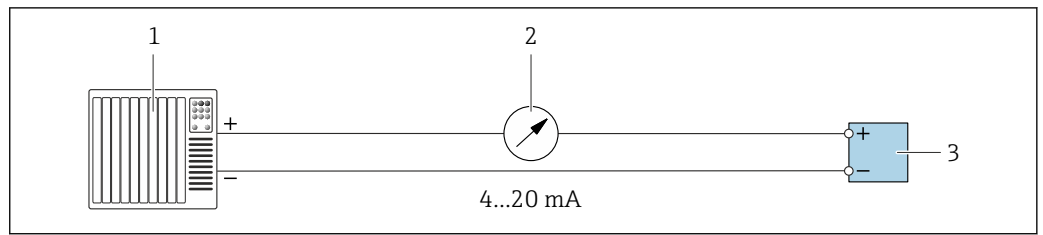

A0028758

7 Connection example for 4-20 mA current output (active)

- 1 Automation system with current input (e.g. PLC)
- 2 Analog display unit: observe maximum load → 16
- 3 Transmitter

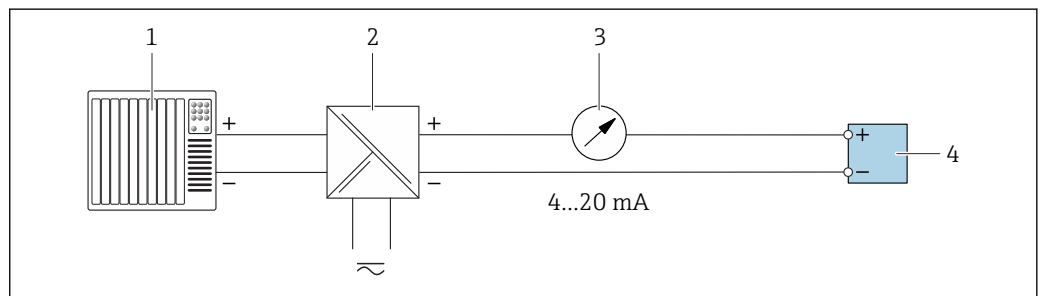

A0028759

8 Connection example for 4-20 mA current output (passive)

- 1 Automation system with current input (e.g. PLC)
- 2 Active barrier for power supply (e.g. RN221N)
- 3 Analog display unit: observe maximum load → 16
- 4 Transmitter

Pulse/frequency output

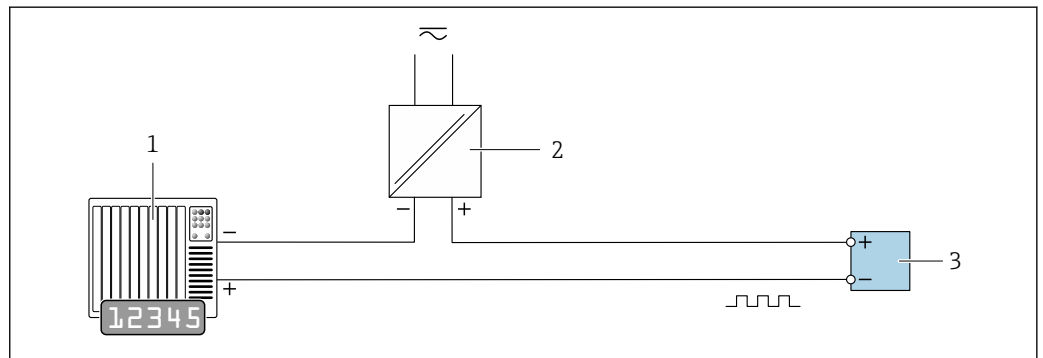

A0028761

9 Connection example for pulse/frequency output (passive)

- 1 Automation system with pulse/frequency input (e.g. PLC)
- 2 Power supply
- 3 Transmitter: Observe input values → 17

Switch output

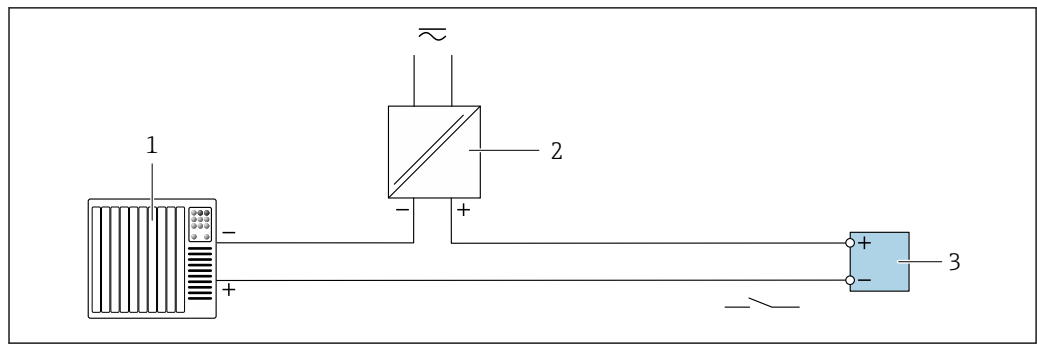

A0028760

10 Connection example for switch output (passive)

- 1 Automation system with switch input (e.g. PLC)
- 2 Power supply
- 3 Transmitter: Observe input values → 17

Double pulse output

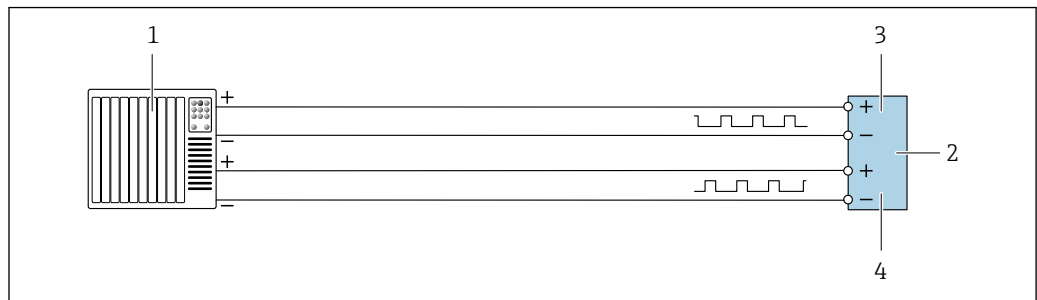

A0029280

11 Connection example for double pulse output (active)

- 1 Automation system with double pulse input (e.g. PLC)
- 2 Transmitter: Observe input values → 19
- 3 Double pulse output
- 4 Double pulse output (slave), phase-shifted

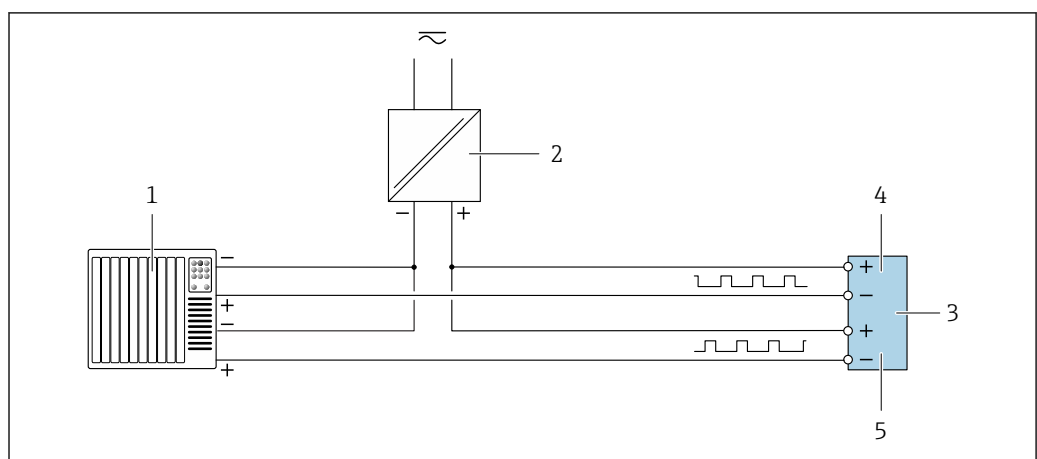

A0029279

12 Connection example for double pulse output (passive)

- 1 Automation system with double pulse input (e.g. PLC)
- 2 Power supply
- 3 Transmitter: Observe input values → 19
- 4 Double pulse output
- 5 Double pulse output (slave), phase-shifted

Relay output

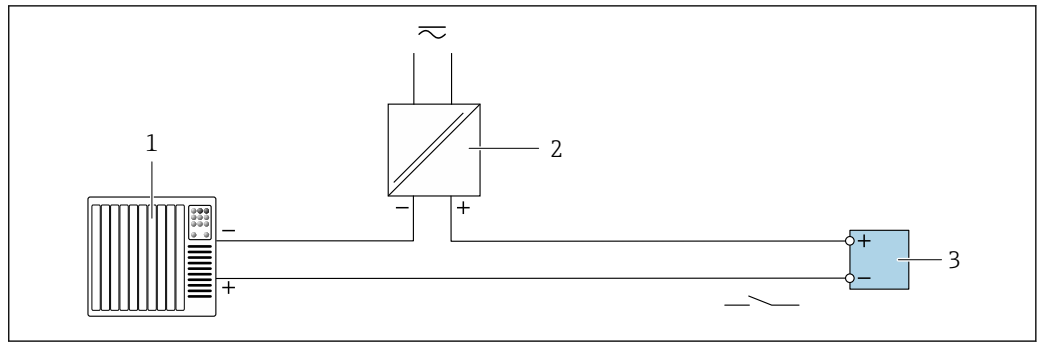

A0028760

13 Connection example for relay output (passive)

- 1 Automation system with relay input (e.g. PLC)
- 2 Power supply
- 3 Transmitter: Observe input values → 20

Current input

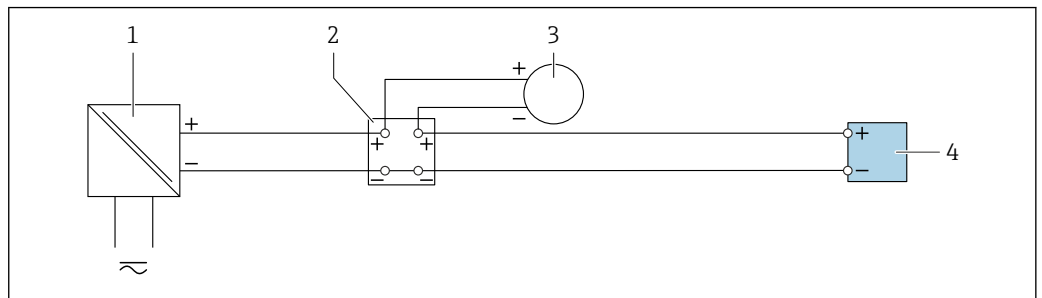

A0028915

14 Connection example for 4 to 20 mA current input

- 1 Power supply
- 2 Terminal box
- 3 External measuring device (to read in pressure or temperature, for instance)
- 4 Transmitter

Status input

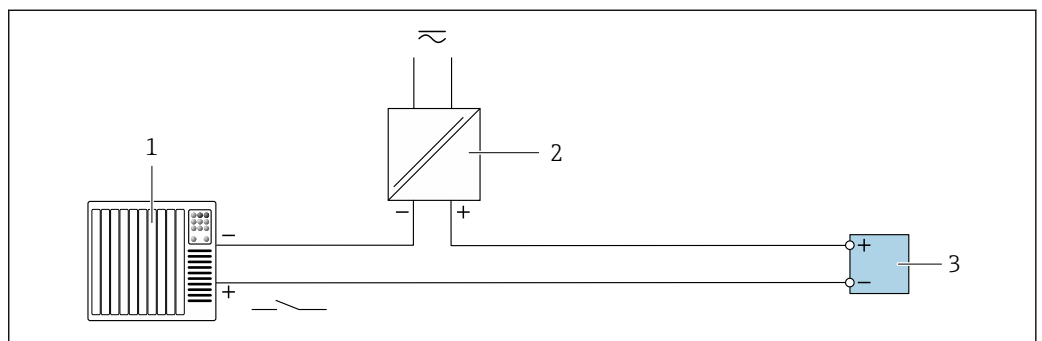

A0028764

15 Connection example for status input

- 1 Automation system with status output (e.g. PLC)
- 2 Power supply
- 3 Transmitter

Potential equalization

Requirements

- Please consider the following to ensure correct measurement:
- Same electrical potential for the fluid and sensor
 - Company-internal grounding concepts

terminals Spring-loaded terminals: Suitable for strands and strands with ferrules.
Conductor cross-section 0.2 to 2.5 mm² (24 to 12 AWG).

Cable entries

- Cable gland: M20 × 1.5 with cable \varnothing 6 to 12 mm (0.24 to 0.47 in)
- Thread for cable entry:
 - NPT ½"
 - G ½"
 - M20
- Only available for certain device versions →  24.

Cable specification

Permitted temperature range

- The installation guidelines that apply in the country of installation must be observed.
- The cables must be suitable for the minimum and maximum temperatures to be expected.

Power supply cable

Standard installation cable is sufficient.

Protective ground cable

Cable ≥ 2.08 mm² (14 AWG)

The grounding impedance must be less than 1 Ω .

Signal cable

Current output 4 to 20 mA HART

A shielded cable is recommended. Observe grounding concept of the plant.

Modbus RS485

The EIA/TIA-485 standard specifies two types of cable (A and B) for the bus line which can be used for every transmission rate. Cable type A is recommended.

Cable type	A
Characteristic impedance	135 to 165 Ω at a measuring frequency of 3 to 20 MHz
Cable capacitance	< 30 pF/m
Wire cross-section	> 0.34 mm ² (22 AWG)
Cable type	Twisted pairs
Loop resistance	≤ 110 Ω /km
Signal damping	Max. 9 dB over the entire length of the cable cross-section
Shield	Copper braided shielding or braided shielding with foil shield. When grounding the cable shield, observe the grounding concept of the plant.

Current output 0/4 to 20 mA

Standard installation cable is sufficient.

Pulse/frequency/switch output

Standard installation cable is sufficient.

Double pulse output

Standard installation cable is sufficient.

Relay output

Standard installation cable is sufficient.

Current input 0/4 to 20 mA

Standard installation cable is sufficient.

Status input

Standard installation cable is sufficient.

Choice of connecting cable between the transmitter and sensor

Depends on the type of transmitter and the installation zones

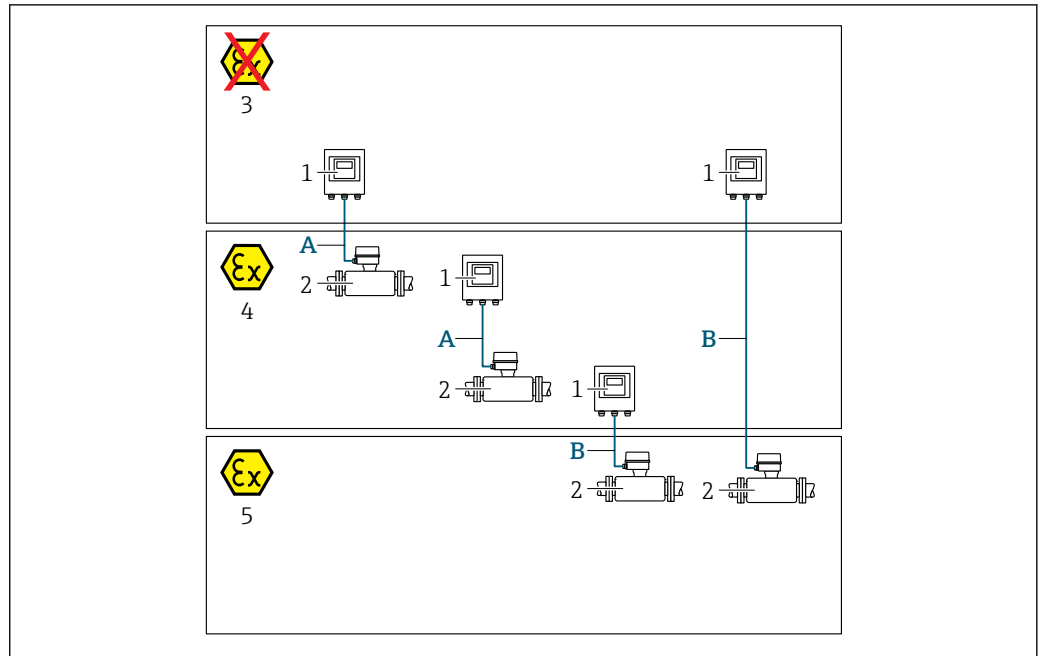

A0035795

- 1 Proline 500 – digital transmitter
- 2 Prosonic Flow sensor
- 3 Non-hazardous area
- 4 Hazardous area: Zone 2; Class I, Division 2
- 5 Hazardous area: Zone 1; Class I, Division 1
- A Standard cable to 500 – digital transmitter → 33
Transmitter installed in the non-hazardous area or hazardous area: Zone 2; Class I, Division 2 / sensor installed in the hazardous area: Zone 2; Class I, Division 2
- B Standard cable to 500 – digital transmitter → 34
Transmitter installed in the hazardous area: Zone 2; Class I, Division 2 / sensor installed in the hazardous area: Zone 1; Class I, Division 1

A: Connecting cable between sensor and transmitter: Proline 500 – digital

Standard cable

A standard cable with the following specifications can be used as the connecting cable.

Design	4 cores (2 pairs); uninsulated stranded CU wires; pair-stranded with common shield
Shielding	Tin-plated copper-braid, optical cover ≥ 85 %
Loop resistance	Power supply line (+, -): maximum 10 Ω
Cable length	Maximum 300 m (1 000 ft), see the following table.

Cross-section	Cable length [max.]
0.34 mm ² (AWG 22)	80 m (270 ft)
0.50 mm ² (AWG 20)	120 m (400 ft)
0.75 mm ² (AWG 18)	180 m (600 ft)
1.00 mm ² (AWG 17)	240 m (800 ft)
1.50 mm ² (AWG 15)	300 m (1 000 ft)

Optionally available connecting cable

Design	2 × 2 × 0.34 mm ² (AWG 22) PVC cable ¹⁾ with common shield (2 pairs, uninsulated stranded CU wires; pair-stranded)
Flame resistance	According to DIN EN 60332-1-2
Oil-resistance	According to DIN EN 60811-2-1
Shielding	Tin-plated copper-braid, optical cover ≥ 85 %
Operating temperature	When mounted in a fixed position: -50 to +105 °C (-58 to +221 °F); when cable can move freely: -25 to +105 °C (-13 to +221 °F)
Available cable length	Fixed: 20 m (65 ft); variable: up to maximum 50 m (165 ft)

1) UV radiation can impair the cable outer sheath. Protect the cable from direct sunshine where possible.

*B: Connecting cable between sensor and transmitter: Proline 500 - digital**Standard cable*

A standard cable with the following specifications can be used as the connecting cable.

Design	4, 6, 8 cores (2, 3, 4 pairs); uninsulated stranded CU wires; pair-stranded with common shield
Shielding	Tin-plated copper-braid, optical cover ≥ 85 %
Capacitance C	Maximum 760 nF IIC, maximum 4.2 µF IIB
Inductance L	Maximum 26 µH IIC, maximum 104 µH IIB
Inductance/resistance ratio (L/R)	Maximum 8.9 µH/Ω IIC, maximum 35.6 µH/Ω IIB (e.g. in accordance with IEC 60079-25)
Loop resistance	Power supply line (+, -): maximum 5 Ω
Cable length	Maximum 150 m (500 ft), see the following table.

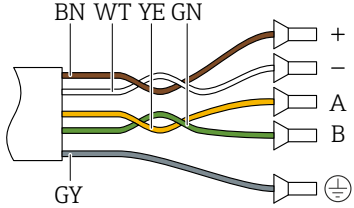
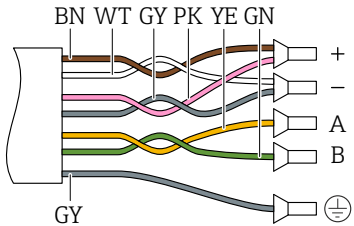
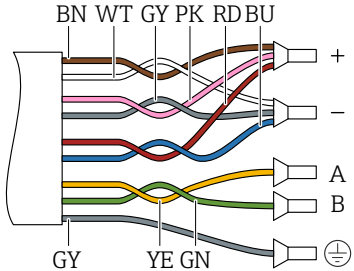
Cross-section	Cable length [max.]	Termination
2 x 2 x 0.50 mm ² (AWG 20)	50 m (165 ft)	2 x 2 x 0.50 mm ² (AWG 20)  <ul style="list-style-type: none"> ■ +, - = 0.5 mm² ■ A, B = 0.5 mm²
3 x 2 x 0.50 mm ² (AWG 20)	100 m (330 ft)	3 x 2 x 0.50 mm ² (AWG 20)  <ul style="list-style-type: none"> ■ +, - = 1.0 mm² ■ A, B = 0.5 mm²
4 x 2 x 0.50 mm ² (AWG 20)	150 m (500 ft)	4 x 2 x 0.50 mm ² (AWG 20)  <ul style="list-style-type: none"> ■ +, - = 1.5 mm² ■ A, B = 0.5 mm²

Optionally available connecting cable

Connecting cable for	Zone 1; Class I, Division 1
Standard cable	2 × 2 × 0.5 mm ² (AWG 20) PVC cable ¹⁾ with common shield (2 pairs, pair-stranded)
Flame resistance	According to DIN EN 60332-1-2
Oil-resistance	According to DIN EN 60811-2-1
Shielding	Tin-plated copper-braid, optical cover ≥ 85 %
Operating temperature	When mounted in a fixed position: -50 to +105 °C (-58 to +221 °F); when cable can move freely: -25 to +105 °C (-13 to +221 °F)
Available cable length	Fixed: 20 m (65 ft); variable: up to maximum 50 m (165 ft)

1) UV radiation can impair the cable outer sheath. Protect the cable from direct sunshine where possible.

Performance characteristics

Reference operating conditions

- Error limits following ISO/DIS 11631
- Calibration gas: dry air
- Accuracy information is based on accredited calibration rigs that are traced to ISO 17025.

Maximum measured error

o.r. = of reading; o.f.s. = of full scale value; abs. = absolute; T = medium temperature

Volume flow



Standard Order code for "Flow calibration", option A "1%"	<ul style="list-style-type: none"> ■ ± 1.0 % o.r. for 3 to 40 m/s (9.84 to 131.2 ft/s) ■ ± 2.0 % o.r. for 0.3 to 3 m/s (0.98 to 9.84 ft/s)
Optional Order code for "Flow calibration", option C "0.50%"	<ul style="list-style-type: none"> ■ ± 0.5 % o.r. for 3 to 40 m/s (9.84 to 131.2 ft/s) ■ ± 1.0 % o.r. for 0.3 to 3 m/s (0.98 to 9.84 ft/s)

 The specification applies for Reynolds numbers $Re \geq 10000$. For Reynolds numbers $Re < 10000$ larger measured errors may occur.

Temperature

Optional (order code for "Measuring tube; Transducer; Sensor version", option AB "316L; Titanium Gr. 2; temperature measurement integrated" or AC "316L; Titanium Gr. 2; pressure + temperature measurement integrated")

$$\pm 0.35 \text{ }^\circ\text{C} \pm 0.002 \cdot T \text{ }^\circ\text{C} (\pm 0.63 \text{ }^\circ\text{F} \pm 0.0011 \cdot (T - 32) \text{ }^\circ\text{F})$$

 The additional measured error caused by heat conduction is not taken into consideration here. The error caused by heat conduction can be reduced by using thermal insulation →  44.

Pressure

Optional (order code for "Measuring tube; Transducer; Sensor version", option AC "316L; Titanium Gr. 2; pressure + temperature measurement integrated")

Order code for "Pressure component"	Nominal value absolute [bar (psi)]	Pressure ranges and measured errors ¹⁾	
		Pressure range, absolute [bar (psi)]	Measured error, absolute
Option B "Pressure measuring cell 2bar/29psi abs"	2 bar (30 psi)	0.01 (0.1) $\leq p \leq$ 0.4 (5.8) 0.4 (5.8) $\leq p \leq$ 2 (29)	± 0.5 % of 0.4 bar (5.8 psi) ± 0.5 % o.r.
Option C "Pressure measuring cell 4bar/58psi abs"	4 bar (60 psi)	0.01 (0.1) $\leq p \leq$ 0.8 (11.6) 0.8 (11.6) $\leq p \leq$ 4 (58)	± 0.5 % of 0.8 bar (11.6 psi) ± 0.5 % o.r.
Option D "Pressure measuring cell 10bar/145psi abs"	10 bar (150 psi)	0.01 (0.1) $\leq p \leq$ 2 (29) 2 (29) $\leq p \leq$ 10 (145)	± 0.5 % of 2 bar (29 psi) ± 0.5 % o.r.
Option E "Pressure measuring cell 40bar/580psi abs"	40 bar (600 psi)	0.01 (0.1) $\leq p \leq$ 8 (116) 8 (116) $\leq p \leq$ 40 (580)	± 0.5 % of 8 bar (116 psi) ± 0.5 % o.r.
Option F "Pressure measuring cell 100bar/1450psi abs"	100 bar (1500 psi)	0.01 (0.1) $\leq p \leq$ 20 (290) 20 (290) $\leq p \leq$ 100 (1450)	± 0.5 % of 20 bar (290 psi) ± 0.5 % o.r.

1) The specific measured errors refer to the position of the measurement in the measuring tube and do not correspond to the pressure in the pipe connection line upstream or downstream from the measuring device.

Sound velocity

± 0.2 % o.r.

Example for max. measured error (volume flow)

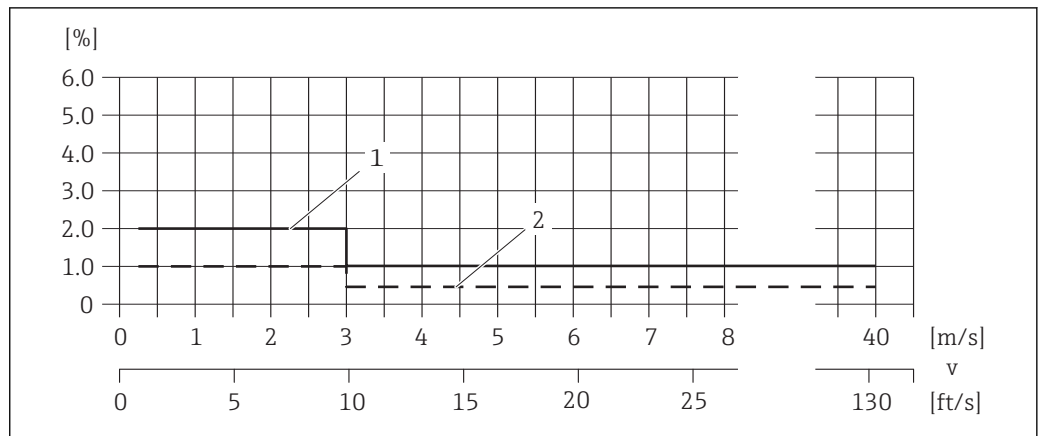

16 Example for max. measured error (volume flow) in % o.r.

- 1 Standard (order code for "Flow calibration", option A "1%")
- 2 Optional (order code for "Flow calibration", option C "0.50%")

Repeatability

o.r. = of reading

Volume flow

- ±0.2 % o.r. for 3 to 40 m/s (9.84 to 131.2 ft/s)
- ±0.4 % o.r. for 0.3 to 3 m/s (0.98 to 9.84 ft/s)

Influence of ambient temperature

Current output

Temperature coefficient	Max. 1 $\mu\text{A}/^\circ\text{C}$
-------------------------	-------------------------------------

Pulse/frequency output

Temperature coefficient	No additional effect. Included in accuracy.
-------------------------	---

Installation

No special measures such as supports etc. are necessary. External forces are absorbed by the construction of the device.

Mounting location

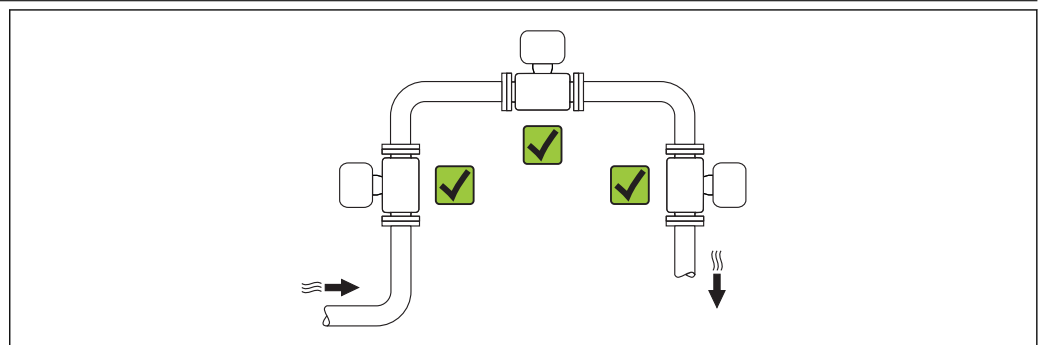

Orientation

The direction of the arrow on the sensor helps you to install the sensor according to the flow direction (direction of medium flow through the piping).

- Install the measuring device in a parallel plane free of external mechanical stress.
- The internal diameter of the pipe must match the internal diameter of the sensor.

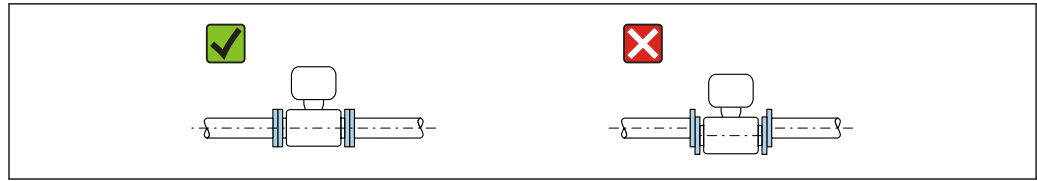

A0015895

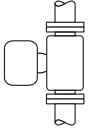
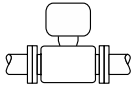
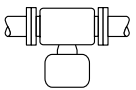
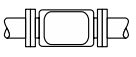
Orientation		Compact version	
A	Vertical orientation	 A0015545	✓✓
B	Horizontal orientation, transmitter head up ¹⁾	 A0015589	✓✓
C	Horizontal orientation, transmitter head down ¹⁾	 A0015590	✓
D	Horizontal orientation, transmitter head at side	 A0015592	✗

1) The horizontal alignment of the transducers may only deviate by a maximum of $\pm 5^\circ$, particularly if a liquid is present in the medium (wet gas).

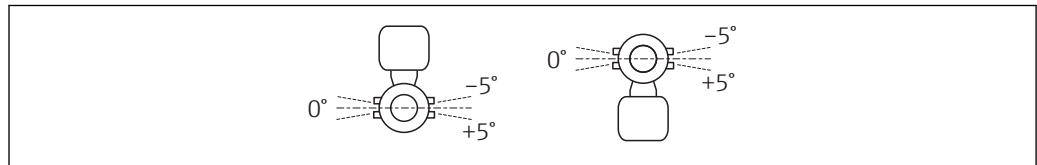

A0037650

Inlet and outlet runs

If possible, the sensor should be installed upstream from valves, T-pieces, elbows etc. To attain the specified level of accuracy of the measuring device, the below mentioned inlet and outlet runs must be maintained at minimum. If there are several flow disturbances present, the longest specified inlet run must be maintained.

Single-path version: DN 25 (1")

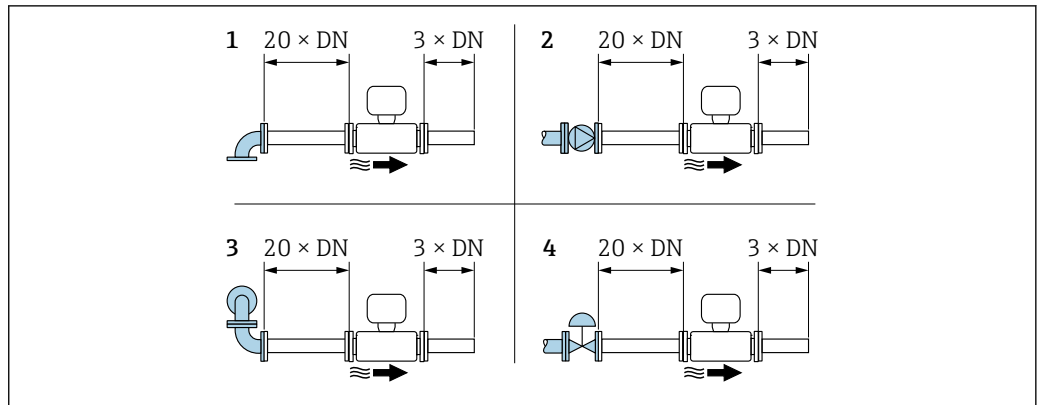

A0015453

17 Single-path version: minimum inlet and outlet runs with various flow obstructions

- 1 90° elbow or T-section
- 2 Pump
- 3 2 × 90° elbow, 3-dimensional
- 4 Control valve

Two-path version: DN 50 to 300 (2 to 12")

i With order code for "Calibration flow", option C "0.50%" and option D "0.50%", traceable to ISO/IEC17025:
Inlet run = 20 × DN

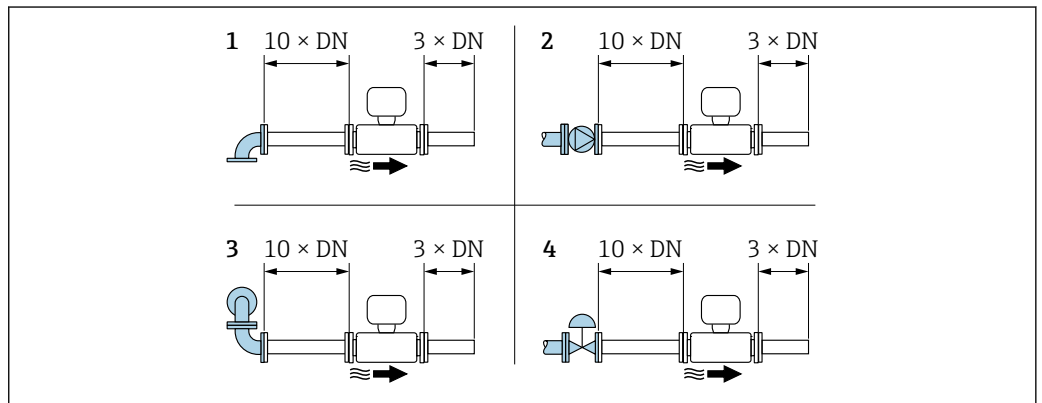

A0015553

18 Two-path version: minimum inlet and outlet runs with various flow obstructions

- 1 90° elbow or T-section
- 2 Pump
- 3 2 × 90° elbow, 3-dimensional
- 4 Control valve

Outlet runs when installing external devices

If installing an external device, observe the specified distance.

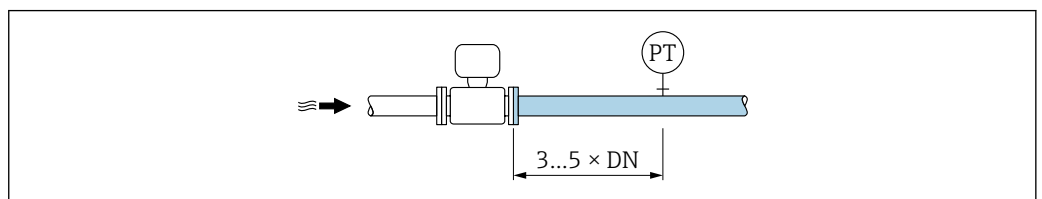

A0015901

PT External device, e.g. temperature sensor, pressure measuring cell

Mounting the transmitter housing

Proline 500 – digital transmitter

Post mounting

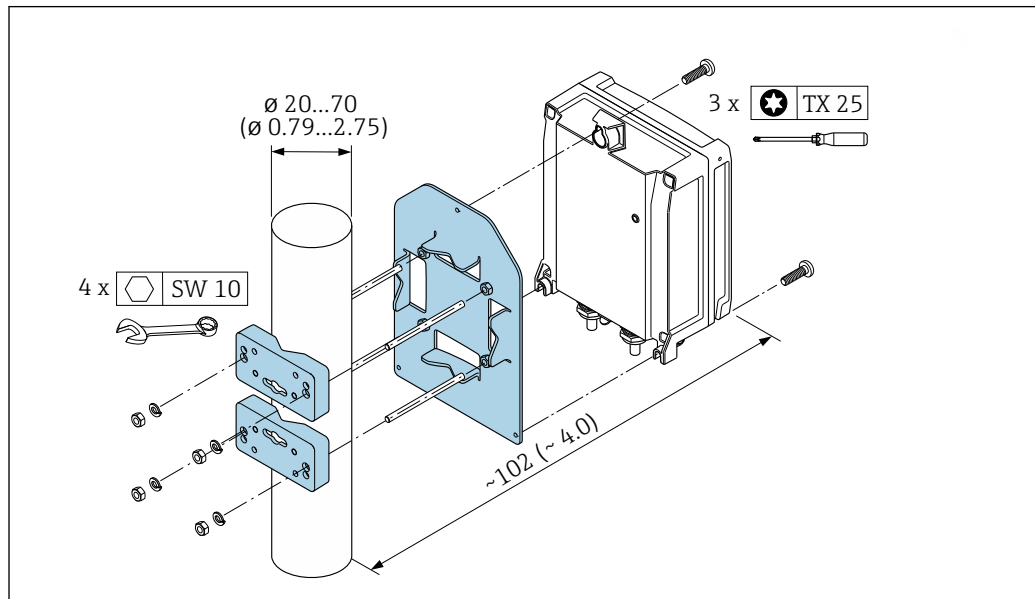

A0029051

19 Engineering unit mm (in)

Wall mounting

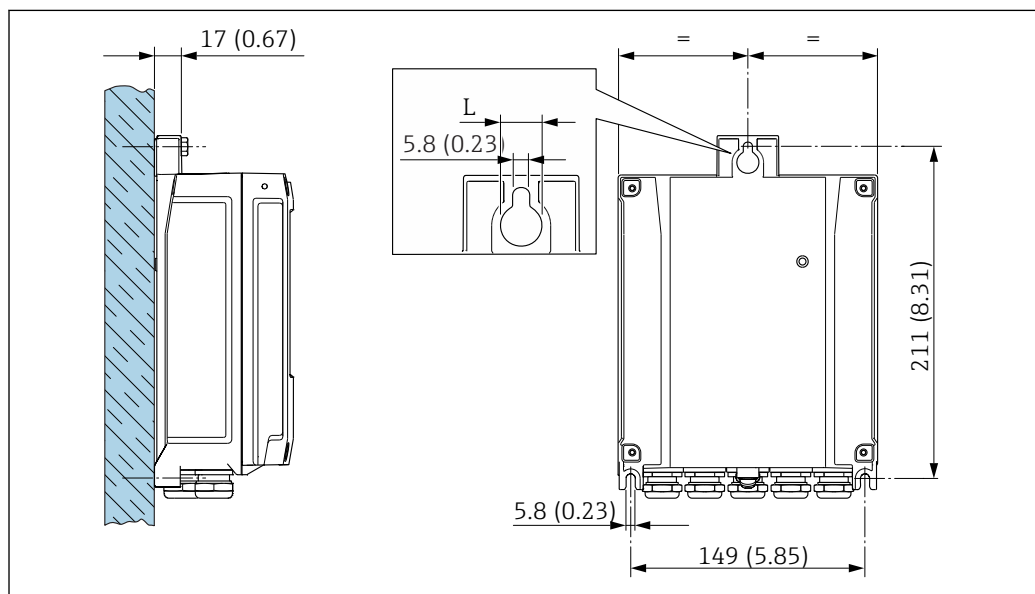

A0029054

20 Engineering unit mm (in)

L Depends on order code for "Transmitter housing"

Order code for "Transmitter housing"

- Option A, aluminum coated: L = 14 mm (0.55 in)
- Option D, polycarbonate: L = 13 mm (0.51 in)

Special mounting instructions

Rupture disk

Information that is relevant to the process: → 44.

The position of the rupture disk is indicated on a sticker applied over it. If the rupture disk is triggered, the sticker is destroyed. The disk can therefore be visually monitored.

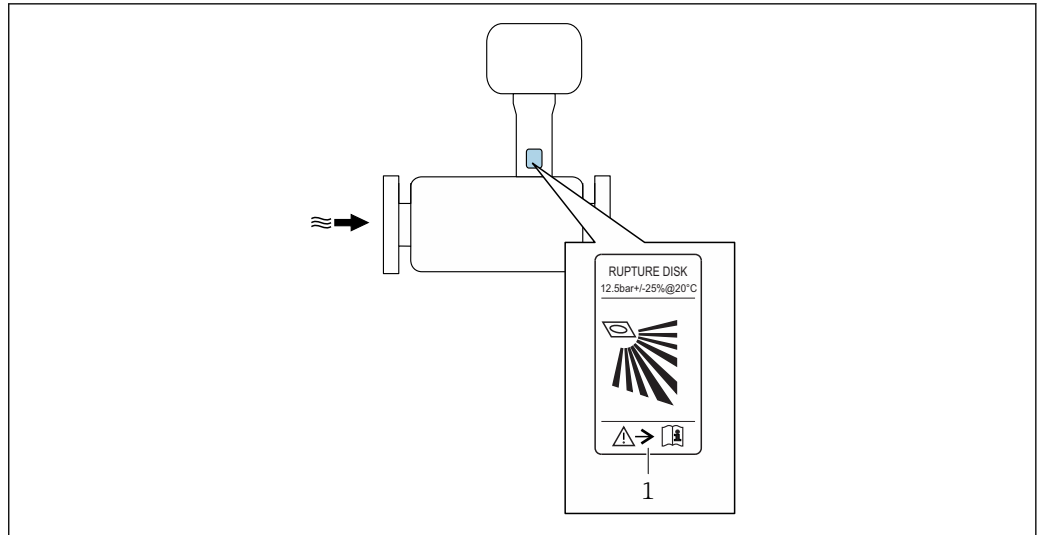

A0037501

1 Rupture disk label

Protective cover

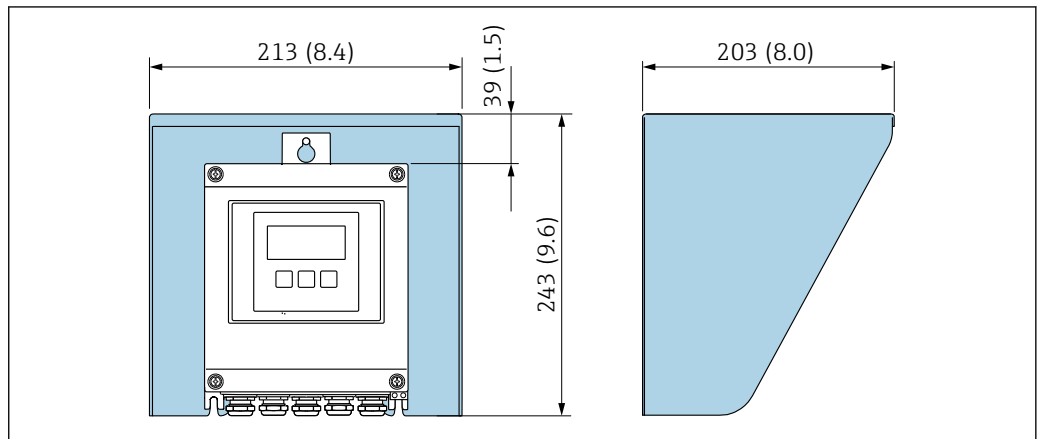

A0029552

21 Weather protection cover for Proline 500 – digital

Environment

Ambient temperature range

Measuring device	<ul style="list-style-type: none"> ▪ Standard: -40 to +60 °C (-40 to +140 °F) ▪ Optional order code for "Test, certificate", option JP: -50 to +60 °C (-58 to +140 °F)
Readability of the local display	<p>-20 to +60 °C (-4 to +140 °F)</p> <p>The readability of the display may be impaired at temperatures outside the temperature range.</p>

- ▶ If operating outdoors:
Avoid direct sunlight, particularly in warm climatic regions.

 You can order a weather protection cover from Endress+Hauser. →  72.

Storage temperature

All components apart from display modules:
-40 to +80 °C (-40 to +176 °F), preferably at +20 °C (+68 °F)

Display modules

-40 to +80 °C (-40 to +176 °F)

Degree of protection**Transmitter**

- As standard: IP66/67, type 4X enclosure
- When housing is open: IP20, type 1 enclosure
- Display module: IP20, type 1 enclosure

Sensor

As standard: IP66/67, type 4X enclosure

External WLAN antenna

IP67

Vibration- and shock-resistance**Vibration sinusoidal, according to IEC 60068-2-6**

- 2 to 8.4 Hz, 7.5 mm peak
- 8.4 to 2 000 Hz, 2 g peak

Vibration broad-band random, according to IEC 60068-2-64

- 10 to 200 Hz, 0.01 g²/Hz
- 200 to 2 000 Hz, 0.003 g²/Hz
- Total: 2.70 g rms

Shock half-sine, according to IEC 60068-2-27

6 ms 50 g

Rough handling shocks according to IEC 60068-2-31**Electromagnetic compatibility (EMC)**

As per IEC/EN 61326 and NAMUR Recommendation 21 (NE 21)



Details are provided in the Declaration of Conformity.

Process

Medium temperature range**Sensor**

- Without integrated pressure measuring cell: -50 to +150 °C (-58 to +302 °F)
- With integrated pressure measuring cell: -50 to +100 °C (-58 to +212 °F)

Medium pressure range

Min. medium pressure: 0.7 bar (10.2 psi) absolute

The maximum permitted medium pressure is defined by the pressure/temperature curves (→  43) and the pressure specifications of the integrated pressure measuring cell (optional; order code for "Measuring tube; transducer; sensor version", option AC "316L; Titanium Gr. 2; pressure + temperature measurement integrated").

⚠ WARNING

The maximum pressure for the measuring device depends on the lowest-rated element with regard to pressure.

- ▶ Note specifications regarding the pressure range of the pressure measuring cell.
- ▶ The Pressure Equipment Directive (2014/68/EU) uses the abbreviation "PS". The abbreviation "PS" corresponds to the MWP (maximum working pressure) of the pressure measuring cell.
- ▶ The MWP for the pressure measuring cell depends on the lowest-rated element, with regard to pressure, of the selected components, i.e. the process connection must be taken into consideration in addition to the pressure measuring cell. Also take the pressure/temperature dependency into consideration.
- ▶ The MWP may be applied at the device for an unlimited period. The MWP is indicated on the nameplate. This value refers to a reference temperature of +20 °C (+68 °F) and may be applied to the pressure measuring cell for an unlimited time.
- ▶ The OPL (over pressure limit = sensor overload limit) for the measuring device depends on the lowest-rated element, with regard to pressure, of the selected components, i.e. the process connection has to be taken into consideration in addition to the pressure measuring cell. Also take the pressure/temperature dependency into consideration.
- ▶ The test pressure corresponds to the over pressure limit of the pressure measuring cell and may be applied only temporarily to ensure that the measurement is within the specifications and no permanent damage occurs.

Pressure measuring cell	Maximum sensor measuring range		MWP	OPL
	Lower (LRL)	Upper (URL)		
	[bar (psi)]	[bar (psi)]	[bar (psi)]	[bar (psi)]
2 bar (30 psi)	0 (0)	+2 (+30)	6.7 (100.5)	10 (150)
4 bar (60 psi)	0 (0)	+4 (+60)	10.7 (160.5)	16 (240)
10 bar (150 psi)	0 (0)	+10 (+150)	25 (375)	40 (600)
40 bar (600 psi)	0 (0)	+40 (+600)	100 (1500)	160 (2400)
100 bar (1500 psi)	0 (0)	+100 (+1500)	100 (1500)	160 (2400)

Pressure-temperature ratings

The following pressure/temperature diagrams apply to all pressure-bearing parts of the device and not just the process connection. The diagrams show the maximum permissible medium pressure depending on the specific medium temperature.

Welding neck flange according to DIN EN 1092-1, PN 16/40/63/100

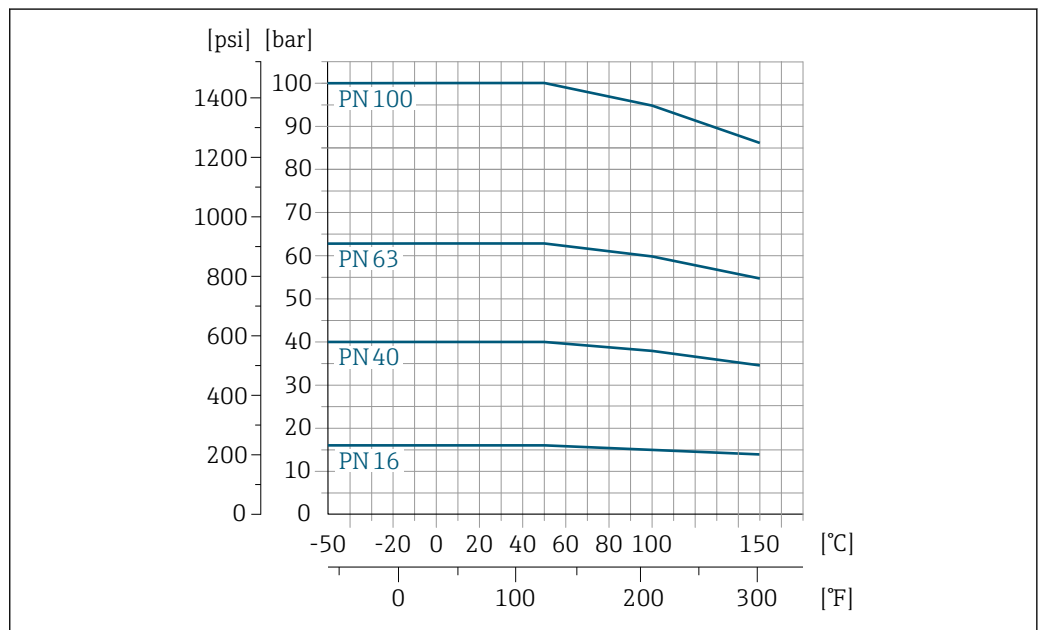

22 With flange material 1.4404 (316, 316L)

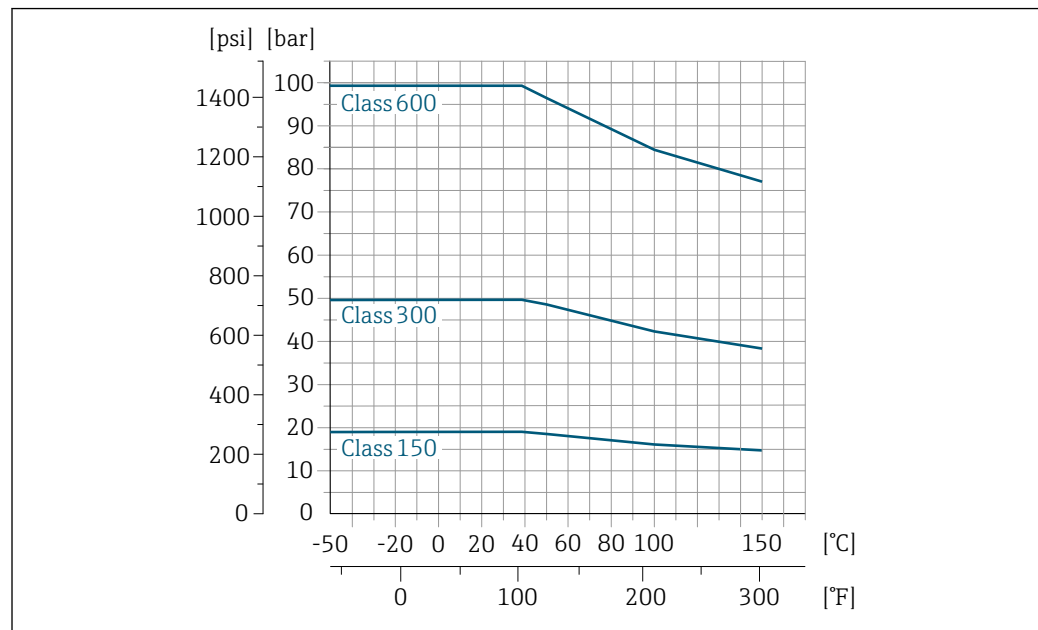
Welding neck flange according to ASME B16.5²⁾, Class 150/300/600

23 With flange material 1.4404 (316, 316L)

Rupture disk

The neck of the measuring device is always fitted with a rupture disk with a triggering pressure of 10 to 15 bar (145 to 217.5 psi). The rupture disk is used for leak detection and for the controlled release of pressure in the neck of the measuring device. The measuring device with an installed rupture disk meets the dual seal requirements of ANSI/ISA-12.27.01.

Flow limit

The diameter of the pipe and the flow rate determine the nominal diameter of the sensor.

i For an overview of the full scale values for the measuring range, see the "Measuring range" section → 11

- The minimum recommended full scale value is approx. 1/20 of the maximum full scale value.
- In most applications, 10 to 50 % of the maximum full scale value can be considered ideal.

Pressure loss

No pressure loss occurs if the sensor is installed in a pipe with the same nominal diameter.

Thermal insulation

For optimum measurement performance, make sure that no heat transfer (heat loss or heat supply) can take place at the sensor. This can be ensured by installing thermal insulation. The formation of condensation in the measuring device can also be limited in this way.

Thermal insulation is particularly recommended in situations in which the difference between the process temperature and ambient temperature is large. This difference leads to an error during temperature measurement that is caused by heat conduction (known as the "heat conduction error").

⚠ WARNING**Electronics overheating on account of thermal insulation!**

- ▶ Recommended orientation: horizontal orientation, sensor connection housing pointing downwards.
- ▶ Do not insulate the sensor connection housing.
- ▶ Maximum permissible temperature at the lower end of the sensor connection housing: 80 °C (176 °F)
- ▶ Thermal insulation with extended neck free: We recommend that you do not insulate the extended neck in order to ensure optimum dissipation of heat.

The thermal insulation should never cover the transmitter housing and the pressure measuring cell.

2) Material group 2.2

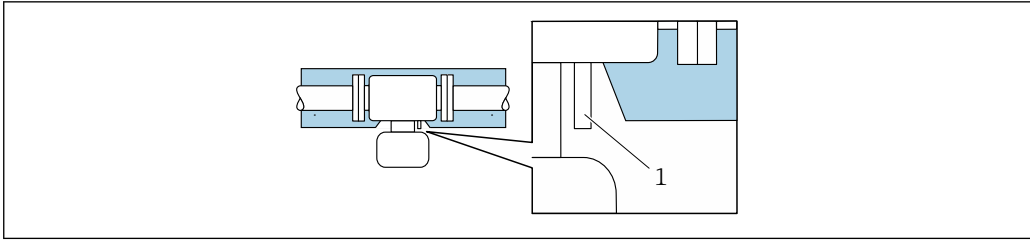

A0037676

24 Thermal insulation with free extended neck and pressure measuring cell

1 Pressure measuring cell

Mechanical construction

Dimensions in SI units

Housing of Proline 500 – digital transmitter

Non-hazardous area or hazardous area: Zone 2; Class I, Division 2

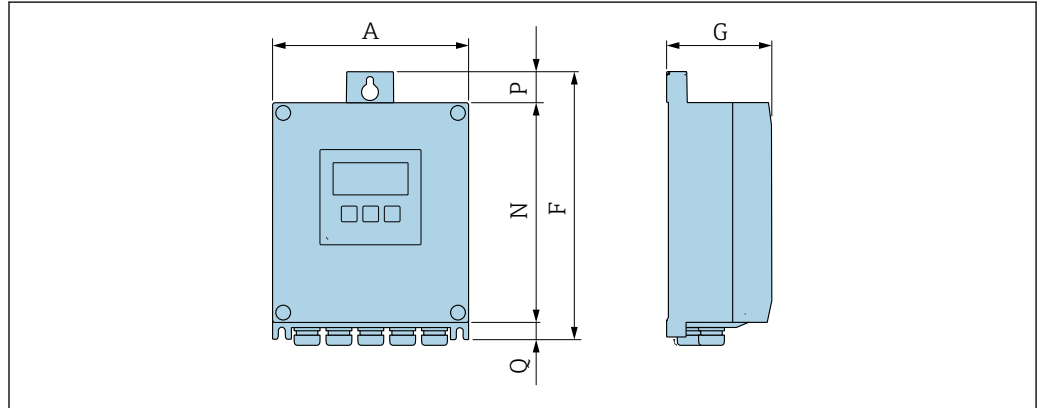

A0033789

Order code for "Transmitter housing", option A "Aluminum, coated" and order code for "Integrated ISEM electronics", option A "Sensor"

A [mm]	F [mm]	G [mm]	N [mm]	P [mm]	Q [mm]
167	232	80	187	24	21

Order code for "Transmitter housing", option D "Polycarbonate" and order code for "Integrated ISEM electronics", option A "Sensor"

A [mm]	F [mm]	G [mm]	N [mm]	P [mm]	Q [mm]
177	234	90	197	17	22

Sensor connection housing

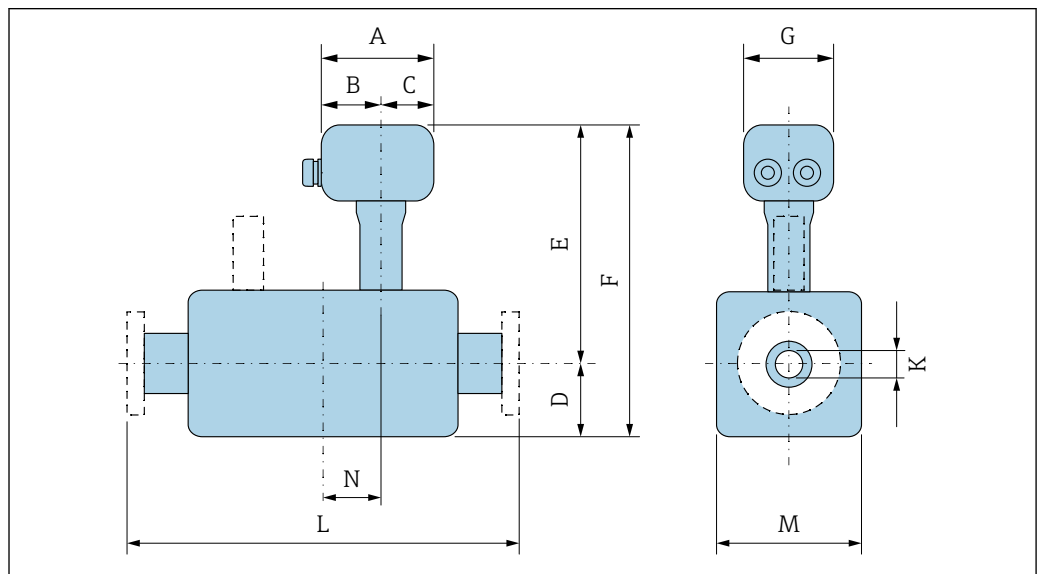

A0038135

Order code for "Sensor connection housing", option A "Aluminum, coated"

DN	A ¹⁾	B ¹⁾	C	D	E	F	G	K	L	M	N
[mm]	[mm]	[mm]	[mm]	[mm]	[mm]	[mm]	[mm]	[mm]	[mm]	[mm]	[mm]
25	148	94	54	20	337	357	136	24.3	²⁾	143	47
50	148	94	54	32	350	382	136	49.2	²⁾	225	63
80	148	94	54	44	362	406	136	73.7	²⁾	245	55
100	148	94	54	57	371	428	136	97.2	²⁾	265	72
150	148	94	54	84	397	481	136	146.3	²⁾	308	62
200	148	94	54	110	423	533	136	193.7	²⁾	349	78
250	148	94	54	138	450	588	136	242.9	²⁾	390	84
300	148	94	54	163	476	639	136	288.9	²⁾	430	96

- 1) Depending on the cable gland used: values up to + 30 mm
- 2) Depends on the process connection in question → 48

Order code for "Sensor connection housing", option L "Cast, stainless"

DN	A ¹⁾	B ¹⁾	C	D	E	F	G	K	L	M	N
[mm]	[mm]	[mm]	[mm]	[mm]	[mm]	[mm]	[mm]	[mm]	[mm]	[mm]	[mm]
25	145	86	59	20	334	354	136	24.3	²⁾	143	47
50	145	86	59	32	346.5	378.5	136	49.2	²⁾	225	63
80	145	86	59	44	358.5	402.5	136	73.7	²⁾	245	55
100	145	86	59	57	367.5	424.5	136	97.2	²⁾	265	72
150	145	86	59	84	393.5	477.5	136	146.3	²⁾	308	62
200	145	86	59	110	419.5	529.5	136	193.7	²⁾	349	78
250	145	86	59	138	447	585	136	242.9	²⁾	390	84
300	145	86	59	163	472.5	635.5	136	288.9	²⁾	430	96

- 1) Depending on the cable gland used: values up to + 30 mm
- 2) Depends on the process connection in question → 48

Pressure measuring cell

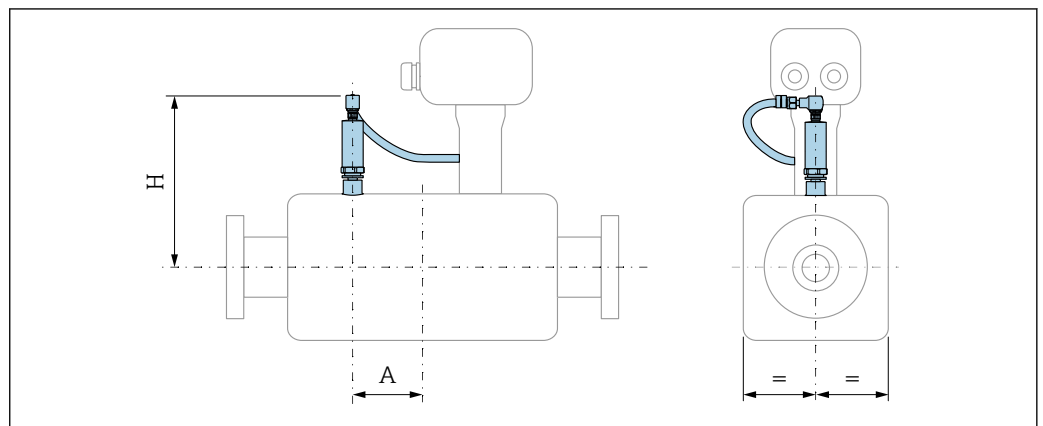

A0038137

Order code for "Pressure component": Options B/C/D/E/F "Pressure measuring cell 2/4/10/40/100 bar absolute"		
DN [mm]	A [mm]	B [mm]
25	61	172
50	76	187
80	96	201
100	85	213
150	74	240
200	87	269
250	102	299
300	110	326

Flange connections

Welding neck flange EN 1092-1-B1, ASME B16.5

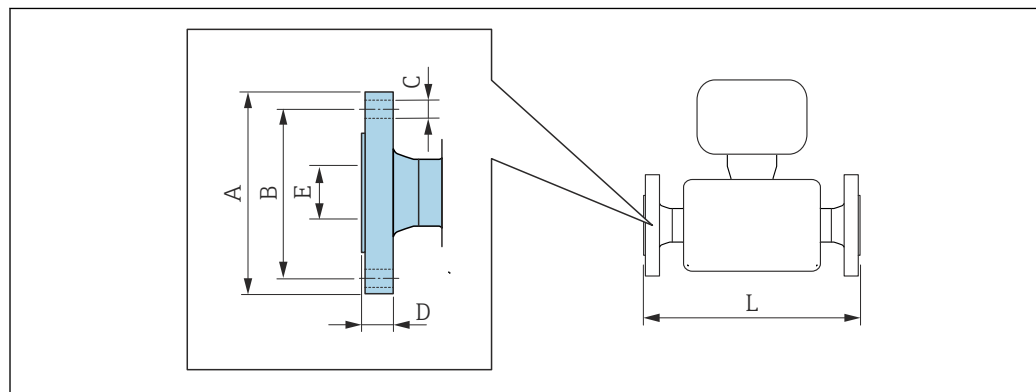

A0015621

- i** Length tolerance for dimension L in mm:
- DN ≤ 100: +1.5 / -2.0
 - DN ≥ 125: +3.5

Flange according to EN 1092-1-B1: PN 16 1.4404 (316, 316L): Order code for "Process connection", option D1S						
DN [mm]	A [mm]	B [mm]	C [mm]	D [mm]	E [mm]	L [mm]
25	-	-	-	-	-	-
50	-	-	-	-	-	-
80	-	-	-	-	-	-
100	220	180	8 × Ø18	20	107.1	399
150	285	240	8 × Ø22	22	159.3	399
200	340	295	8 × Ø22	24	206.5	399
250	405	355	12 × Ø26	26	260.5	449
300	460	410	12 × Ø26	28	309.7	499

Surface roughness (flange): EN 1092-1-B1, Ra 3.2 to 12.5 µm

Flange according to EN 1092-1-B1: PN 40						
1.4404 (316, 316L): Order code for "Process connection", option D2S						
DN [mm]	A [mm]	B [mm]	C [mm]	D [mm]	E [mm]	L [mm]
25	95	65	4 × Ø14	18	28.5	299
50	165	125	4 × Ø18	20	54.5	349
80	200	160	8 × Ø18	24	82.5	399
100	235	190	8 × Ø22	24	107.1	399
150	300	250	8 × Ø26	28	159.3	399
200	375	320	8 × Ø30	34	206.5	451
250	450	385	12 × Ø33	38	258.9	519
300	515	450	12 × Ø33	42	307.9	573
Surface roughness (flange): EN 1092-1-B1, Ra 3.2 to 12.5 µm						

Flange according to EN 1092-1-B1: PN 63						
1.4404 (316, 316L): Order code for "Process connection", option D3W						
DN [mm]	A [mm]	B [mm]	C [mm]	D [mm]	E [mm]	L [mm]
25	-	-	-	-	-	-
50	180	135	4 × Ø22	26	54.5	371
80	215	170	8 × Ø22	28	81.7	429
100	250	200	8 × Ø26	30	106.3	419
150	345	280	8 × Ø33	36	157.1	433
200	415	345	8 × Ø36	42	204.9	495
250	470	400	12 × Ø36	46	255.5	559
300	530	460	12 × Ø36	52	301.9	623
Surface roughness (flange): EN 1092-1-B1, Ra 3.2 to 12.5 µm						

Flange according to EN 1092-1-B1: PN 100						
1.4404 (316, 316L): Order code for "Process connection", option D4W						
DN [mm]	A [mm]	B [mm]	C [mm]	D [mm]	E [mm]	L [mm]
25	105	75	4 × Ø18	24	28.5	329
50	195	145	4 × Ø26	28	53.9	383
80	230	180	8 × Ø26	32	80.9	441
100	265	210	8 × Ø30	36	104.3	443
150	355	290	12 × Ø33	44	154.2	473
200	430	360	12 × Ø36	52	199.1	535
250	505	430	12 × Ø39	60	248.1	623
300	585	500	12 × Ø42	68	295.5	683
Surface roughness (flange): EN 1092-1 Form B2 (DIN 2526 Form E), Ra 0.8 to 3.2 µm						

Flange according to ASME B16.5: Class 150 RF Schedule 40 1.4404 (316, 316L): Order code for "Process connection", option AAS						
DN [mm]	A [mm]	B [mm]	C [mm]	D [mm]	E [mm]	L [mm]
25	88.9	60.5	4 × Ø15.7	14.2	26.7	299
50	152.4	120.7	4 × Ø19.1	19.1	52.6	349
80	190.5	152.4	4 × Ø19.1	23.9	78	399
100	228.6	190.5	8 × Ø19.1	24.5	102.4	399
150	279.4	241.3	8 × Ø22.4	25.4	154.2	399
200	345	298.5	8 × Ø22.3	29	202.7	477
250	405	362	12 × Ø25.4	30.6	254.6	511
300	485	431.8	12 × Ø25.4	32.2	303.1	569
Surface roughness (flange): Ra 3.2 to 6.3 µm						

Flange according to ASME B16.5: Class 300 RF Schedule 40 1.4404 (316, 316L): Order code for "Process connection", option ABS						
DN [mm]	A [mm]	B [mm]	C [mm]	D [mm]	E [mm]	L [mm]
25	95.2	66.5	4 × Ø19.1	17.5	26.4	299
50	165.1	127	8 × Ø19.1	22.4	52.6	349
80	209.6	168.1	8 × Ø22.4	28.4	78	399
100	254	200.2	8 × Ø22.4	31.8	102.4	399
150	317.5	269.7	12 × Ø22.4	36.6	154.2	399
200	380	330.2	12 × Ø25.4	41.7	202.7	497
250	445	387.4	16 × Ø28.6	48.1	254.6	543
300	520	450.8	16 × Ø31.8	51.3	303.1	601
Surface roughness (flange): Ra 3.2 to 6.3 µm						

Flange according to ASME B16.5: Class 300 RF Schedule 80 1.4404 (316, 316L): Order code for "Process connection", option AGS						
DN [mm]	A [mm]	B [mm]	C [mm]	D [mm]	E [mm]	L [mm]
25	95.2	66.5	4 × Ø19.1	17.5	24.3	299
50	165.1	127	8 × Ø19.1	22.4	49.2	349
80	209.6	168.1	8 × Ø22.4	28.4	73.7	399
100	254	200.2	8 × Ø22.4	31.8	97	399
150	317.5	269.7	12 × Ø22.4	36.6	146.3	399
200	380	330.2	12 × Ø25.4	41.7	193.7	497
250	445	387.4	16 × Ø28.6	48.1	242.8	543
300	520	450.8	16 × Ø31.8	51.3	288.9	601
Surface roughness (flange): Ra 3.2 to 6.3 µm						

Flange according to ASME B16.5: Class 600 RF Schedule 80 1.4404 (316, 316L): Order code for "Process connection", option ACS						
DN [mm]	A [mm]	B [mm]	C [mm]	D [mm]	E [mm]	L [mm]
25	95.3	66.5	4 × Ø19.1	24.5	24.3	329
50	165	127	8 × Ø19.1	32.4	49.2	407
80	210	168.3	8 × Ø22.2	38.8	73.7	465
100	275	215.9	8 × Ø25.4	45.1	97	481
150	355	292.1	12 × Ø28.6	54.7	146.3	491
200	420	349.2	12 × Ø31.8	62.6	193.7	553
250	510	431.8	16 × Ø35.0	70.5	242.8	625
300	560	489	16 × Ø35.0	73.7	288.9	665

Surface roughness (flange): Ra 3.2 to 6.3 µm

Accessories

Protective cover

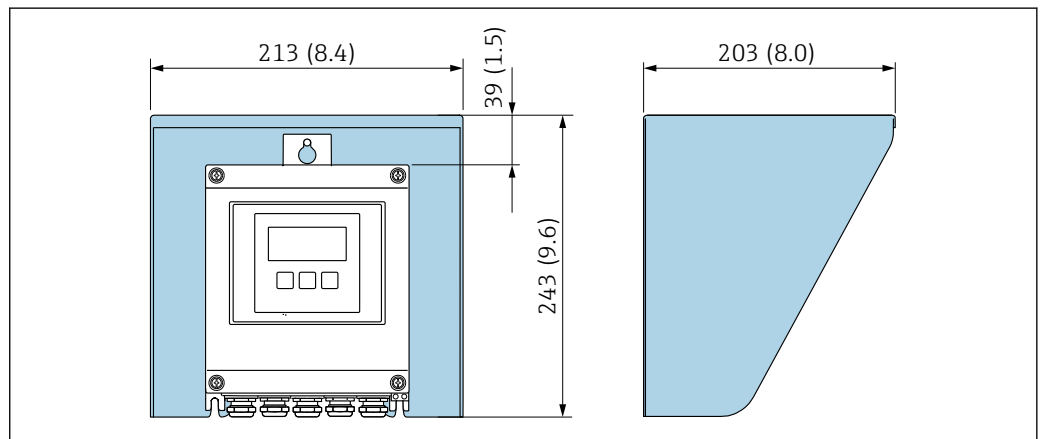

25 Weather protection cover for Proline 500 – digital

External WLAN antenna

i The external WLAN antenna is not suitable for use in hygienic applications.

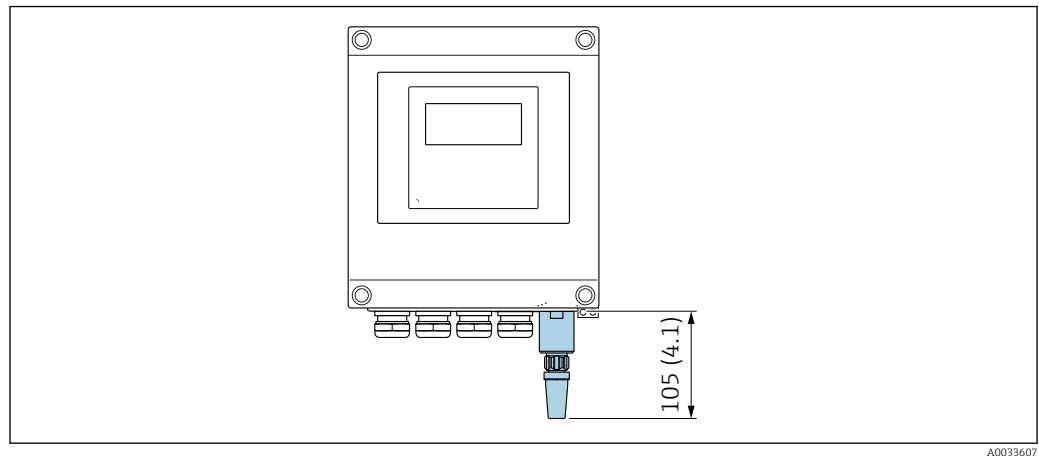
*Proline 500 – digital**External WLAN antenna mounted on device*

26 Engineering unit mm (in)

External WLAN antenna mounted with cable

The external WLAN antenna can be mounted separately from the transmitter if the transmission/reception conditions at the transmitter mounting location are poor.

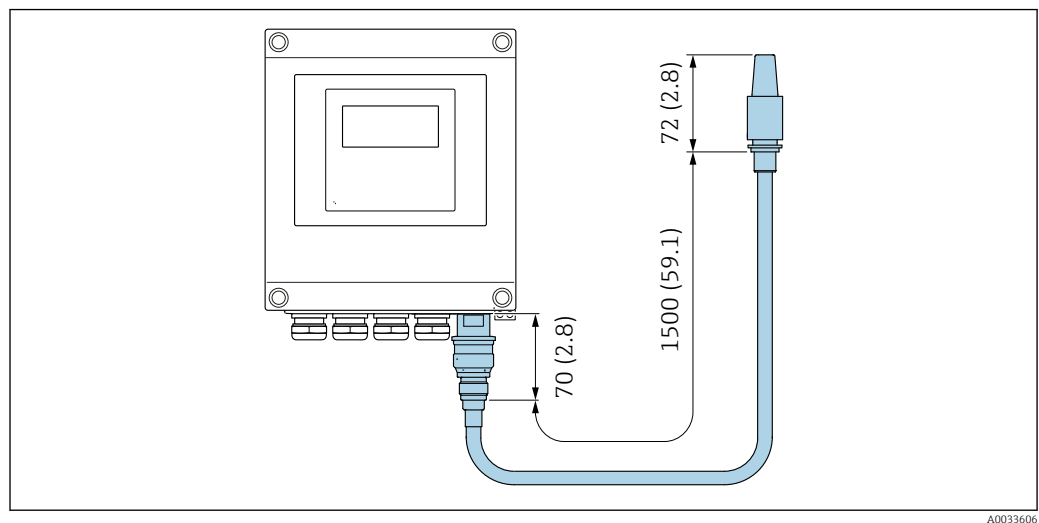

27 Engineering unit mm (in)

Dimensions in US units

Housing of Proline 500 – digital transmitter

Non-hazardous area or hazardous area: Zone 2; Class I, Division 2

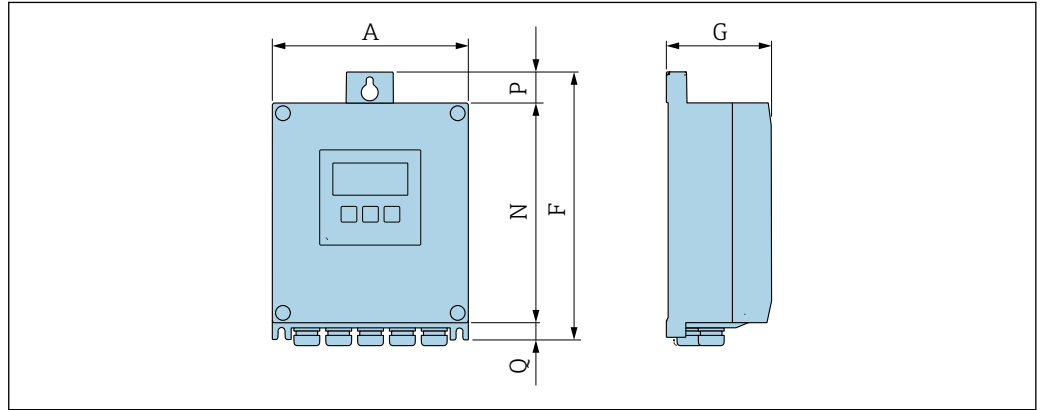

A0033789

Order code for "Transmitter housing", option A "Aluminum, coated" and order code for "Integrated ISEM electronics", option A "Sensor"

A [in]	F [in]	G [in]	N [in]	P [in]	Q [in]
6.57	9.13	3.15	7.36	0.94	0.83

Order code for "Transmitter housing", option D "Polycarbonate" and order code for "Integrated ISEM electronics", option A "Sensor"

A [in]	F [in]	G [in]	N [in]	P [in]	Q [in]
6.97	9.21	3.54	7.76	0.67	0.87

Sensor connection housing

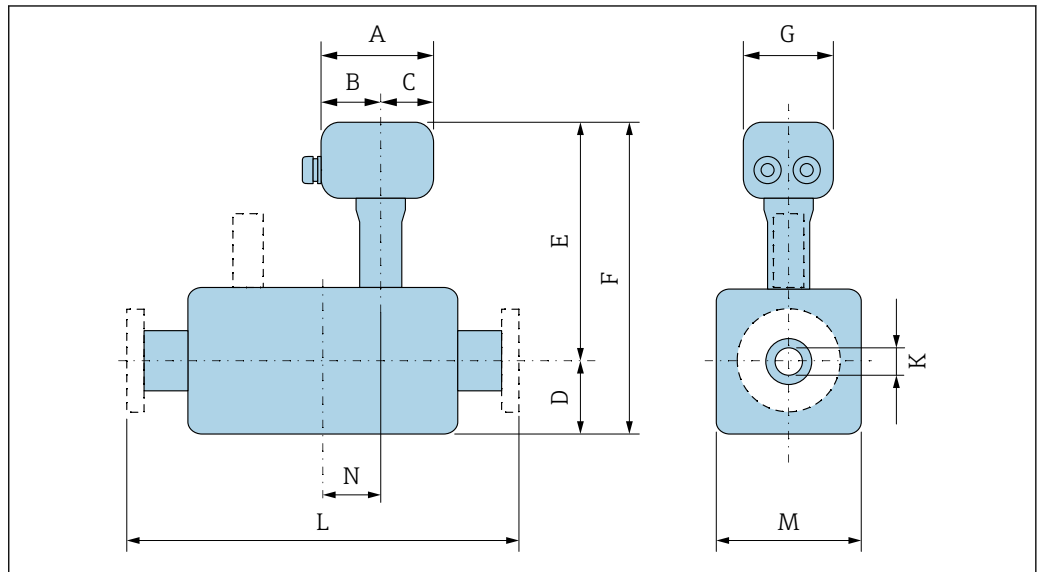

A0038135

Order code for "Sensor connection housing", option A "Aluminum, coated"

DN	A ¹⁾	B ¹⁾	C	D	E	F	G	K	L	M	N
[in]	[in]	[in]	[in]	[in]	[in]	[in]	[in]	[in]	[in]	[in]	[in]
1	5.83	3.70	2.13	0.79	13.3	14.1	5.35	0.96	²⁾	5.63	1.85
2	5.83	3.70	2.13	1.26	13.8	15.0	5.35	1.94	²⁾	8.86	2.48
3	5.83	3.70	2.13	1.73	14.3	16.0	5.35	2.90	²⁾	9.65	2.17
4	5.83	3.70	2.13	2.24	14.6	16.9	5.35	3.83	²⁾	10.4	2.83
6	5.83	3.70	2.13	3.31	15.6	18.9	5.35	5.76	²⁾	12.1	2.44
8	5.83	3.70	2.13	4.33	16.7	21.0	5.35	7.63	²⁾	13.7	3.07
10	5.83	3.70	2.13	5.43	17.7	23.2	5.35	9.56	²⁾	15.4	3.31
12	5.83	3.70	2.13	6.42	18.7	25.2	5.35	11.4	²⁾	16.9	3.78

- 1) Depending on the cable gland used: values up to + 1.18 in
- 2) Depends on the process connection in question → 55

Order code for "Sensor connection housing", option L "Cast, stainless"

DN	A ¹⁾	B ¹⁾	C	D	E	F	G	K	L	M	N
[in]	[in]	[in]	[in]	[in]	[in]	[in]	[in]	[in]	[in]	[in]	[in]
1	5.71	3.39	2.32	0.79	13.2	13.9	5.35	0.96	²⁾	5.63	1.85
2	5.71	3.39	2.32	1.26	13.6	14.9	5.35	1.94	²⁾	8.86	2.48
3	5.71	3.39	2.32	1.73	14.1	15.9	5.35	2.90	²⁾	9.65	2.17
4	5.71	3.39	2.32	2.24	14.5	16.7	5.35	3.83	²⁾	10.4	2.83
6	5.71	3.39	2.32	3.31	15.5	18.8	5.35	5.76	²⁾	12.1	2.44
8	5.71	3.39	2.32	4.33	16.5	20.9	5.35	7.63	²⁾	13.7	3.07
10	5.71	3.39	2.32	5.43	17.6	23.0	5.35	9.56	²⁾	15.4	3.31
12	5.71	3.39	2.32	6.42	18.6	25.0	5.35	11.4	²⁾	16.9	3.78

- 1) Depending on the cable gland used: values up to +1.18 in
- 2) Depends on the process connection in question → 55

Pressure measuring cell

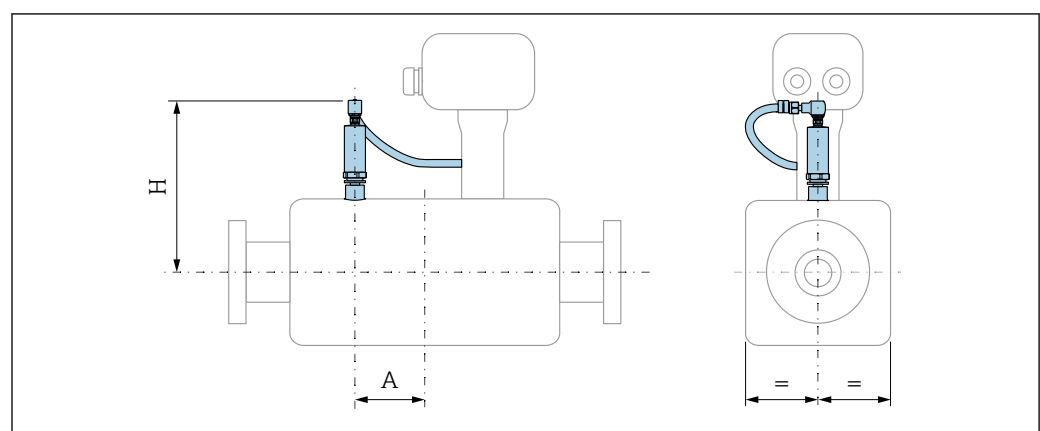

A0038137

Order code for "Pressure component": Options B/C/D/E/F "Pressure measuring cell 29/58/145/580/1450 psia"		
DN [in]	A [in]	B [in]
1	2.40	6.77
2	2.99	7.36
3	3.78	7.91
4	3.35	8.39
6	2.91	9.45
8	3.43	10.6
10	4.02	11.8
12	4.33	12.8

Flange connections

Welding neck flange ASME B16.5

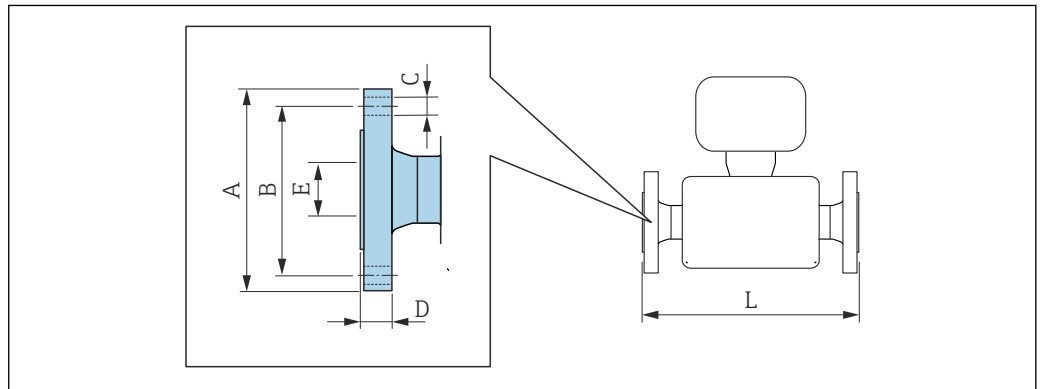

A0015621

- i** Length tolerance for dimension L in inch:
- DN ≤ 4": +0.06 / -0.08
 - DN ≥ 5": +0.14

Flange according to ASME B16.5: Class 150 RF Schedule 40 1.4404 (316, 316L): Order code for "Process connection", option AAS						
DN [in]	A [in]	B [in]	C [in]	D [in]	E [in]	L [in]
1	3.50	2.38	4 × Ø0.62	0.56	1.05	11.8
2	6.00	4.75	4 × Ø0.75	0.75	2.07	13.7
3	7.50	6.00	4 × Ø0.75	0.94	3.07	15.7
4	9.00	7.50	8 × Ø0.75	0.96	4.03	15.7
6	11.0	9.50	8 × Ø0.88	1.00	6.07	15.7
8	13.6	11.8	8 × Ø0.88	1.14	7.98	18.8
10	15.9	14.3	12 × Ø1.00	1.20	10.0	20.1
12	19.1	17.0	12 × Ø1.00	1.27	11.9	22.4

Surface roughness (flange): Ra 125 to 250 µin

Flange according to ASME B16.5: Class 300 RF Schedule 40 1.4404 (316, 316L): Order code for "Process connection", option ABS						
DN [in]	A [in]	B [in]	C [in]	D [in]	E [in]	L [in]
1	3.75	2.62	4 × Ø0.75	0.69	1.04	11.8
2	6.50	5.00	8 × Ø0.75	0.88	2.07	13.7
3	8.25	6.62	8 × Ø0.88	1.12	3.07	15.7
4	10.0	7.88	8 × Ø0.88	1.25	4.03	15.7
6	12.5	10.6	12 × Ø0.88	1.44	6.07	15.7
8	15.0	13.0	12 × Ø1.00	1.64	7.98	19.6
10	17.5	15.3	16 × Ø1.13	1.89	10.0	21.4
12	20.5	17.8	16 × Ø1.25	2.02	11.9	23.7
Surface roughness (flange): Ra 125 to 250 µin						

Flange according to ASME B16.5: Class 300 RF Schedule 80 1.4404 (316, 316L): Order code for "Process connection", option AGS						
DN [in]	A [in]	B [in]	C [in]	D [in]	E [in]	L [in]
1	3.75	2.62	4 × Ø0.75	0.69	0.96	11.8
2	6.50	5.00	8 × Ø0.75	0.88	1.94	13.7
3	8.25	6.62	8 × Ø0.88	1.12	2.9	15.7
4	10.0	7.88	8 × Ø0.88	1.25	3.82	15.7
6	12.5	10.6	12 × Ø0.88	1.44	5.76	15.7
8	15.0	13.0	12 × Ø1.00	1.64	7.63	19.6
10	17.5	15.3	16 × Ø1.13	1.89	9.56	21.4
12	20.5	17.8	16 × Ø1.25	2.02	11.4	23.7
Surface roughness (flange): Ra 125 to 250 µin						

Flange according to ASME B16.5: Class 600 RF Schedule 80 1.4404 (316, 316L): Order code for "Process connection", option ACS						
DN [in]	A [in]	B [in]	C [in]	D [in]	E [in]	L [in]
1	3.75	2.62	4 × Ø0.75	0.96	0.96	13.0
2	6.50	5.00	8 × Ø0.75	1.28	1.94	16.0
3	8.27	6.63	8 × Ø0.87	1.53	2.90	18.3
4	10.8	8.50	8 × Ø1.00	1.78	3.82	18.9
6	14.0	11.5	12 × Ø1.13	2.15	5.76	19.3
8	16.5	13.8	12 × Ø1.25	2.46	7.63	21.8
10	20.1	17.0	16 × Ø1.38	2.78	9.56	24.6
12	22.1	19.3	16 × Ø1.38	2.90	11.4	26.2
Surface roughness (flange): Ra 125 to 250 µin						

Accessories

Protective cover

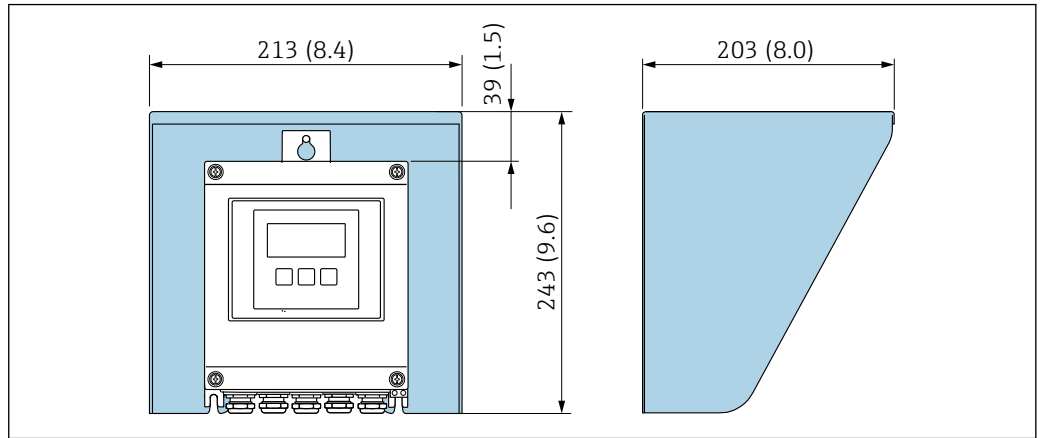

▣ 28 Weather protection cover for Proline 500 – digital

External WLAN antenna

i The external WLAN antenna is not suitable for use in hygienic applications.

Proline 500 – digital

External WLAN antenna mounted on device

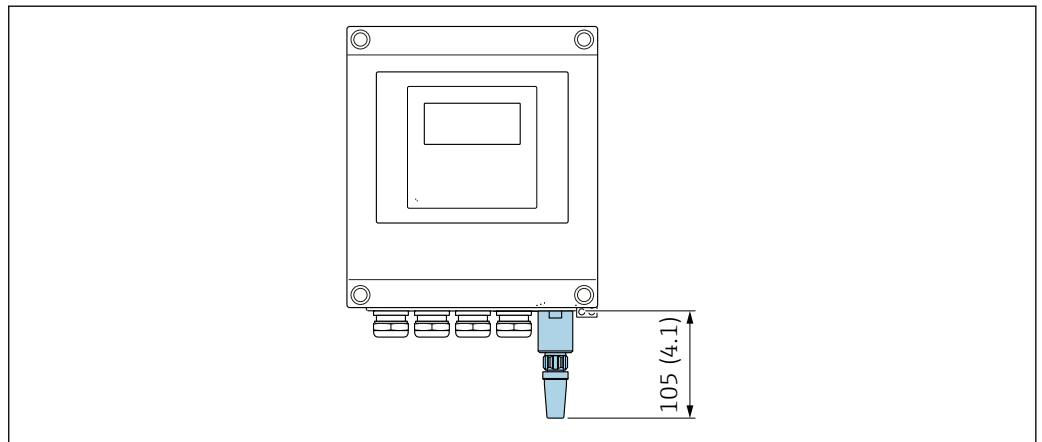

▣ 29 Engineering unit mm (in)

External WLAN antenna mounted with cable

The external WLAN antenna can be mounted separately from the transmitter if the transmission/reception conditions at the transmitter mounting location are poor.

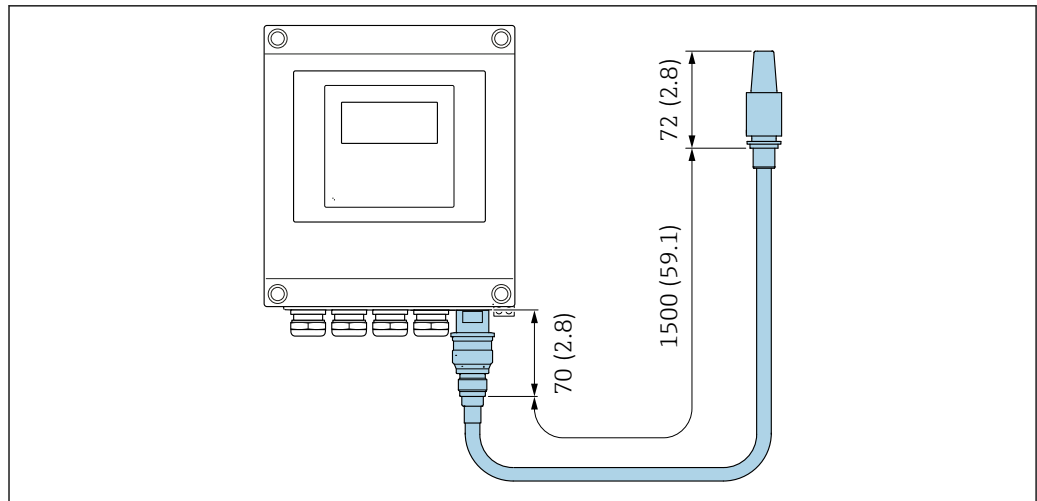

30 Engineering unit mm (in)

Weight

Transmitter

- Proline 500 – digital polycarbonate: 1.4 kg (3.1 lbs)
- Proline 500 – digital aluminum: 2.4 kg (5.3 lbs)

Sensor

- Sensor with aluminum connection housing version: see the information in the following table
- Sensor with cast connection housing version, stainless: +3.7 kg (+8.2 lbs)

Weight in SI units

Nominal diameter		EN (DIN) [kg]			
[mm]	[in]	Pressure rating			
		PN 16	PN 40	PN 63	PN 100
25	1	10	10	12	12
50	2	15	15	19	21
80	3	21	21	25	29
100	4	23	26	32	39
150	6	35	42	62	76
200	8	51	71	98	128
250	10	77	114	143	206
300	12	107	161	201	297

Nominal diameter		ASME [kg]			
[mm]	[in]	Pressure rating			
		Class 150 RF Sch.40	Class 300 RF Sch.40	Class 300 RF Sch.80	Class 600 RF Sch.80
25	1	9	10	10	11
50	2	14	16	16	18
80	3	21	24	24	28
100	4	27	35	35	49
150	6	39	55	56	89
200	8	66	91	93	136
250	10	93	133	133	222
300	12	142	193	198	278

Weight in US units

Nominal diameter		ASME [lbs]			
		Pressure rating			
[mm]	[in]	Class 150 RF Sch.40	Class 300 RF Sch.40	Class 300 RF Sch.80	Class 600 RF Sch.80
25	1	20	22	22	24
50	2	31	35	35	40
80	3	46	53	53	62
100	4	60	77	77	108
150	6	86	121	123	196
200	8	146	201	205	300
250	10	205	293	293	490
300	12	313	426	437	613

Materials



All the metal materials used meet the standards NACE MR0175 and NACE MR0103.

The seal material is tested according to NACE TM0297, NACE TM0187, NORSOK M710-B, ISO 10423 (API 6A) and ISO 23936.



The ultrasonic transducer may not be leak-tight!

Toxic and/or explosive gases may escape!

- ▶ The material of the seal is not suitable for applications in pure steam.
- ▶ The material of the seal may not be exposed to a pressure increase at low process temperatures below -40 °C (-40 °F).

Transmitter housing

Housing of Proline 500 – digital transmitter

Order code for "Transmitter housing":

- Option **A** "Aluminum coated": aluminum, AlSi10Mg, coated
- Option **D** "Polycarbonate": polycarbonate

Window material

Order code for "Transmitter housing":

- Option **A** "Aluminum, coated": glass
- Option **D** "Polycarbonate": plastic

Sensor connection housing

Order code for "Sensor connection housing":

- Option **A** "Aluminum coated": aluminum, AlSi10Mg, coated
- Option **L** "Cast, stainless": 1.4409 (CF3M) similar to 316L

Cable entries/cable glands

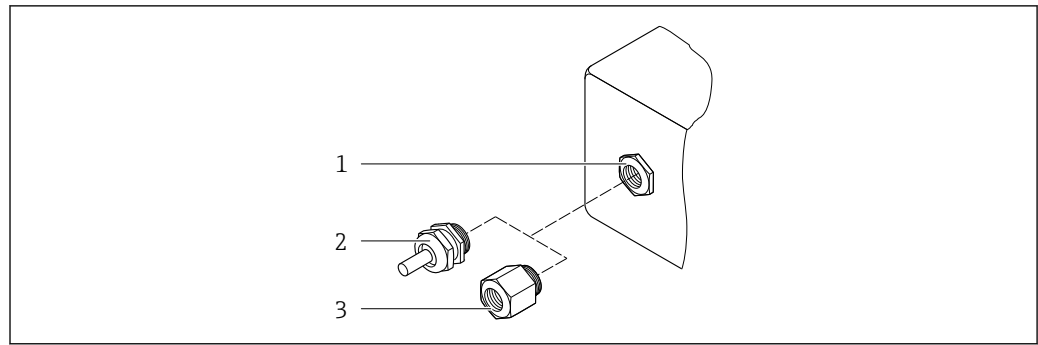

A0020640

31 Possible cable entries/cable glands

- 1 Female thread M20 × 1.5
- 2 Cable gland M20 × 1.5
- 3 Adapter for cable entry with internal thread G ½" or NPT ½"

Cable entries and adapters	Material
Cable gland M20 × 1.5	Plastic
<ul style="list-style-type: none"> ▪ Adapter for cable entry with internal thread G ½" ▪ Adapter for cable entry with internal thread NPT ½" <p>i Only available for certain device versions:</p> <ul style="list-style-type: none"> ▪ Order code for "Transmitter housing": <ul style="list-style-type: none"> ▪ Option A "Aluminum, coated" ▪ Option D "Polycarbonate" ▪ Order code for "Sensor connection housing": <ul style="list-style-type: none"> Proline 500 – digital: Option A "Aluminum coated" Option L "Cast, stainless" 	Nickel-plated brass

Connecting cable

i UV rays can impair the cable outer sheath. Protect the cable from exposure to sun as much as possible.

Connecting cable for sensor - Proline 500 – digital transmitter

PVC cable with copper shield

Measuring tube

Stainless steel: 1.4408/1.4409 (CF3M)

Process connections

Stainless steel: 1.4404 (316, 316L)

i Available process connections → 61

Cable for transmitter neck/ultrasonic transducer

Including connections for transmitter neck and ultrasonic transducer

Stainless steel: 1.4404 (316, 316L)

Ultrasonic transducer

Grade 2 titanium

Sensor holder: stainless steel: 1.4404 (316, 316L)

Seal for ultrasonic transducer

FKM material group

Temperature sensor

Stainless steel: 1.4404 (316, 316L)

Seal for temperature sensor

Seal-free (self-sealing NPT thread with sealant)

Pressure measuring cell

Stainless steel: 1.4404 (316, 316L)

Seal for pressure measuring cell

Seal-free (self-sealing NPT thread with sealant)

Accessories

Protective cover

Stainless steel, 1.4404 (316L)

External WLAN antenna

- Antenna: ASA plastic (acrylic ester-styrene-acrylonitrile) and nickel-plated brass
- Adapter: Stainless steel and nickel-plated brass
- Cable: Polyethylene
- Plug: Nickel-plated brass
- Angle bracket: Stainless steel

Process connections

Flanges:

- EN 1092-1-B1
- ASME B16.5



For information on the different materials used in the process connections → 60

Human interface

Operating concept

Operator-oriented menu structure for user-specific tasks

- Commissioning
- Operation
- Diagnostics
- Expert level

Fast and safe commissioning

- Guided menus ("Make-it-run" wizards) for applications
- Menu guidance with brief descriptions of the individual parameter functions
- Access to the device via Web server → 74
- WLAN access to the device via mobile handheld terminal, tablet or smart phone

Reliable operation

- Operation in local language → 62
- Uniform operating philosophy applied to device and operating tools
- If replacing electronic modules, transfer the device configuration via the integrated memory (HistoROM backup) which contains the process and measuring device data and the event logbook. No need to reconfigure.

Efficient diagnostics increase measurement availability

- Troubleshooting measures can be called up via the device and in the operating tools
- Diverse simulation options, logbook for events that occur and optional line recorder functions

Languages

Can be operated in the following languages:

- Via local operation
 - English, German, French, Spanish, Italian, Dutch, Portuguese, Polish, Russian, Turkish, Chinese, Japanese, Korean, Bahasa (Indonesian), Vietnamese, Czech, Swedish
- Via Web browser
 - English, German, French, Spanish, Italian, Dutch, Portuguese, Polish, Russian, Turkish, Chinese, Japanese, Korean, Bahasa (Indonesian), Vietnamese, Czech, Swedish
- Via "FieldCare", "DeviceCare" operating tool: English, German, French, Spanish, Italian, Chinese, Japanese

Local operation**Via display module**

Equipment:

- Order code for "Display; operation", option F "4-line, illuminated, graphic display; touch control"
- Order code for "Display; operation", option G "4-line, illuminated, graphic display; touch control + WLAN"

 Information about WLAN interface →  64

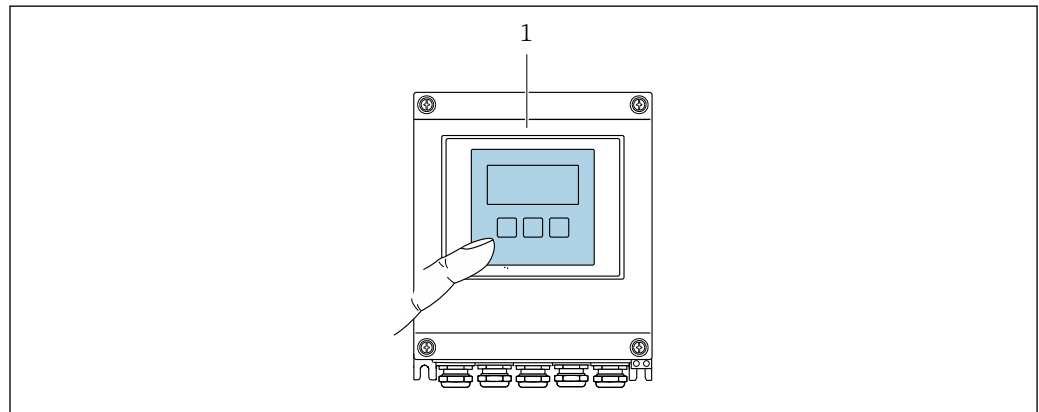



 32 Operation with touch control

1 Proline 500 – digital

Display elements

- 4-line, illuminated, graphic display
- White background lighting; switches to red in event of device errors
- Format for displaying measured variables and status variables can be individually configured
- Permitted ambient temperature for the display: -20 to $+60$ °C (-4 to $+140$ °F)
The readability of the display may be impaired at temperatures outside the temperature range.

Operating elements

- External operation via touch control (3 optical keys) without opening the housing: , , 
- Operating elements also accessible in the various zones of the hazardous area

Remote operation**Via HART protocol**

This communication interface is available in device versions with a HART output.

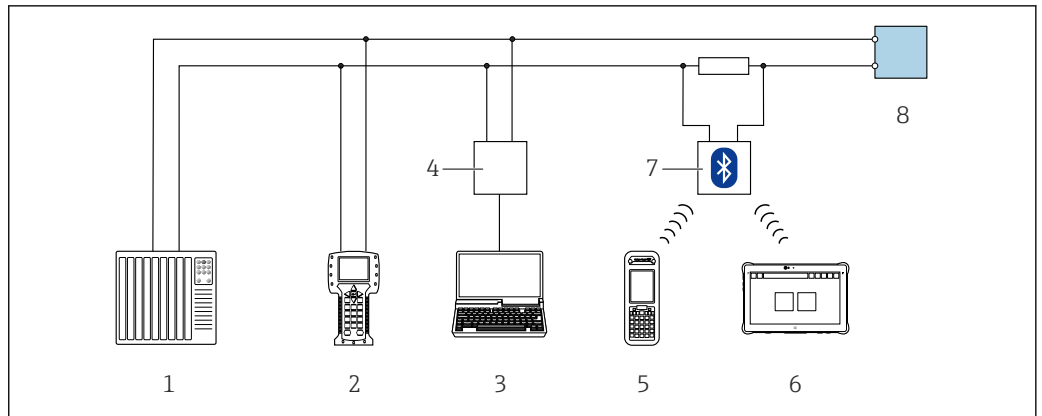

A0028747

33 Options for remote operation via HART protocol (active)

- 1 Control system (e.g. PLC)
- 2 Field Communicator 475
- 3 Computer with Web browser (e.g. Internet Explorer) for access to the integrated device Web server or computer with an operating tool (e.g. FieldCare, DeviceCare, AMS Device Manager, SIMATIC PDM) with COM DTM "CDI Communication TCP/IP"
- 4 Commubox FXA195 (USB)
- 5 Field Xpert SFX350 or SFX370
- 6 Field Xpert SMT70
- 7 VIATOR Bluetooth modem with connecting cable
- 8 Transmitter

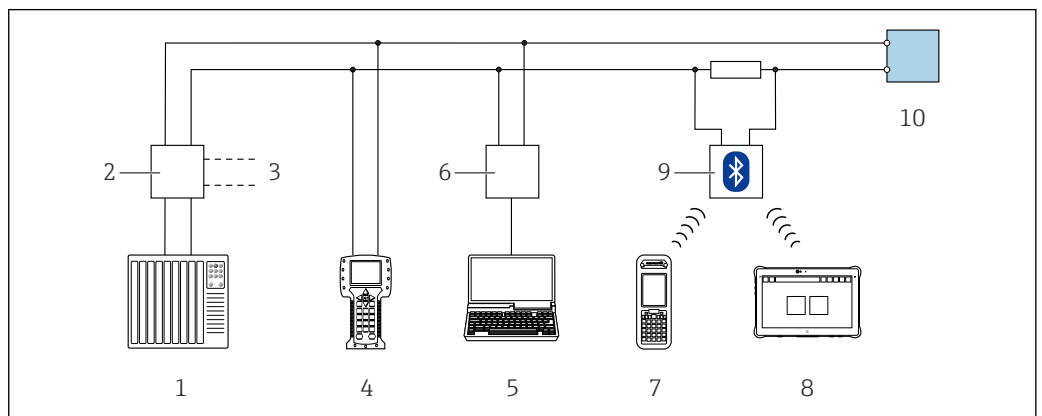

A0028746

34 Options for remote operation via HART protocol (passive)

- 1 Control system (e.g. PLC)
- 2 Transmitter power supply unit, e.g. RN221N (with communication resistor)
- 3 Connection for Commubox FXA195 and Field Communicator 475
- 4 Field Communicator 475
- 5 Computer with Web browser (e.g. Internet Explorer) for access to the integrated device Web server or computer with an operating tool (e.g. FieldCare, DeviceCare, AMS Device Manager, SIMATIC PDM) with COM DTM "CDI Communication TCP/IP"
- 6 Commubox FXA195 (USB)
- 7 Field Xpert SFX350 or SFX370
- 8 Field Xpert SMT70
- 9 VIATOR Bluetooth modem with connecting cable
- 10 Transmitter

Via Modbus RS485 protocol

This communication interface is available in device versions with a Modbus-RS485 output.

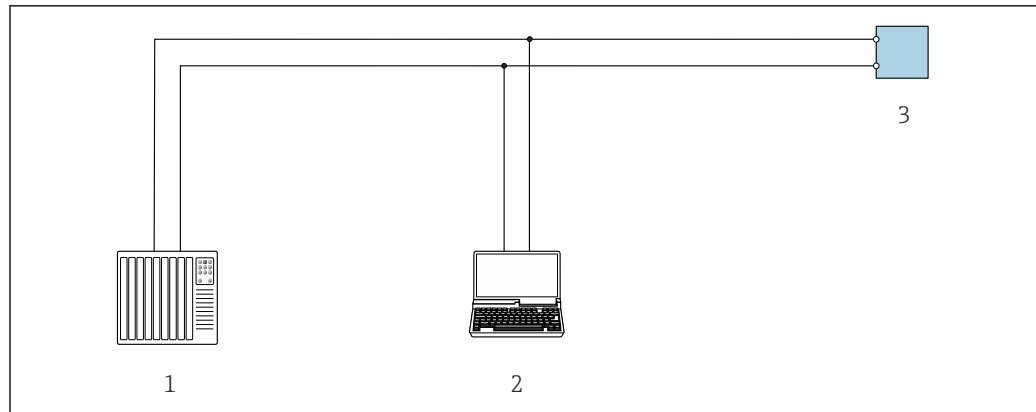

A0029437

35 Options for remote operation via Modbus-RS485 protocol (active)

- 1 Control system (e.g. PLC)
- 2 Computer with Web browser (e.g. Internet Explorer) for accessing the integrated device Web server or with operating tool (e.g. FieldCare, DeviceCare) with COM DTM "CDI Communication TCP/IP" or Modbus DTM
- 3 Transmitter

Service interface

Via service interface (CDI-RJ45)

A point-to-point connection can be established to configure the device onsite. With the housing open, the connection is established directly via the service interface (CDI-RJ45) of the device.

i An adapter for RJ45 and the M12 connector is optionally available:
Order code for "Accessories", option **NB**: "Adapter RJ45 M12 (service interface)"

The adapter connects the service interface (CDI-RJ45) to an M12 connector mounted in the cable entry. Therefore the connection to the service interface can be established via an M12 connector without opening the device.

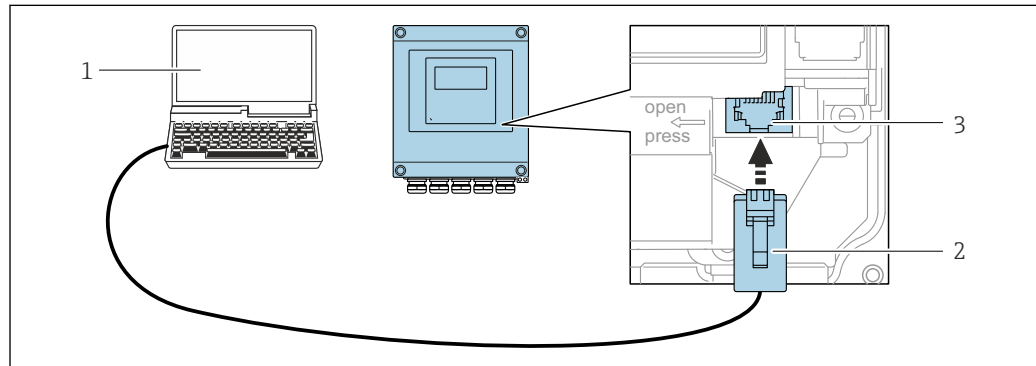

A0029163

36 Connection via service interface (CDI-RJ45)

- 1 Computer with Web browser (e.g. Microsoft Internet Explorer, Microsoft Edge) for accessing the integrated device Web server or with "FieldCare", "DeviceCare" operating tool with COM DTM "CDI Communication TCP/IP" or Modbus DTM
- 2 Standard Ethernet connecting cable with RJ45 connector
- 3 Service interface (CDI-RJ45) of the measuring device with access to the integrated Web server

Via WLAN interface

The optional WLAN interface is available on the following device version:

Order code for "Display; operation", option G "4-line, illuminated; touch control + WLAN"

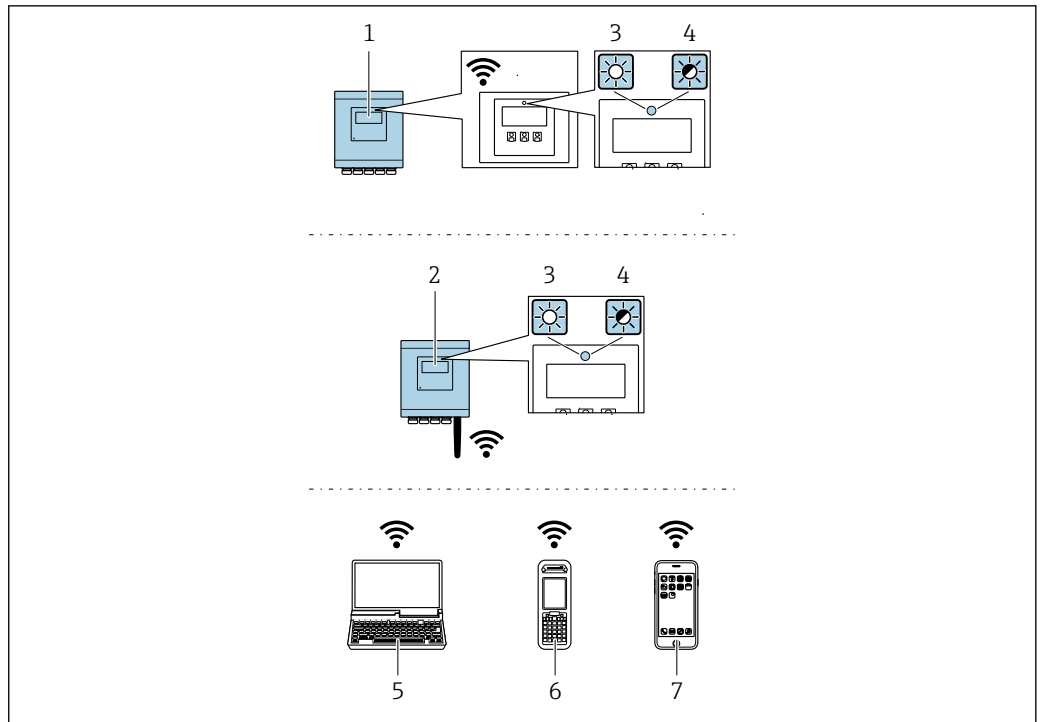



A0037682

- 1 Transmitter with integrated WLAN antenna
- 2 Transmitter with external WLAN antenna
- 3 LED lit constantly: WLAN reception is enabled on measuring device
- 4 LED flashing: WLAN connection established between operating unit and measuring device
- 5 Computer with WLAN interface and Web browser (e.g. Microsoft Internet Explorer, Microsoft Edge) for accessing the integrated device Web server or with operating tool (e.g. FieldCare, DeviceCare)
- 6 Mobile handheld terminal with WLAN interface and Web browser (e.g. Microsoft Internet Explorer, Microsoft Edge) for accessing the integrated device Web server or operating tool (e.g. FieldCare, DeviceCare)
- 7 Smart phone or tablet (e.g. Field Xpert SMT70)

Function	WLAN: IEEE 802.11 b/g (2.4 GHz) <ul style="list-style-type: none"> ▪ Access point with DHCP server (default setting) ▪ Network
Encryption	WPA2-PSK AES-128 (in accordance with IEEE 802.11i)
Configurable WLAN channels	1 to 11
Degree of protection	IP67
Available antennas	<ul style="list-style-type: none"> ▪ Internal antenna ▪ External antenna (optional) In the event of poor transmission/reception conditions at the place of installation. Available as an accessory → 72.  Only one antenna active in each case!
Range	<ul style="list-style-type: none"> ▪ Internal antenna: typically 10 m (32 ft) ▪ External antenna: typically 50 m (164 ft)
Materials (external antenna)	<ul style="list-style-type: none"> ▪ Antenna: ASA plastic (acrylic ester-styrene-acrylonitrile) and nickel-plated brass ▪ Adapter: Stainless steel and nickel-plated brass ▪ Cable: Polyethylene ▪ Connector: Nickel-plated brass ▪ Angle bracket: Stainless steel

Supported operating tools

Different operating tools can be used for local or remote access to the measuring device. Depending on the operating tool used, access is possible with different operating units and via a variety of interfaces.

Supported operating tools	Operating unit	Interface	Additional information
Web browser	Notebook, PC or tablet with Web browser	<ul style="list-style-type: none"> ■ CDI-RJ45 service interface ■ WLAN interface 	Special Documentation for device
DeviceCare SFE100	Notebook, PC or tablet with Microsoft Windows system	<ul style="list-style-type: none"> ■ CDI-RJ45 service interface ■ WLAN interface ■ Fieldbus protocol 	→  74
FieldCare SFE500	Notebook, PC or tablet with Microsoft Windows system	<ul style="list-style-type: none"> ■ CDI-RJ45 service interface ■ WLAN interface ■ Fieldbus protocol 	→  74
Device Xpert	Field Xpert SFX 100/350/370	HART and FOUNDATION Fieldbus fieldbus protocol	Operating Instructions BA01202S Device description files: Use update function of handheld terminal

 Other operating tools based on FDT technology with a device driver such as DTM/iDTM or DD/EDD can be used for device operation. These operating tools are available from the individual manufacturers. Integration into the following operating tools, among others, is supported:

- FactoryTalk AssetCentre (FTAC) by Rockwell Automation → www.rockwellautomation.com
- Process Device Manager (PDM) by Siemens → www.siemens.com
- Asset Management Solutions (AMS) by Emerson → www.emersonprocess.com
- FieldCommunicator 375/475 by Emerson → www.emersonprocess.com
- Field Device Manager (FDM) by Honeywell → www.honeywellprocess.com
- FieldMate by Yokogawa → www.yokogawa.com
- PACTWare → www.pactware.com

The associated device description files are available at: www.endress.com → Downloads

Web server

Thanks to the integrated Web server, the device can be operated and configured via a Web browser and via a service interface (CDI-RJ45) or via a WLAN interface. The structure of the operating menu is the same as for the local display. In addition to the measured values, status information on the device is also displayed and allows the user to monitor the status of the device. Furthermore the device data can be managed and the network parameters can be configured.

A device that has a WLAN interface (can be ordered as an option) is required for the WLAN connection: order code for "Display; operation", option G "4-line, illuminated; touch control + WLAN". The device acts as an Access Point and enables communication by computer or a mobile handheld terminal.

Supported functions

Data exchange between the operating unit (such as a notebook for example) and the measuring device:

- Upload the configuration from the measuring device (XML format, configuration backup)
- Save the configuration to the measuring device (XML format, restore configuration)
- Export event list (.csv file)
- Export parameter settings (.csv file or PDF file, document the measuring point configuration)
- Export the Heartbeat verification log (PDF file, only available with the "Heartbeat Verification" application package)
- Flash firmware version for device firmware upgrade, for instance
- Download driver for system integration
- Visualize up to 1000 saved measured values (only available with the **Extended HistorOM** application package →  71)

 Web server special documentation →  75

HistoROM data management The measuring device features HistoROM data management. HistoROM data management comprises both the storage and import/export of key device and process data, making operation and servicing far more reliable, secure and efficient.

 When the device is delivered, the factory settings of the configuration data are stored as a backup in the device memory. This memory can be overwritten with an updated data record, for example after commissioning.

Additional information on the data storage concept

There are different types of data storage units in which device data are stored and used by the device:

	Device memory	T-DAT	S-DAT
Available data	<ul style="list-style-type: none"> ▪ Event logbook such as diagnostic events for example ▪ Parameter data record backup ▪ Device firmware package 	<ul style="list-style-type: none"> ▪ Measured value logging ("Extended HistoROM" order option) ▪ Current parameter data record (used by firmware at run time) ▪ Peakhold indicator (min/max values) ▪ Totalizer values 	<ul style="list-style-type: none"> ▪ Sensor data: nominal diameter etc. ▪ Serial number ▪ Calibration data ▪ Device configuration (e.g. SW options, fixed I/O or multi I/O)
Storage location	Fixed on the user interface board in the connection compartment	Attachable to the user interface board in the connection compartment	In the sensor plug in the transmitter neck part

Data backup

Automatic

- The most important device data (sensor and transmitter) are automatically saved in the DAT modules
- If the transmitter or measuring device is replaced: once the T-DAT containing the previous device data has been exchanged, the new measuring device is ready for operation again immediately without any errors
- If the sensor is replaced: once the sensor has been replaced, new sensor data are transferred from the S-DAT in the measuring device and the measuring device is ready for operation again immediately without any errors
- If exchanging the electronics module (e.g. I/O electronics module): Once the electronics module has been replaced, the software of the module is compared against the current device firmware. The module software is upgraded or downgraded where necessary. The electronics module is available for use immediately afterwards and no compatibility problems occur.

Manual

Additional parameter data record (complete parameter settings) in the integrated device memory HistoROM backup for:

- Data backup function
Backup and subsequent restoration of a device configuration in the device memory HistoROM backup
- Data comparison function
Comparison of the current device configuration with the device configuration saved in the device memory HistoROM backup

Data transfer

Manual

Transfer of a device configuration to another device using the export function of the specific operating tool, e.g. with FieldCare, DeviceCare or Web server: to duplicate the configuration or to store in an archive (e.g. for backup purposes)

Event list

Automatic

- Chronological display of up to 20 event messages in the events list
- If the **Extended HistoROM** application package (order option) is enabled: up to 100 event messages are displayed in the events list along with a time stamp, plain text description and remedial measures
- The events list can be exported and displayed via a variety of interfaces and operating tools e.g. DeviceCare, FieldCare or Web server

Data logging**Manual**

If the **Extended HistoROM** application package (order option) is enabled:

- Record up to 1 000 measured values via 1 to 4 channels
- User configurable recording interval
- Record up to 250 measured values via each of the 4 memory channels
- Export the measured value log via a variety of interfaces and operating tools e.g. FieldCare, DeviceCare or web server

Certificates and approvals

Currently available certificates and approvals can be called up via the product configurator.

CE mark	The device meets the legal requirements of the applicable EU Directives. These are listed in the corresponding EU Declaration of Conformity along with the standards applied. Endress+Hauser confirms successful testing of the device by affixing to it the CE mark.
RCM-tick symbol	The measuring system meets the EMC requirements of the "Australian Communications and Media Authority (ACMA)".
Ex approval	The measuring device is certified for use in hazardous areas and the relevant safety instructions are provided in the separate "Safety Instructions" (XA) document. Reference is made to this document on the nameplate. The separate Ex documentation (XA) containing all the relevant explosion protection data is available from your Endress+Hauser sales center.

Proline 500 – digital*ATEX/IECEX*

Currently, the following versions for use in hazardous areas are available:

Ex db ia

Transmitter		Sensor	
Category	Type of protection	Category	Type of protection
–	–	II2G	Ex db ia IIC T6...T1 Gb
II3G	Ex ec nC IIC T5...T4 Gc	II2G	Ex db ia IIC T6...T1 Gb

Ex ec

Transmitter		Sensor	
Category	Type of protection	Category	Type of protection
–	–	II3G	Ex ec ic IIC
II3G	Ex ec nC IIC T5...T4 Gc	II3G	Ex ec ic IIC

Ex tb

Transmitter		Sensor	
Category	Type of protection	Category	Type of protection
–	–	II2D	Ex ia tb IIIC T** °C Db

cCSA_{US}

Currently, the following versions for use in hazardous areas are available:

IS

Transmitter	Sensor
Class I Division 2 Groups A - D	Class I, II, III Division 1 Groups A-G

NI

Transmitter	Sensor
Class I Division 2 Groups A - D	Class I Division 2 Groups A - D

Ex i

Transmitter	Sensor
Class I Zone 2, AEx/Ex nA nC IIC T5...T4 Gc	Class I Zone 1, AEx/Ex d ia IIC T6...T1 Gb

Ex nA

Transmitter	Sensor
Class I Zone 2, AEx/Ex nA nC IIC T5...T4 Gc	Class I Zone 2, AEx/Ex nA ic IIC T6...T1 Gc

Ex tb

Transmitter	Sensor
-	Zone 21, AEx/Ex ia tb IIC T** °C Db

Functional safety

The measuring device can be used for flow monitoring systems (min., max., range) up to SIL 2 (single-channel architecture; order code for "Additional approval", option LA) and SIL 3 (multichannel architecture with homogeneous redundancy) and is independently evaluated and certified by the TÜV in accordance with IEC 61508.

The following types of monitoring in safety equipment are possible:

 Functional Safety Manual with information on the SIL device

HART certification

HART interface

The measuring device is certified and registered by the FieldComm Group. The measuring system meets all the requirements of the following specifications:

- Certified according to HART 7
- The device can also be operated with certified devices of other manufacturers (interoperability)

Pressure Equipment Directive

The devices can be ordered with or without a PED approval. If a device with a PED approval is required, this must be explicitly stated in the order. For devices with nominal diameters less than or equal to DN 25 (1"), this is neither possible nor necessary.

- With the identification PED/G1/x (x = category) on the sensor nameplate, Endress+Hauser confirms conformity with the "Essential Safety Requirements" specified in Appendix I of the Pressure Equipment Directive 2014/68/EU.
- Devices bearing this marking (PED) are suitable for the following types of medium: Media in Group 1 and 2 with a vapor pressure greater than, or smaller and equal to 0.5 bar (7.3 psi)
- Devices not bearing this marking (PED) are designed and manufactured according to good engineering practice. They meet the requirements of Article 4 paragraph 3 of the Pressure Equipment Directive 2014/68/EU. The range of application is indicated in tables 6 to 9 in Annex II of the Pressure Equipment Directive 2014/68/EU.

Radio approval

The measuring device has radio approval.

 For detailed information regarding radio approval, see Special Documentation → 75

Additional certification**CRN approval**

Some device versions have CRN approval. A CRN-approved process connection with a CSA approval must be ordered for a CRN-approved device.

Tests and certificates

- EN10204-3.1 material certificate, parts and sensor housing in contact with medium (order code for "Test, certificate", option JA)
- Pressure testing, internal procedure, test report (order code for "Test, certificate", option JB)
- Ambient temperature $-50\text{ }^{\circ}\text{C}$ ($-58\text{ }^{\circ}\text{F}$) (order code for "Test, certificate", option JP)
- Helium leak testing, internal procedure, test report (order code for "Test, certificate", option KC)
- EN10204-2.1 confirmation of compliance with the order and EN10204-2.2 test report

Testing of welds

Order code for "Test, certificate", option	Radiographic testing standard		Process connection
	ISO 10675-1 ZG1	ASME B31.3 NFS	
KE	x		RT
KI		x	RT
K5	x		DR
K6		x	DR
RT = Radiographic testing, DR = Digital radiography All options with test report			

Other standards and guidelines

- EN 60529
Degrees of protection provided by enclosures (IP code)
- EN 61010-1
Safety requirements for electrical equipment for measurement, control and laboratory use - general requirements
- IEC/EN 61326
Emission in accordance with Class A requirements. Electromagnetic compatibility (EMC requirements).
- NAMUR NE 21
Electromagnetic compatibility (EMC) of industrial process and laboratory control equipment
- NAMUR NE 32
Data retention in the event of a power failure in field and control instruments with microprocessors
- NAMUR NE 43
Standardization of the signal level for the breakdown information of digital transmitters with analog output signal.
- NAMUR NE 53
Software of field devices and signal-processing devices with digital electronics
- NAMUR NE 105
Specifications for integrating fieldbus devices in engineering tools for field devices
- NAMUR NE 107
Self-monitoring and diagnosis of field devices
- NAMUR NE 131
Requirements for field devices for standard applications
- AGA Report No. 9
Measurement of gas by multipath ultrasonic meters.
- ISO 17089
Measurement of fluid flow in closed conduits – Ultrasonic meters for gas.

Ordering information

Detailed ordering information is available as follows:

- In the Product Configurator on the Endress+Hauser website: www.endress.com -> Click "Corporate" -> Select your country -> Click "Products" -> Select the product using the filters and search field -> Open product page -> The "Configure" button to the right of the product image opens the Product Configurator.
- From your Endress+Hauser Sales Center: www.addresses.endress.com



Product Configurator - the tool for individual product configuration

- Up-to-the-minute configuration data
- Depending on the device: Direct input of measuring point-specific information such as measuring range or operating language
- Automatic verification of exclusion criteria
- Automatic creation of the order code and its breakdown in PDF or Excel output format
- Ability to order directly in the Endress+Hauser Online Shop

Application packages

Many different application packages are available to enhance the functionality of the device. Such packages might be needed to address safety aspects or specific application requirements.

The application packages can be ordered with the device or subsequently from Endress+Hauser. Detailed information on the order code in question is available from your local Endress+Hauser sales center or on the product page of the Endress+Hauser website: www.endress.com.



Detailed information on the application packages:
Special Documentation for the device → 75

Diagnostics functions

Package	Description
Extended HistoROM	<p>Comprises extended functions concerning the event log and the activation of the measured value memory.</p> <p>Event log: Memory volume is extended from 20 message entries (standard version) to up to 100 entries.</p> <p>Data logging (line recorder):</p> <ul style="list-style-type: none"> ■ Memory capacity for up to 1000 measured values is activated. ■ 250 measured values can be output via each of the 4 memory channels. The recording interval can be defined and configured by the user. ■ Measured value logs can be accessed via the local display or operating tool e.g. FieldCare, DeviceCare or Web server.

Heartbeat Technology

Package	Description
Heartbeat Verification +Monitoring	<p>Heartbeat Verification Meets the requirement for traceable verification to DIN ISO 9001:2008 Chapter 7.6 a) "Control of monitoring and measuring equipment".</p> <ul style="list-style-type: none"> ■ Functional testing in the installed state without interrupting the process. ■ Traceable verification results on request, including a report. ■ Simple testing process via local operation or other operating interfaces. ■ Clear measuring point assessment (pass/fail) with high test coverage within the framework of manufacturer specifications. ■ Extension of calibration intervals according to operator's risk assessment. <p>Heartbeat Monitoring Continuously supplies data, which are characteristic of the measuring principle, to an external condition monitoring system for the purpose of preventive maintenance or process analysis. These data enable the operator to:</p> <ul style="list-style-type: none"> ■ Draw conclusions - using these data and other information - about the impact the measuring application has on the measuring performance over time. ■ Schedule servicing in time. ■ Monitor the process or product quality, e.g. gas pockets.

Advanced gas analysis









Package	Description
Advanced gas analysis	<p>The most important gas properties (molar mass, calorific value, Wobbe index etc.) can be calculated and displayed with the application package.</p> <p>The following gas types are available:</p> <ul style="list-style-type: none"> ▪ Single gas (known gas) ▪ Gas mixture (known composition) ▪ Coal gas/biogas (measurement of methane content) ▪ Natural gas – standardized calculation (with internationally recognized gas models: AGA NX-19, ISO 12213-2, ISO 12213-3, AGA 5, ISO 6976) ▪ Natural gas – using sound velocity (measurement of molar mass) ▪ User-specific gas (generic gas or gas mixture without knowledge of the composition of the gas) <p> The application package can only be ordered in combination with the order code for "Measuring tube; Transducer; Sensor version", option AC "316L; Titanium Gr. 2; pressure + temperature measurement integrated".</p>





Accessories

Various accessories, which can be ordered with the device or subsequently from Endress+Hauser, are available for the device. Detailed information on the order code in question is available from your local Endress+Hauser sales center or on the product page of the Endress+Hauser website: www.endress.com.







Device-specific accessories

For the transmitter



Accessories	Description
Transmitter Proline 500 – digital	<p>Transmitter for replacement or storage. Use the order code to define the following specifications:</p> <ul style="list-style-type: none"> ▪ Approvals ▪ Output ▪ Input ▪ Display/operation ▪ Housing ▪ Software <p> Proline 500 – digital transmitter: Order code: 9X5BXX-*****A</p> <p> Proline 500 transmitter for replacement: It is essential to specify the serial number of the current transmitter when ordering. Based on the serial number, the device-specific data (e.g., calibration factors) of the replacement device can be used for the new transmitter.</p> <p> Proline 500 – digital transmitter: Installation Instructions EA01264D</p>
External WLAN antenna	<p>External WLAN antenna with 1.5 m (59.1 in) connecting cable and two angle brackets. Order code for "Accessory enclosed", option P8 "Wireless antenna wide area".</p> <p> <ul style="list-style-type: none"> ▪ The external WLAN antenna is not suitable for use in hygienic applications. ▪ Further information on the WLAN interface →  64. </p> <p> Order number: 71351317</p> <p> Installation Instructions EA01238D</p>
Pipe mounting set	<p>Pipe mounting set for transmitter.</p> <p> Proline 500 – digital transmitter Order number: 71346427</p> <p> Installation Instructions EA01195D</p>

Protective cover Transmitter Proline 500 – digital	Is used to protect the measuring device from the effects of the weather: e.g. rainwater, excess heating from direct sunlight.  Proline 500 – digital transmitter Order number: 71343504  Installation Instructions EA01191D
Display guard Proline 500 – digital	Is used to protect the display against impact or scoring from sand in desert areas.  Order number: 71228792  Installation Instructions EA01093D
Connecting cable Proline 500 – digital Sensor – Transmitter	The connecting cable can be ordered directly with the measuring device (order code for "Cable, sensor connection) or as an accessory (order number DK9012). The following cable lengths are available: order code for "Cable, sensor connection" <ul style="list-style-type: none"> ▪ Option B: 20 m (65 ft) ▪ Option E: User configurable up to max. 50 m ▪ Option F: User configurable up to max. 165 ft  Maximum possible cable length for a Proline 500 – digital connecting cable: 300 m (1000 ft)

Communication-specific accessories

Accessories	Description
Commubox FXA195 HART	For intrinsically safe HART communication with FieldCare via the USB interface.  Technical Information TI00404F
HART Loop Converter HMX50	Is used to evaluate and convert dynamic HART process variables to analog current signals or limit values.  <ul style="list-style-type: none"> ▪ Technical Information TI00429F ▪ Operating Instructions BA00371F
Fieldgate FXA320	Gateway for the remote monitoring of connected 4-20 mA measuring devices via a Web browser.  Technical Information TI00025S Operating Instructions BA00053S
Fieldgate FXA520	Gateway for the remote diagnostics and remote configuration of connected HART measuring devices via a Web browser.  Technical Information TI00025S Operating Instructions BA00051S
Field Xpert SFX350	Field Xpert SFX350 is a mobile computer for commissioning and maintenance. It enables efficient device configuration and diagnostics for HART and FOUNDATION Fieldbus devices and can be used in non-hazardous areas.  Operating Instructions BA01202S
Field Xpert SFX370	Field Xpert SFX370 is a mobile computer for commissioning and maintenance. It enables efficient device configuration and diagnostics for HART and FOUNDATION Fieldbus devices and can be used in the non-hazardous area and in the hazardous area.  Operating Instructions BA01202S
Field Xpert SMT70	The Field Xpert SMT70 tablet PC for device configuration enables mobile plant asset management in hazardous and non-hazardous areas. It is suitable for commissioning and maintenance staff to manage field instruments with a digital communication interface and to record progress. This tablet PC is designed as an all-in-one solution with a preinstalled driver library and is an easy-to-use, touch-sensitive tool which can be used to manage field instruments throughout their entire life cycle.  <ul style="list-style-type: none"> ▪ Technical Information TI01342S ▪ Operating Instructions BA01709S ▪ Product page: www.endress.com/smt70

Service-specific accessories

Accessories	Description
Applicator	<p>Software for selecting and sizing Endress+Hauser measuring devices:</p> <ul style="list-style-type: none"> Choice of measuring devices for industrial requirements Calculation of all the necessary data for identifying the optimum flowmeter: e.g. nominal diameter, pressure loss, flow velocity and accuracy. Graphic illustration of the calculation results Determination of the partial order code, administration, documentation and access to all project-related data and parameters over the entire life cycle of a project. <p>Applicator is available:</p> <ul style="list-style-type: none"> Via the Internet: https://portal.endress.com/webapp/applicator As a downloadable DVD for local PC installation.
W@M	<p>W@M Life Cycle Management Improved productivity with information at your fingertips. Data relevant to a plant and its components is generated from the first stages of planning and during the asset's complete life cycle.</p> <p>W@M Life Cycle Management is an open and flexible information platform with online and on-site tools. Instant access for your staff to current, in-depth data shortens your plant's engineering time, speeds up procurement processes and increases plant uptime.</p> <p>Combined with the right services, W@M Life Cycle Management boosts productivity in every phase. For more information, visit www.endress.com/lifecyclemanagement</p>
FieldCare	<p>FDT-based plant asset management tool from Endress+Hauser. It can configure all smart field units in your system and helps you manage them. By using the status information, it is also a simple but effective way of checking their status and condition.</p> <p> Operating Instructions BA00027S and BA00059S</p>
DeviceCare	<p>Tool to connect and configure Endress+Hauser field devices.</p> <p> Innovation brochure IN01047S</p>

System components

Accessories	Description
Memograph M graphic data manager	<p>The Memograph M graphic data manager provides information on all the relevant measured variables. Measured values are recorded correctly, limit values are monitored and measuring points analyzed. The data are stored in the 256 MB internal memory and also on a SD card or USB stick.</p> <p> <ul style="list-style-type: none"> Technical Information TI00133R Operating Instructions BA00247R </p>

Supplementary documentation

-  For an overview of the scope of the associated Technical Documentation, refer to the following:
- W@M Device Viewer (www.endress.com/deviceviewer): Enter the serial number from nameplate
 - Endress+Hauser Operations App: Enter the serial number from the nameplate or scan the 2D matrix code (QR code) on the nameplate

Standard documentation

Brief Operating Instructions

Brief Operating Instructions for the sensor

Measuring device	Documentation code
Proline Prosonic Flow G	KA01374D

Brief Operating Instructions for transmitter

Measuring device	Documentation code	
	HART	Modbus RS485
Proline 500 – digital	KA01377D	KA01378D

Operating Instructions

Measuring device	Documentation code	
	HART	Modbus RS485
Prosonic Flow G 500	BA01836D	BA01837D

Description of Device Parameters

Measuring device	Documentation code	
	HART	Modbus RS485
Prosonic Flow 500	GP01132D	GP01133D

Device-dependent additional documentation

Safety instructions

Safety instructions for electrical equipment for hazardous areas.

Content	Documentation code
ATEX/IECEX Ex i	XA01850D
ATEX/IECEX Ex ec	XA01849D
cCSAus Ex i	XA01852D
cCSAus Ex ec	XA01851D
cCSAus XP	XA01853D

Special documentation

Content	Documentation code
Information on the Pressure Equipment Directive	SD01614D
Radio approvals for WLAN interface for A309/A310 display module	SD01793D

Content	Documentation code	
	HART	Modbus RS485
Advanced gas analysis	SD02351D	SD02352D
Functional Safety Manual	SD02308D	–
Heartbeat Technology	SD02304D	SD02305D
Web server	SD02311D	SD02312D

Installation Instructions

Content	Comment
Installation instructions for spare part sets and accessories	Documentation code: specified for each individual accessory .

Registered trademarks

HART®

Registered trademark of the FieldComm Group, Austin, Texas, USA

Modbus®

Registered trademark of SCHNEIDER AUTOMATION, INC.

www.addresses.endress.com
