



## Triangulation sensor (SbR) OQT150-R101-2EP-IO-IR



- Miniature design with versatile mounting options
- Multi Pixel Technology (MPT) - flexibility and adaptability
- Infrared light design
- Reduction of device variety - several switch points within one sensor
- Reliable detection of all surfaces, independent of color and structure
- Low sensitivity to target color
- IO-Link interface for service and process data

Switching diffuse mode sensor with measurement core technology, 150 mm detection range, red light, IO-Link, 2 x push-pull output, 2 m fixed cable



### Function

The miniature optical sensors are the first devices of their kind to offer an end-to-end solution in a small single standard design — from thru-beam sensor through to a distance measurement device. As a result of this design, the sensors are able to perform practically all standard automation tasks.

The DuraBeam laser sensors are durable and can be used in the same way as a standard sensor.

The use of Multi Pixel Technology gives the standard sensors a high level of flexibility and enables them to adapt more effectively to their operating environment.

### Dimensions

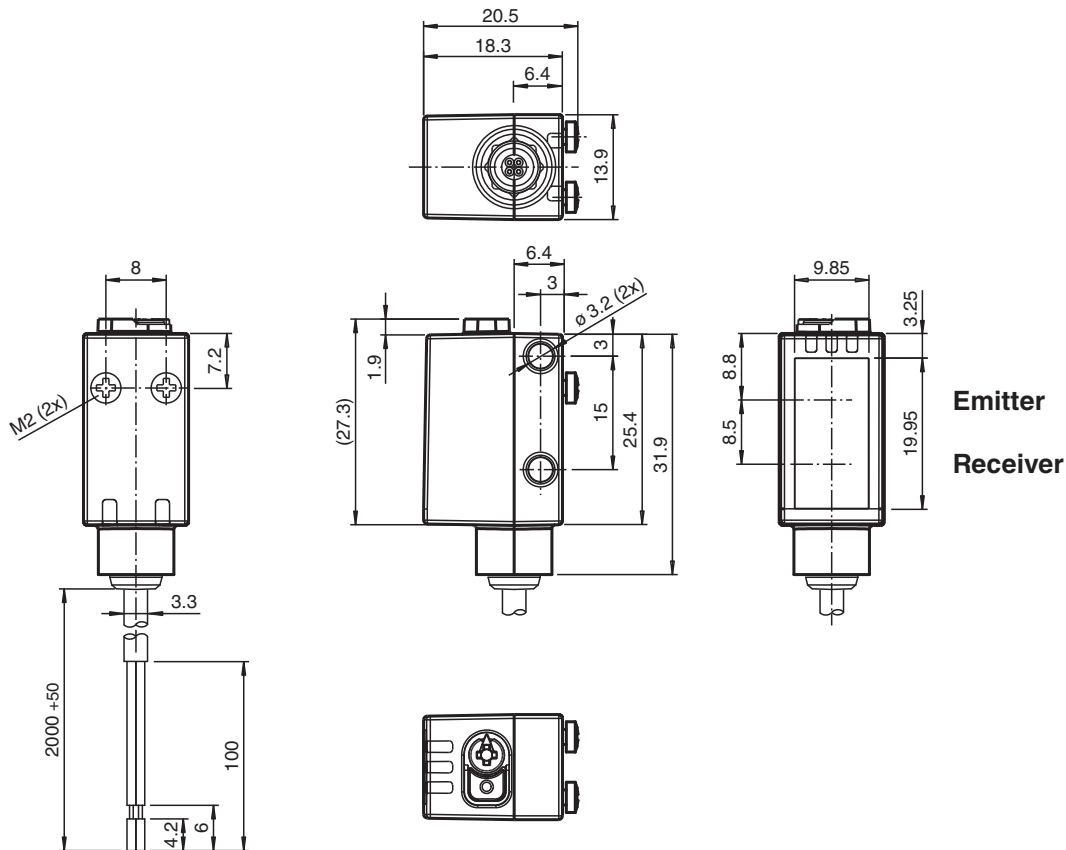

Release date: 2023-04-05 Date of issue: 2023-04-05 Filename: 267075-100441\_eng.pdf

Refer to "General Notes Relating to Pepperl+Fuchs Product Information".

Pepperl+Fuchs Group  
www.pepperl-fuchs.com

USA: +1 330 486 0001  
fa-info@us.pepperl-fuchs.com

Germany: +49 621 776 1111  
fa-info@de.pepperl-fuchs.com

Singapore: +65 6779 9091  
fa-info@sg.pepperl-fuchs.com

**PF** PEPPERL+FUCHS

## Technical Data

General specifications		
Detection range		5 ... 150 mm
Detection range min.		5 ... 20 mm
Detection range max.		5 ... 150 mm
Adjustment range		20 ... 150 mm
Reference target		standard white, 100 mm x 100 mm
Light source		LED
Light type		modulated infrared light 850 nm
LED risk group labelling		exempt group
Black-white difference (6%/90%)		< 5 % at 150 mm
Diameter of the light spot		approx. 12 mm at a distance of 150 mm
Opening angle		approx. 4.5 °
Ambient light limit		EN 60947-5-2 : 30000 Lux
Functional safety related parameters		
MTTF <sub>d</sub>		600 a
Mission Time (T <sub>M</sub> )		20 a
Diagnostic Coverage (DC)		0 %
Indicators/operating means		
Operation indicator		LED green: constantly on - power on flashing (4Hz) - short circuit flashing with short break (1 Hz) - IO-Link mode
Function indicator		LED yellow: constantly on - switch output active constantly off - switch output inactive
Control elements		Teach-In key
Control elements		5-step rotary switch for operating modes selection
Electrical specifications		
Operating voltage	U <sub>B</sub>	10 ... 30 V DC
Ripple		max. 10 %
No-load supply current	I <sub>0</sub>	< 25 mA at 24 V supply voltage
Protection class		III
Interface		
Interface type		IO-Link ( via C/Q = BK )
IO-Link revision		1.1
Device profile		Smart Sensor
Device ID		0x110807 (1116167)
Transfer rate		COM2 (38.4 kBit/s)
Min. cycle time		2.3 ms
Process data width		Process data input 2 Bit Process data output 2 Bit
SIO mode support		yes
Compatible master port type		A
Output		
Switching type		The default setting is: C/Q - BK: NPN normally open, PNP normally closed, IO-Link Q2 - WH: NPN normally open, PNP normally closed
Signal output		2 push-pull (4 in 1) outputs, short-circuit protected, reverse polarity protected, overvoltage protected
Switching voltage		max. 30 V DC
Switching current		max. 100 mA , resistive load
Usage category		DC-12 and DC-13
Voltage drop	U <sub>d</sub>	≤ 1.5 V DC
Switching frequency	f	217 Hz
Response time		2.3 ms
Conformity		

Release date: 2023-04-05 Date of issue: 2023-04-05 Filename: 267075-100441\_eng.pdf

## Technical Data

Communication interface	IEC 61131-9
Product standard	EN 60947-5-2
<b>Approvals and certificates</b>	
UL approval	E87056 , cULus Listed , class 2 power supply , type rating 1
<b>Ambient conditions</b>	
Ambient temperature	-40 ... 60 °C (-40 ... 140 °F) , fixed cable -25 ... 60 °C (-13 ... 140 °F) , movable cable not appropriate for conveyor chains
Storage temperature	-40 ... 70 °C (-40 ... 158 °F)
<b>Mechanical specifications</b>	
Housing width	13.9 mm
Housing height	33.8 mm
Housing depth	18.3 mm
Degree of protection	IP67 / IP69 / IP69K
Connection	2 m fixed cable
<b>Material</b>	
Housing	PC (Polycarbonate)
Optical face	PMMA
Mass	approx. 36 g
Cable length	2 m

## Connection

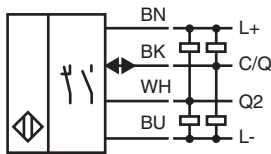

## Assembly

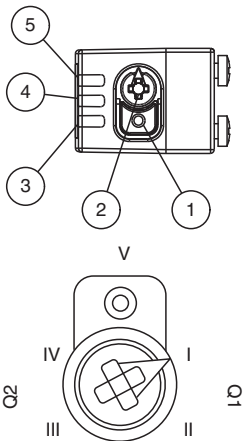

1	TEACH-IN button
2	Mode rotary switch
3	Switch output indicator Q2
4	Switch output indicator Q1
5	Operating indicator

I	Switch output 1 / switch point B
II	Switch output 1 / switch point A
III	Switch output 2 / switch point A
IV	Switch output 2 / B
V	Keylock

Release date: 2023-04-05 Date of issue: 2023-04-05 Filename: 267075-100441\_eng.pdf

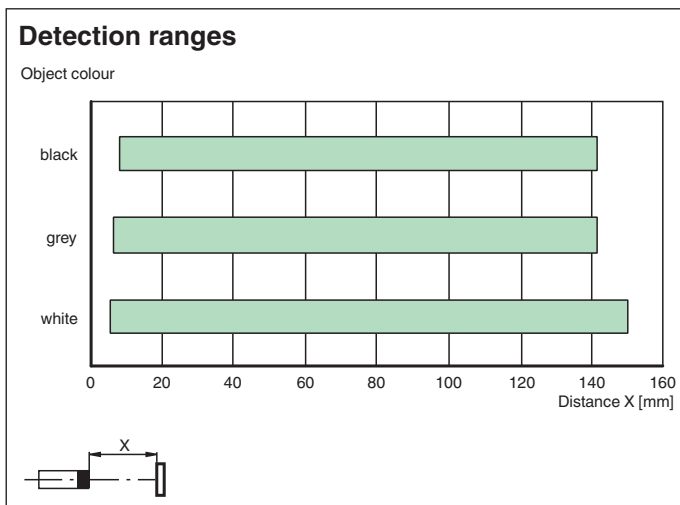
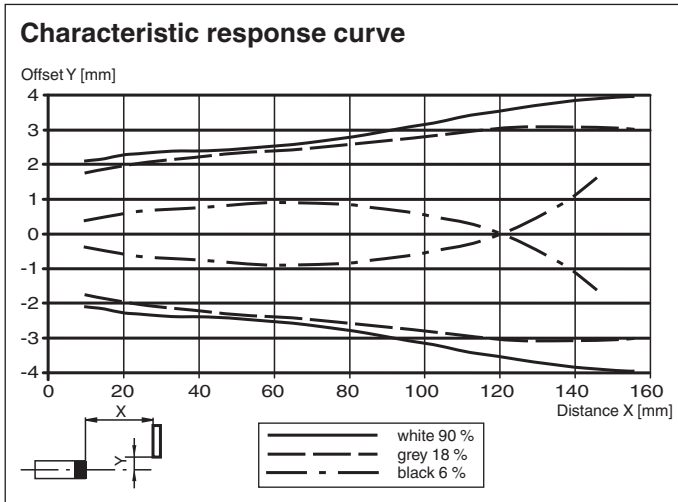

**Characteristic Curve**

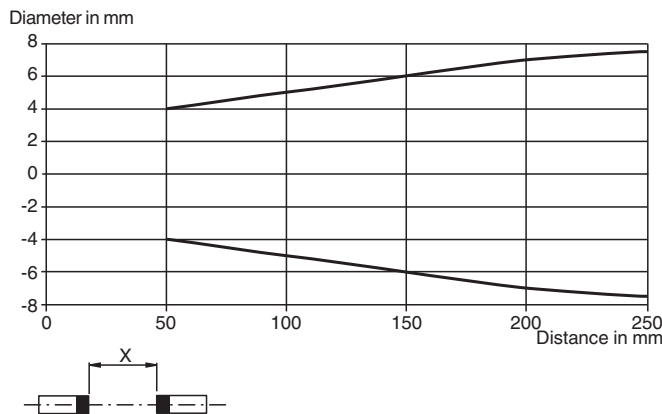

**Light spot diameter**















**Accessories**

	<b>OMH-R101</b>	Mounting Clamp
	<b>OMH-R101-Front</b>	Mounting Clamp

Release date: 2023-04-05 Date of issue: 2023-04-05 Filename: 267075-100441\_eng.pdf

Refer to "General Notes Relating to Pepperl+Fuchs Product Information".

**Accessories**

	<b>OMH-4.1</b>	Mounting Clamp
	<b>OMH-ML6</b>	Mounting bracket
	<b>OMH-ML6-U</b>	Mounting bracket
	<b>OMH-ML6-Z</b>	Mounting bracket
	<b>ICE2-8IOL-G65L-V1D</b>	EtherNet/IP IO-Link master with 8 inputs/outputs
	<b>ICE3-8IOL-G65L-V1D</b>	PROFINET IO IO-Link master with 8 inputs/outputs
	<b>ICE1-8IOL-G30L-V1D</b>	Ethernet IO-Link module with 8 inputs/outputs
	<b>ICE1-8IOL-G60L-V1D</b>	Ethernet IO-Link module with 8 inputs/outputs
	<b>ICE2-8IOL-K45P-RJ45</b>	EtherNet/IP IO-Link master with 8 inputs/outputs, DIN rail, push-in connectors
	<b>ICE2-8IOL-K45S-RJ45</b>	EtherNet/IP IO-Link master with 8 inputs/outputs, DIN rail, screw terminal
	<b>ICE3-8IOL-K45P-RJ45</b>	PROFINET IO IO-Link master with 8 inputs/outputs, DIN rail, push-in terminals
	<b>ICE3-8IOL-K45S-RJ45</b>	PROFINET IO IO-Link master with 8 inputs/outputs, DIN rail, screw terminal
	<b>IO-Link-Master02-USB</b>	IO-Link master, supply via USB port or separate power supply, LED indicators, M12 plug for sensor connection

Release date: 2023-04-05 Date of issue: 2023-04-05 Filename: 267075-100441\_eng.pdf

**Teach-In**

You can use the rotary switch to select the relevant switching threshold A and/or B for teaching in for switch signal **Q1** or **Q2**. The yellow LEDs indicate the current state of the selected output. To store a threshold value, press and hold the "TI" button until the yellow and green LEDs flash in phase (approx. 1 s). Teach-In starts when the "TI" button is released. Successful Teach-In is indicated by alternating flashing (2.5 Hz) of the yellow and green LEDs. An unsuccessful Teach-In is indicated by rapidly alternating flashing (8 Hz) of the yellow and green LEDs. After an unsuccessful Teach-In, the sensor continues to operate with the previous valid setting after the relevant visual fault signal is issued. Different switching modes can be defined by teaching in the relevant distance measured values for the switching thresholds A and B: Single point mode:

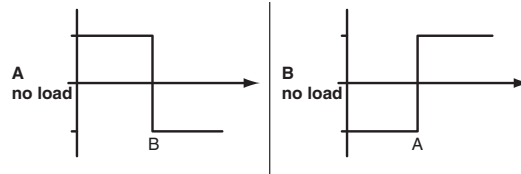

Window mode:

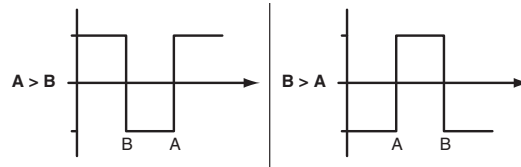

Every taught-in switching threshold can be retaught (overwritten) by pressing the „TI“ button again. Pressing and holding the "TI" button for > 4 s completely deletes the taught-in value. The yellow and green LEDs go out simultaneously to indicate that this procedure has been completed. Successful resetting is indicated by alternating flashing (2.5 Hz) of the yellow and green LEDs.

**Resetting to Factory Default Settings**

Press the „TI“ button for > 10 s in rotary switch position ‚O‘ to reset to factory default settings. The yellow and green LEDs go out simultaneously to indicate the resetting. Resetting process starts when the "TI" button is released and is indicated by the yellow LED. After the process the sensor works with factory default settings, immediately.

OMT:

- Factory default settings switch signal Q1: Switch signal active, window mode
- Factory default settings switch signal Q2: Switch signal active, window mode

OQT:

- Factory default settings switch signal Q1: Switch signal active, BGS mode (background suppression)
- Factory default settings switch signal Q2: Switch signal active, BGS mode (background suppression)

**Configuration**

**Configuring different operating modes via the IO-Link interface**

The devices are equipped with an IO-Link interface as standard for diagnostics and parameterization tasks to ensure optimum adjustment of the sensors to the relevant application. Four different operating modes can be set, among other features:

**Background suppression operating mode (one switch point):**

- Detection of objects irrespective of type and color in a defined detection range. Objects in the background are suppressed.



**Background evaluation operating mode (one switch point):**

- Detection of objects irrespective of type and color against a defined background. Reliable detection of objects at close range

Release date: 2023-04-05 Date of issue: 2023-04-05 Filename: 267075-100441\_eng.pdf

(detection range  $\geq 0$  mm). The background serves as reference.



**Single point mode operating mode (one switch point):**

- Detection of objects irrespective of type and color in a defined detection range. Objects in the background are suppressed.
- The switch point corresponds exactly to the set point.



**Window mode operating mode (two switch points):**

- Detection of objects irrespective of type and color in a defined detection range. Reliable detection when object leaves the detection range.
- Window mode with two switch points.



**Center window mode operating mode (one switch point):**

- Detection of objects irrespective of type and color in a defined detection range. Sets a defined window around a given object. Objects outside this window are not detected.
- Window mode with one switch point.



**Two point mode operating mode (hysteresis operating mode):**

- Detection of objects irrespective of type and color between a defined switch-on and switch-off point.

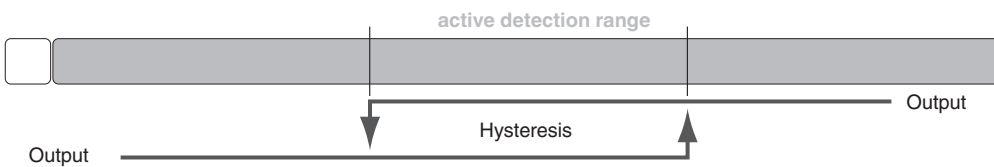

**Inactive operating mode:**

- Evaluation of switching signals is deactivated.

The associated IODD device description file can be found in the download area at [www.pepperl-fuchs.com](http://www.pepperl-fuchs.com).

Release date: 2023-04-05 Date of issue: 2023-04-05 Filename: 267075-100441\_eng.pdf