





## Mass Flow Controller for Gases (MFC)

- Nominal flow ranges from 0.005 I<sub>N</sub>/min to 15 I<sub>N</sub>/min
- High accuracy and repeatability
- Applicable for aggressive gases
- Optional: Fieldbus interface

Product variants described in the data sheet may differ from the product presentation and description.

### Can be combined with

	<b>Type 0330</b> Direct-acting 2/2 or 3/2 way pivoted armature valve	▶
	<b>Type 6013</b> Plunger valve 2/2 way direct-acting	▶
	<b>Type 6027</b> Direct-acting 2/2 way plunger valve	▶

### Type description

The mass flow controller (MFC) Type 8710 is especially suited for regulating the mass flow of aggressive gases, which need a sensor which is not in direct contact with the gas. The thermal capillary sensor reaches fast response times. A direct-acting proportional valve from Bürkert guarantees a high sensitivity. The integrated PI controller ensures outstanding control characteristics of the MFC. Type 8710 can optionally be calibrated for two different gases; the user can switch between these two gases. As electrical interfaces both, analog standard signals and fieldbuses are available.

## Table of contents

<b>1. General data</b>	<b>3</b>
<b>2. Materials</b>	<b>4</b>
2.1. Chemical Resistance Chart – Bürkert resistApp.....	4
<b>3. Dimensions</b>	<b>5</b>
3.1. Standard version.....	5
3.2. Sub-base version.....	6
<b>4. Device/Process connections</b>	<b>7</b>
4.1. Analogue version/Fieldbus version.....	7
<b>5. Product operation</b>	<b>8</b>
5.1. Measuring principle .....	8
5.2. Flow characteristic.....	8
Nominal flow range of typical gases.....	8
<b>6. Ordering information</b>	<b>9</b>
6.1. Bürkert eShop – Easy ordering and quick delivery.....	9
6.2. Recommendation regarding product selection .....	9
6.3. Bürkert product filter.....	9
6.4. Ordering chart accessories.....	10
6.5. Adapter sketch.....	11

## 1. General data

Product properties	
<b>Material</b>	
Basic block	Stainless steel
Body	PC (Polycarbonate) or metal
Seal	FKM, EPDM or FFKM
Dimensions	Detailed information can be found in chapter <b>"3. Dimensions"</b> on page 5.
Total weight	approx. 850 g (stainless steel)
LED display	Indication for power, limit (with analogue signals) / communication (with fieldbus) and error
<b>Performance data</b>	
Nominal flow range ( $Q_{Nom}$ )	5 ml <sub>N</sub> /min...15000 ml <sub>N</sub> /min (N <sub>2</sub> ) Detailed information can be found in chapter <b>"5.2. Flow characteristic"</b> on page 8.
Measuring range	1:50
Max. operating pressure	10 bar (145 psi) (depending on the nominal valve size)
Measuring accuracy	±1.5 % o. R. ±0.3 % F. S. (after 30 min. warm-up time)
Repeatability	±0.1 % F. S.
Response time (t95 %)	<3 sec.
<b>Electrical data</b>	
Operating voltage	24 V DC
Power consumption	Max. 3.5...10 W (depending on the proportional valve used)
Voltage tolerance	±10 %
Residual ripple	<2 %
Electrical connection	Plug D-Sub 15 pin with PROFIBUS DP: M12-Socket, 5 pin with CANopen: M12-Plug, 5 pin
<b>Medium data</b>	
Operating medium	Neutral, or aggressive gases
Calibration medium	Operating gas or air (with conversion factor)
Medium temperature	-10 °C...+70 °C (-10 °C...+60 °C for oxygen)
<b>Process/Port connection &amp; communication</b>	
Port connection	NPT ¼, G ¼, screw-in fitting or sub-base, others on request
Fieldbus option	PROFIBUS-DP, CANopen
Digital outputs	Relay-output for setpoint not reached, Load capacity: 25 V, 1 A, 25 VA
Digital inputs	Two 1. Start Autotune 2. Not assigned
Digital (communication) interface	RS232, Modbus RTU (via RS-Adapter) RS485, RS422 or USB (see <b>"6.4. Ordering chart accessories"</b> on page 10)
Analogue interfaces	4...20 mA, 0...20 mA, 0...10 V or 0...5 V Input impedance >20 kΩ (Voltage) resp. <300 Ω (Current) Max. load: 10 mA (Voltage output); max. load: 600 Ω (Current output)
<b>Environment and installation</b>	
Installation position	Horizontal or vertical
Degree of protection	IP40
<b>Accessories</b>	
Software-Tool	Mass Flow Communicator

- 1.) The nominal flow value is the max. flow value calibrated which can be measured.  
The nominal flow range defines the range of nominal flow rates (full scale values) possible.
- 2.) Index N: Flow rates referred to 1.013 bar and 0 °C. Alternatively there is an  
Index S available which refers to 1.013 bar and 20 °C.

## 2. Materials

### 2.1. Chemical Resistance Chart – Bürkert resistApp



#### **Bürkert resistApp – Chemical Resistance Chart**

You want to ensure the reliability and durability of the materials in your individual application case? Verify your combination of media and materials on our website or in our resistApp.

[Start Chemical Resistance Check](#)

### 3. Dimensions

#### 3.1. Standard version

**Note:**

Dimensions in mm

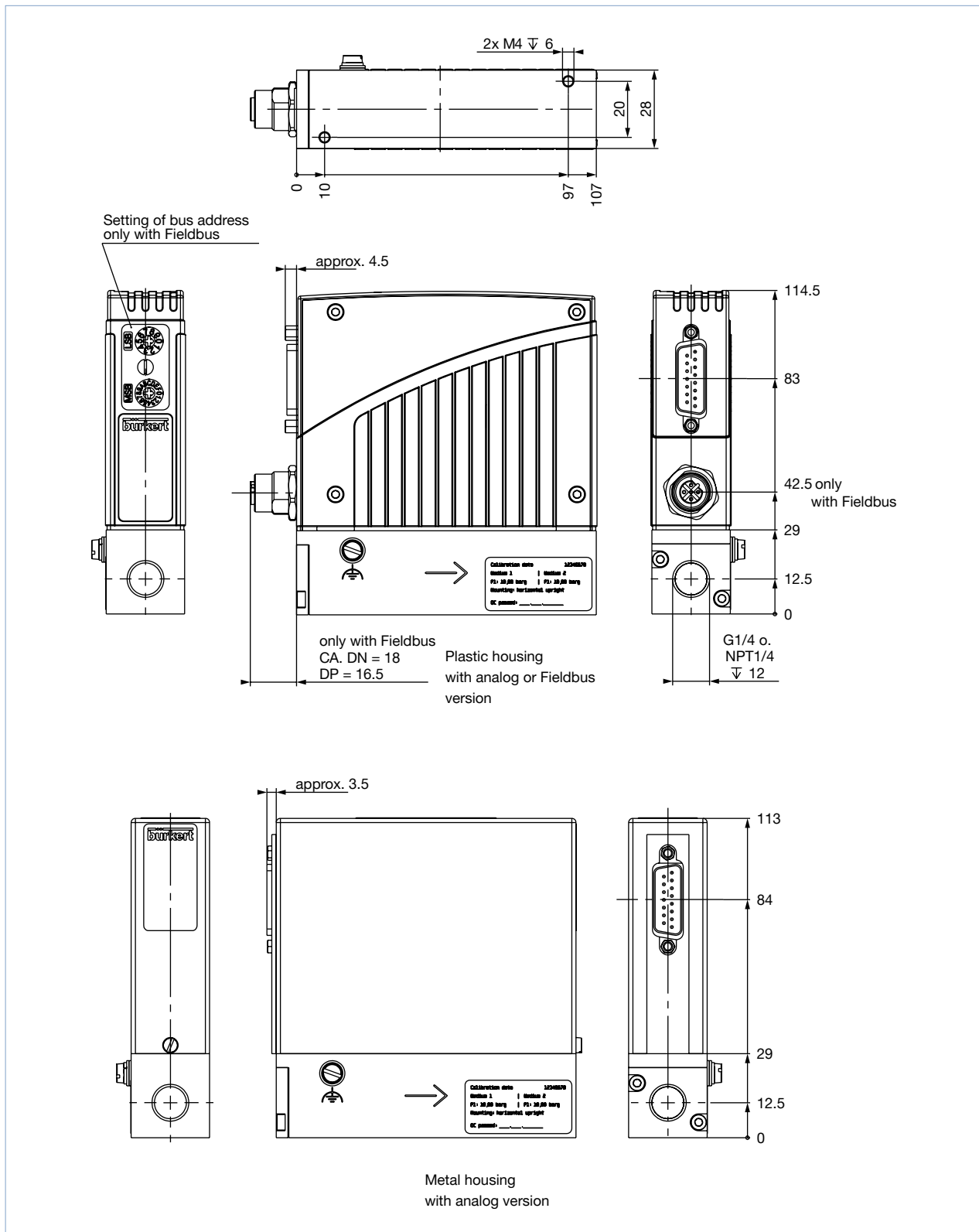

DTS 1000095464 EN Version: J Status: RL (released | freigegeben | valide) printed: 26.03.2021

### 3.2. Sub-base version

**Note:**

Dimensions in mm

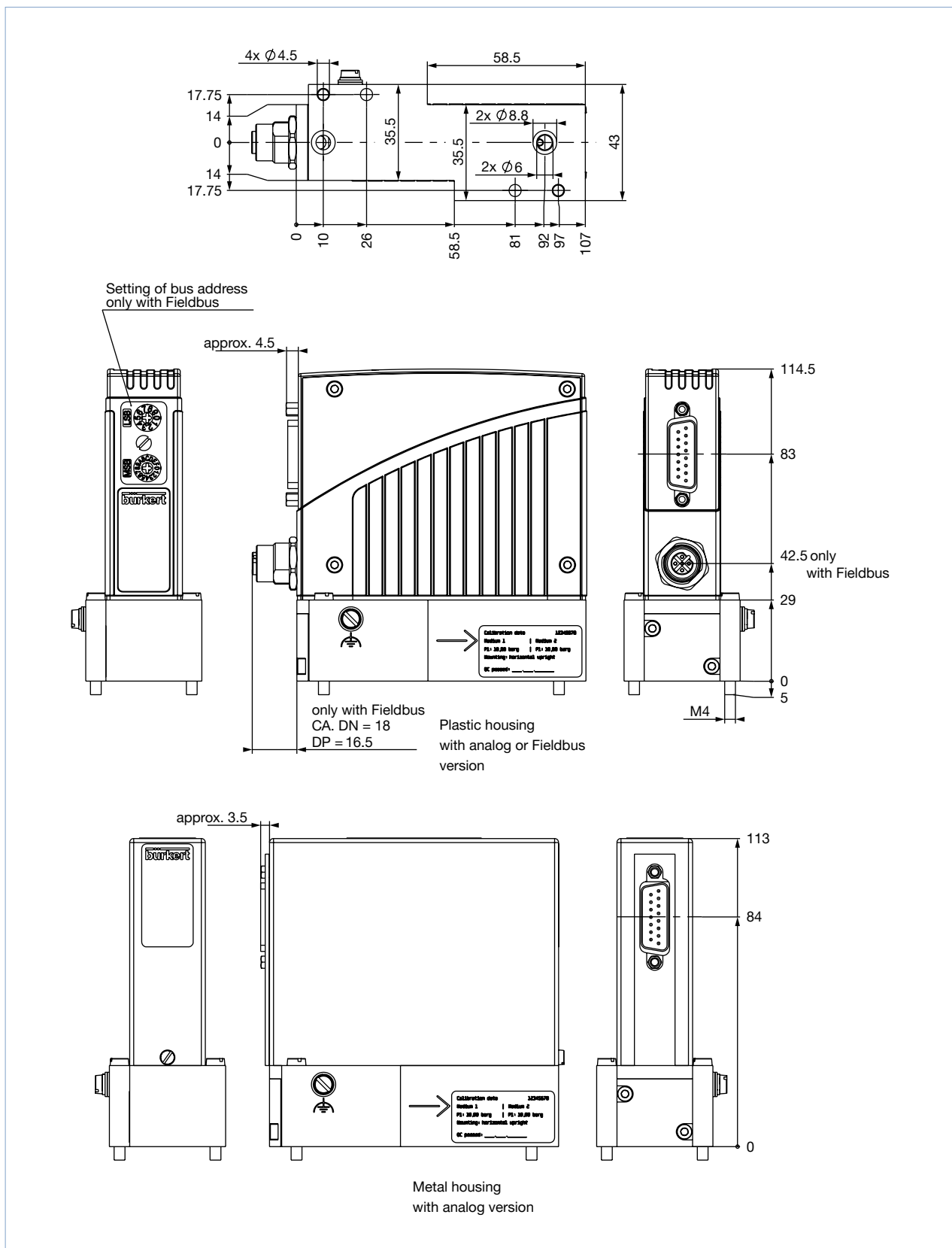

DTS 1000095464 EN Version: J Status: RL (released | freigegeben | valide) printed: 26.03.2021

## 4. Device/Process connections

### 4.1. Analogue version/Fieldbus version

**Note:**

- Optional Pin 7 and 8 with bus version as transmitter input possible.
- The cable length for RS232/actual value signal is limited to 30 meters.

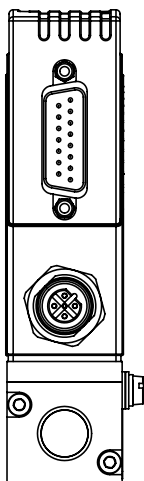
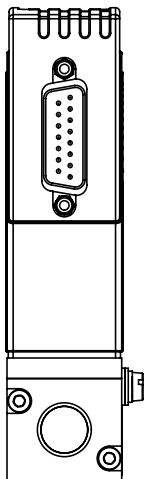

#### Analogue version

Plug D-Sub, 15 pin	Pin	Assignment	
		Analogue control unit	Bus actuation
	1	Relay – normally closed	
	2	Relay – normally open	
	3	Relay – middle contact	
	4	GND for 24 V-supply and binary inputs	
	5	24 V-supply +	
	6	Only for internal company use	
	7	Not connected	Not connected
	8	Not connected	Not connected
	9	Actual value output GND	Not connected
	10	Actual value output +	Not connected
	11	DGND (for RS232) <sup>1.)</sup>	
	12	Binary input 1	
	13	Binary input 2	
	14	RS232 RxD (without driver) <sup>1.)</sup>	
	15	RS232 TxD (without driver) <sup>1.)</sup>	

1.) Driving RS232 interface only by RS232 adapter including an adaption of TTL levels

#### Fieldbus version

PROFIBUS DP – socket B-coded M12 (DPV1 max. 12 MBaud)	Pin	Assignment
	1	VDD (only for termination resistor)
	2	RxD/TxD – N (A-Line)
	3	DGND
	4	RxD/TxD – P (B-Line)
	5	Not connected

CANopen – Plug M12	Pin	Assignment
	1	Shield
	2	Not connected
	3	DGND
	4	CAN_H
	5	CAN_L

## 5. Product operation

### 5.1. Measuring principle

The measurement is based on the bypass principle. A laminar flow element in the main channel generates a small pressure drop. This drives a small flow, proportional to the main flow, through the bypass (sensor tube).

Two heating resistors, which are connected in a measuring bridge, are wound on this stainless steel tube. In the zero-flow state, the bridge is balanced, but with flow, heat is transported in the flow direction and the bridge becomes unbalanced.

The dynamics of the measurement is limited by the tube walls, which act as a thermal barrier.

With contaminated gases we recommend to install filter elements upstream. This avoids changes in the division ratio between main flow and sensor tube, as well as changes in the heat transmission caused by deposits on the walls of the sensor tube.

With these sensors even aggressive gases can be measured, because all essential parts in contact with the gas are fabricated in stainless steel. With this sensor principle it is also possible to convert between different gases.

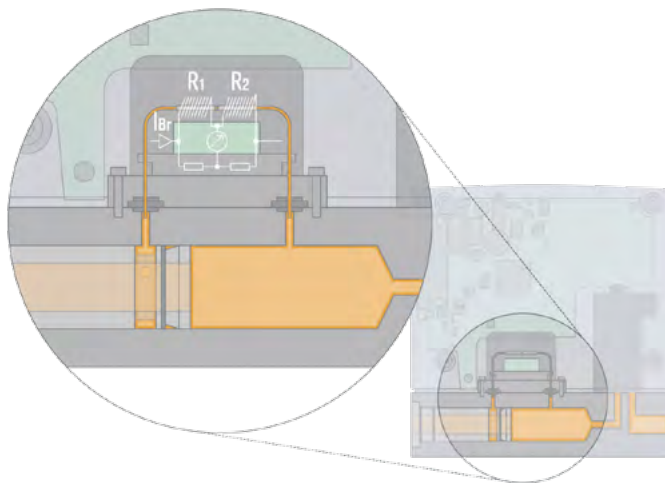

### 5.2. Flow characteristic

#### Nominal flow range of typical gases

##### Note:

- $Q(\text{Gas}) = f \times Q(\text{N}_2)$
- By using the gas factors it is possible that the accuracy is not within the datasheet specification. or applications which need high accuracy it is recommended to calibrate under application conditions.
- The compatibility of the sealing materials of the MFMs should be checked before use with another gas.

Gas	Faktor f
N <sub>2</sub>	1.00
Air	1.00
O <sub>2</sub>	0.98
H <sub>2</sub>	1.01
Ar	1.4
He	1.42
CO <sub>2</sub>	0.77



## 6. Ordering information

### 6.1. Bürkert eShop – Easy ordering and quick delivery



#### Bürkert eShop – Easy ordering and fast delivery

You want to find your desired Bürkert product or spare part quickly and order directly? Our online shop is available for you 24/7. Sign up and enjoy all the benefits.

[Order online now](#)

### 6.2. Recommendation regarding product selection

#### Note:

Please use the „**Product Enquiry Form**“ at the end of this document for unit design details and send us a copy of the enquiry with information about the application.

For the proper choice of the actuator orifice within the MFC, not only the required maximum flow rate  $Q_{Nom}$ , but also the pressure values directly before and after the MFC ( $p_1$ ,  $p_2$ ) at this flow rate  $Q_{Nom}$  should be known. In general, these pressures are not the same as the overall inlet and outlet pressures of the whole plant, because usually there are additional flow resistors (tubing, additional shut-off valves, nozzles etc.) present both before and after the controller.

Please use the „**Product Enquiry Form**“ at the end of this document to indicate the pressures directly before and after the MFC. If these should be unknown or not accessible to a measurement, estimates are to be made by taking into account the approximate pressure drops over the flow resistors before and after the MFC, respectively, at a flow rate of  $Q_{Nom}$ . In addition, please quote the maximum inlet pressure  $p_{1, max}$  to be encountered. This data is needed to make sure the actuator is able to provide a close-tight function within all the specified modes of operation.

### 6.3. Bürkert product filter



#### Bürkert product filter – Get quickly to the right product

















You want to select products comfortably based on your technical requirements? Use the Bürkert product filter and find suitable articles for your application quickly and easily.

[Try out our product filter](#)

#### 6.4. Ordering chart accessories

**Note:**

The adapters serve mainly for initial operation or diagnosis. Those are not obligatory for continuous operation.

Description	Article no.
<b>Connections/Cables</b>	
Socket D-Sub 15 pin solder connection	918274 
Hood for D-Sub socket, with screw locking	918408 
Socket D-Sub 15 pin with 5 m cable	787737 
Socket D-Sub 15 pin with 10 m cable	787738 
<b>Adapters<sup>1.)</sup></b>	
RS232 adapter	654748 
PC extension cable for RS232 9 pin socket/plug 2 m	917039 
RS422 adapter (RS485 compatible)	666371 
USB adapter (Version 1.1, USB socket type B)	670639 
USB connection cable 2 m	772299 
Communication software Mass Flow Communicator	<b>LINK ▶</b>
<b>Accessories for Fieldbus</b>	
<b>PROFIBUS-DP (B-coded)</b>	
Plug M12 <sup>2.)</sup>	918198 
Socket M12 (coupling) <sup>2.)</sup>	918447 
Y-junction <sup>2.)</sup>	902098 
Termination resistor	902553 
GSD-File (PROFIBUS), EDS-File (CANopen)	<b>LINK ▶</b>
<b>CANopen (A-coded)</b>	
Plug M12 <sup>2.)</sup>	917115 
Socket M12 (coupling) <sup>2.)</sup>	917116 
Y-junction <sup>2.)</sup>	788643 
Termination resistor	On request
GSD-File (PROFIBUS), EDS-File (CANopen)	<b>LINK ▶</b>

1.) The adapters serve mainly for initial operation or diagnosis. Those are not obligatory for continuous operation.

2.) The M12 single connectors as listed here are not suitable for their simultaneous use with the Y-piece for reasons of space. Please always use at least one commercially available overmoulded cable whose connector is usually smaller.

6.5. Adapter sketch

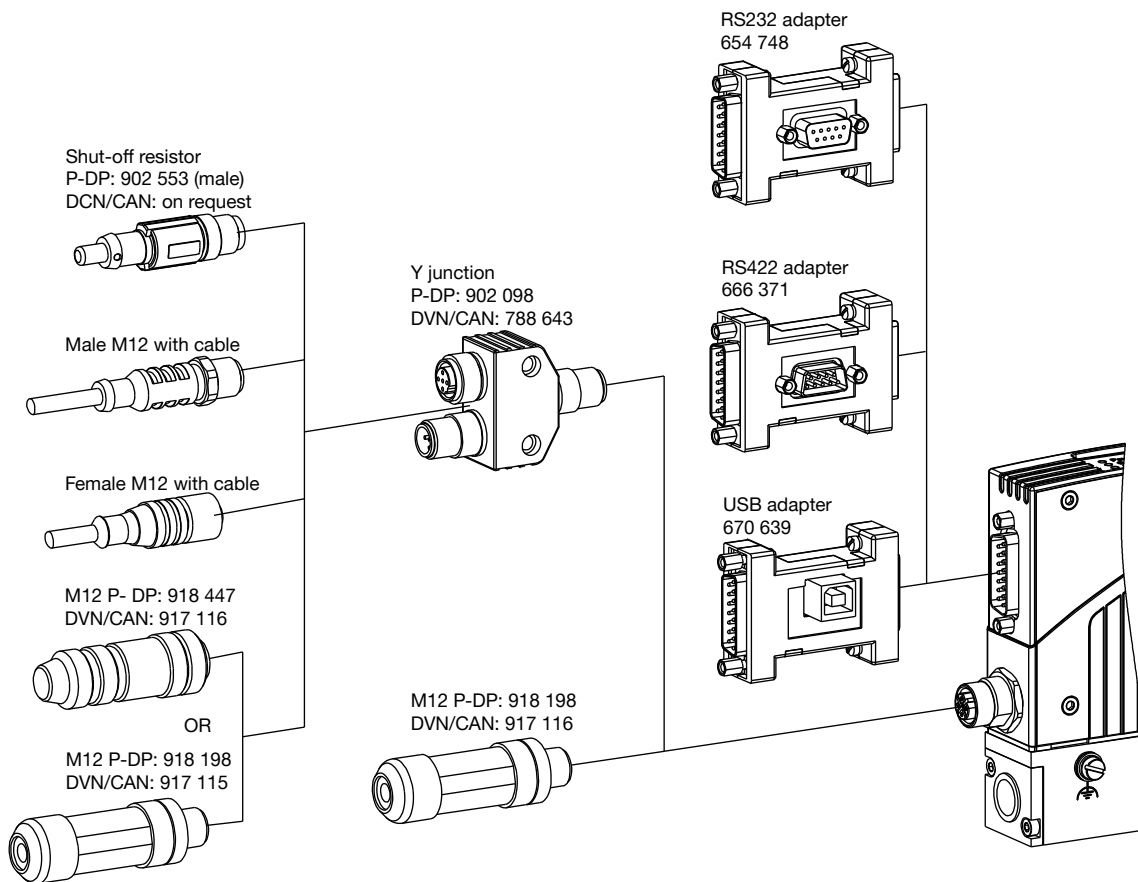

DTS 1000095464 EN Version: J Status: RL (released | freigegeben | valide) printed: 26.03.2021

# Bürkert – Close to You

For up-to-date addresses  
please visit us at  
[www.burkert.com](http://www.burkert.com)

DTS 1000095464 EN Version: J Status: RL (released | freigegeben | validé) printed: 26.03.2021



## Product Enquiry Form - Mass Flow Controller For Gases

Thank you for your interest in our products! In order to provide you with optimum advice, please fill out the following form and send it to your **Bürkert representative** or e-mail address: [info@burkert.com](mailto:info@burkert.com). All information submitted will of course be kept strictly confidential.

Please fill in the **required fields!**  \*

\*Note: The interactive functions of this PDF may be restricted depending on the PDF reader used.

Personal Information			
Company		Contact person	
Customer no.		Department	
Street		Postcode / Town	
Telephone no.		Email	

Delivery			
MFC Application	MFM Application	Quantity	Required delivery date

Medium data			
Type of gas or gas mixture			
Medium temperature		°C /	°F
Ambient temperature		°C /	°F

Fluidic data					
Flow range $Q_{Nom}$		Min.		Max.	unit Ref. N <sup>1.)</sup> Ref. S <sup>1.)</sup>
Inlet pressure at $Q_{Nom}$ <sup>2.)</sup>	$p_1$	=		barg <sup>3.)</sup>	
Outlet pressure at $Q_{Nom}$	$p_2$	=		barg <sup>3.)</sup>	
Max. inlet pressure	$p_{1max}$	=		barg <sup>3.)</sup>	
Port connection	<b>Compression fitting</b>		<b>Subbase</b>	<b>Vacuum fitting</b>	
	Thread:		G (DIN ISO 228/1)	NPT (ANSI B1.2)	
			1/4" 3/8"	1/2" 3/4"	1"
Installation	horizontal, valve upright			vertical, upward flow	
	horizontal, valve horizontal			vertical, downward flow <sup>4.)</sup>	

1.) Reference conditions: Ref. N: T=0°C, P=1,013 bar(a); Ref. S: T=20°C, P=1,013 bar(a)

2.) Corresponds to the calibration pressure

3.) Please indicate all pressure values as overpressure to atmospheric pressure [barg] (g = relative pressure)

4.) Possible reduction of the setting range to 1:10 for a vertical downwards flow

Material specifications		
Body	Aluminium	Stainless steel
Seals	FKM	EPDM

Electrical data				
IP protection	Yes (IP65)		No (IP20 or better)	
Control / Communication Note: Please choose <b>one</b> of the following options!	Normsignal	CANopen/büS	PROFIBUS DP	Industrial Ethernet
	0 ... 5 V	CANopen		PROFINET
	0 ... 10 V	büS		Ethernet IP
	0 ... 20 mA			Modbus TCP
Connection Note: Please choose <b>one</b> of the following options!	4 ... 20 mA			EtherCAT
	D Sub socket	M12 socket	D Sub socket	(RJ45 always standard)
	Terminal block	Terminal block	M12 socket	

<b>Approvals / Conformities</b>
UL
ATEX II Cat. 3 G/D, IECEx
USP Class VI conformity
FDA conformity
EG 1935/2004 conformity

<b>Additional Requirements / Comment</b>

DTS 1000095464 EN Version: J Status: RL (released | freigegeben | validé) printed: 26.03.2021